

Modern photovoltaic technologies

Course code: PHYS-609

Doctoral program: EDPO - Photonics 2023

EPFL, 12-16 June 2023

Lecturers:

Dr. Franz-Josef HAUG

Dr. Jakob HEIER

Dr. Yaroslav ROMANYUK

Part 1.1 Introduction into PV

- Solar energy and photovoltaics
- Semiconductor physics
- Solar cell parameters

Dr. Yaroslav Romanyuk
Laboratory for Thin films and Photovoltaics
Empa – Swiss Federal Laboratories for Materials Science and Technology
yaroslav.romanyuk@empa.ch

Solar energy and photovoltaics

Solar energy

Humanity's Top Ten Problems for next 50 years

1. ENERGY
2. WATER
3. FOOD
4. ENVIRONMENT
5. POVERTY
6. TERRORISM & WAR
7. DISEASE
8. EDUCATION
9. DEMOCRACY
10. POPULATION



2003	6.3	Billion People
2050	8-10	Billion People

Source Richard Smalley Energy & Nanotechnology Conference
Rice University, Houston May 3, 2003

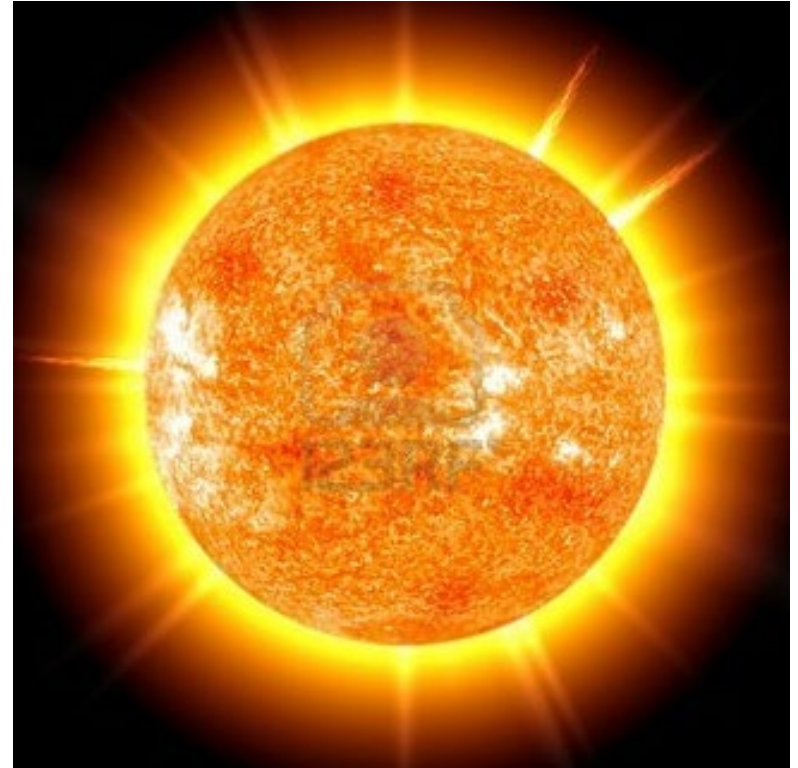

Solar energy received by the Earth within **one hour**
equals the world electricity consumption in **one year**
(26,700 TWh in 2018)

Solar irradiation

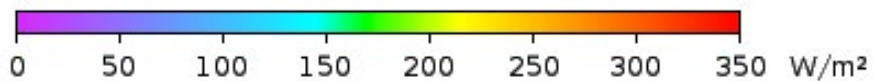
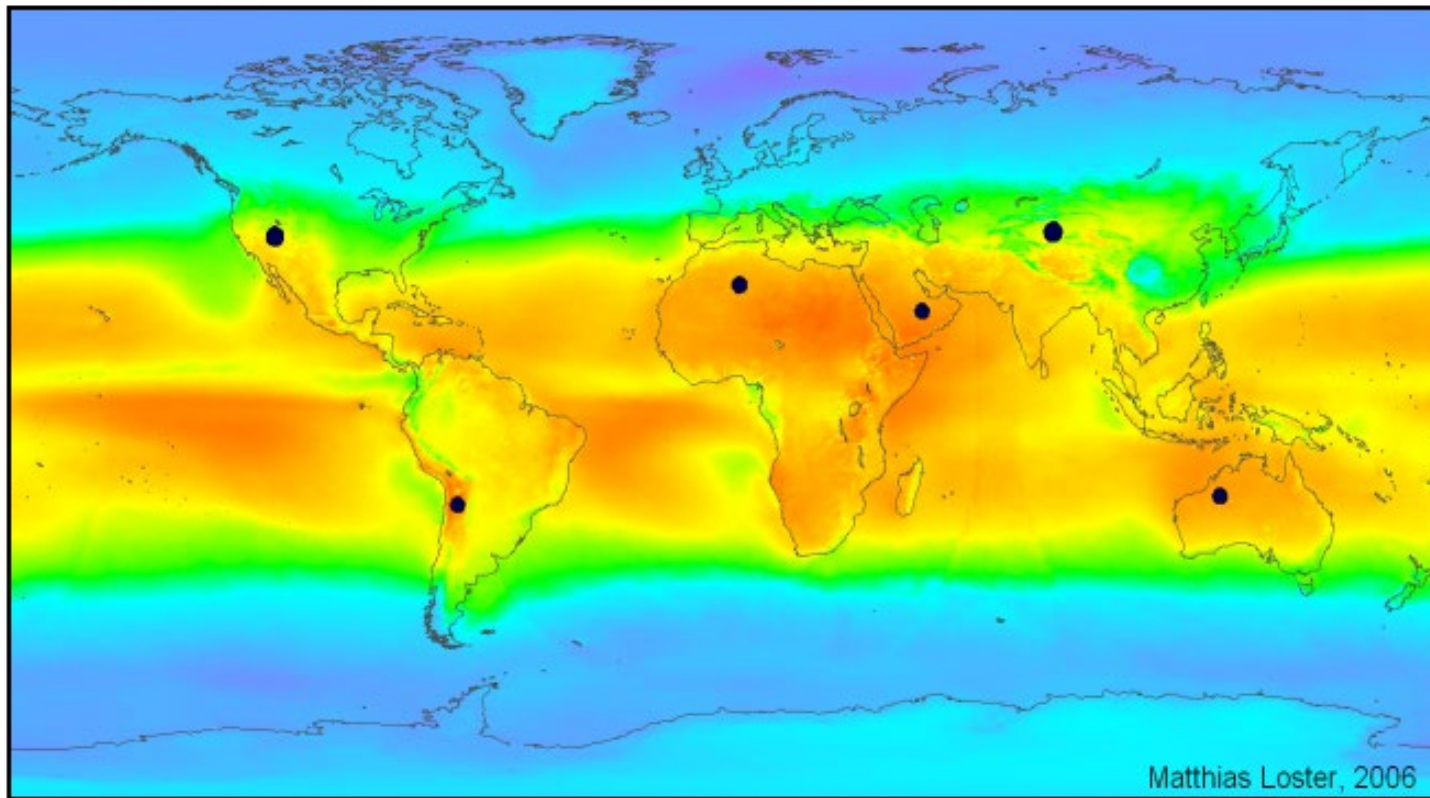

$\Sigma \bullet = 18 \text{ TWe}$

http://en.wikipedia.org/wiki/Solar_energy

- 4% of existing desert area can provide PV power equivalent to the world energy consumption

Solar radiation in Europe

Global horizontal irradiation

Europe

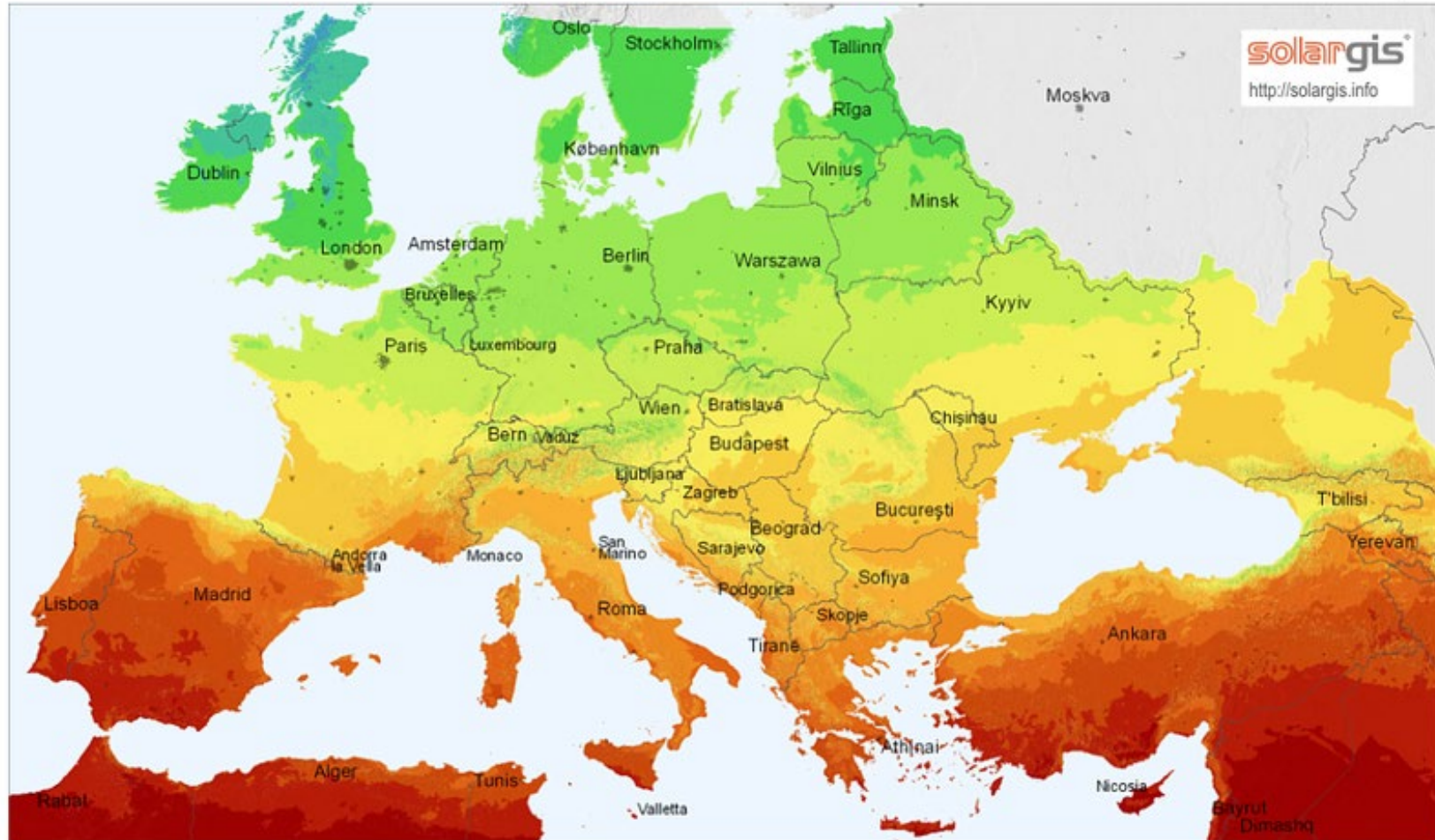

Average annual sum (4/2004 - 3/2010)



0 250 500 km

© 2011 GeoModel Solar s.r.o.

In Switzerland

SOLAR RESOURCE MAP

GLOBAL HORIZONTAL IRRADIATION SWITZERLAND

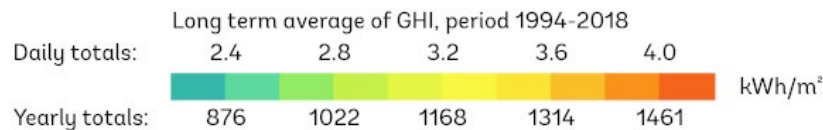
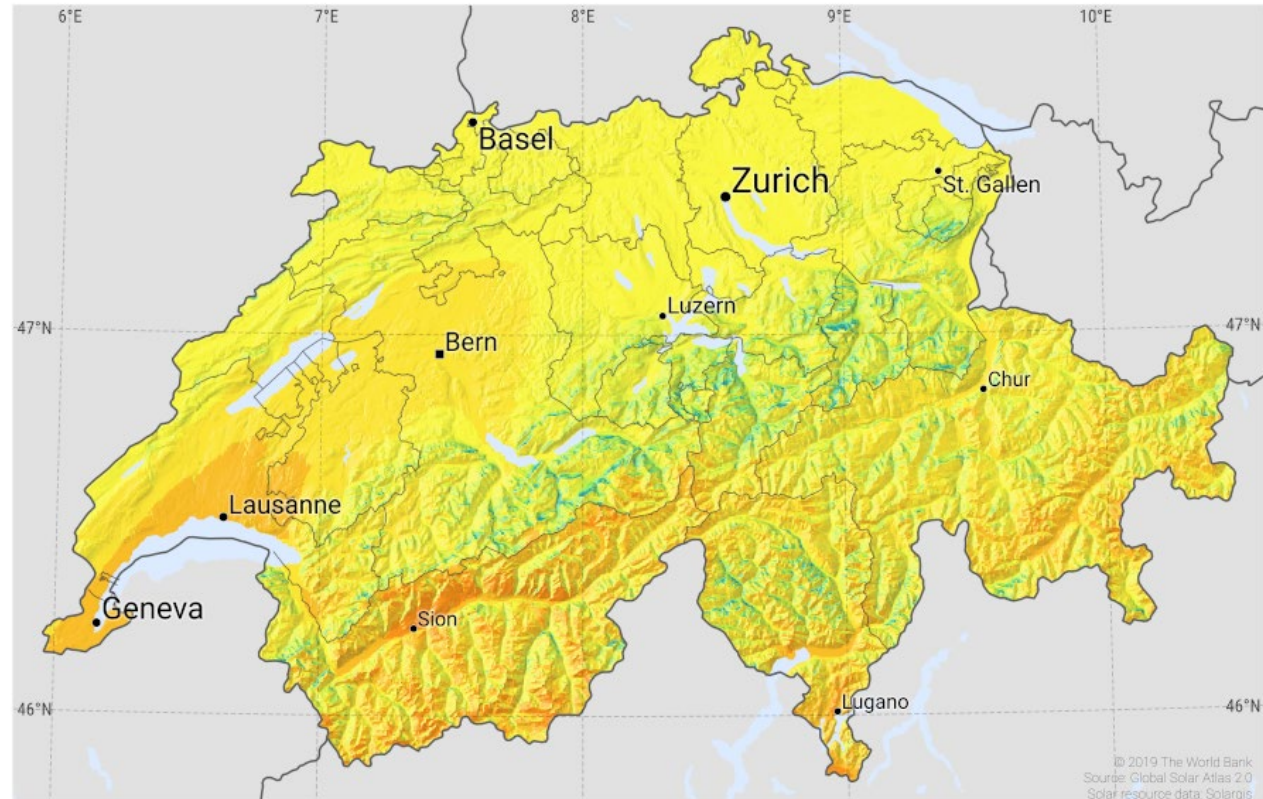

This map is published by the World Bank Group, funded by ESMAP, and prepared by Solargis. For more information and terms of use, please visit <http://globalsolaratlas.info>.

Solar radiation

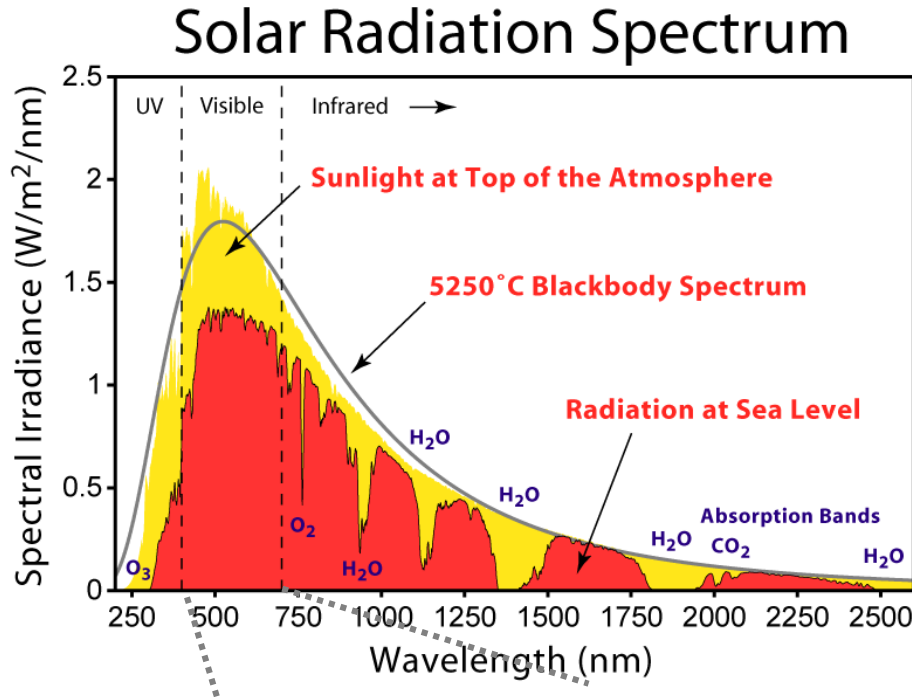

$$\text{Photon Energy} = h\nu = \frac{hc}{\lambda}$$

ν – frequency, λ - wavelength
 h = Planck constant = 6.6×10^{-34} J s
 c = speed of light = 3×10^8 m s⁻¹

$$E_{\text{photon}} [\text{eV}] = \frac{1240}{\lambda [\text{nm}]}$$

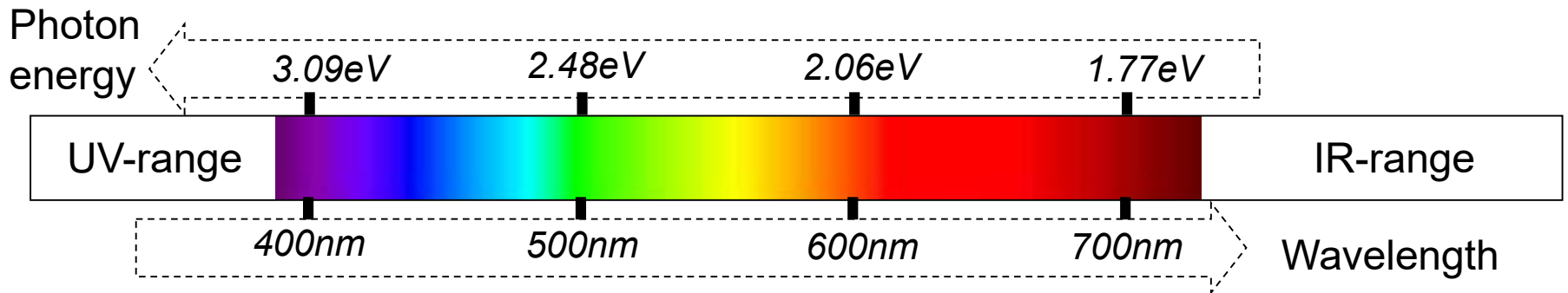

Air mass (AM) coefficient

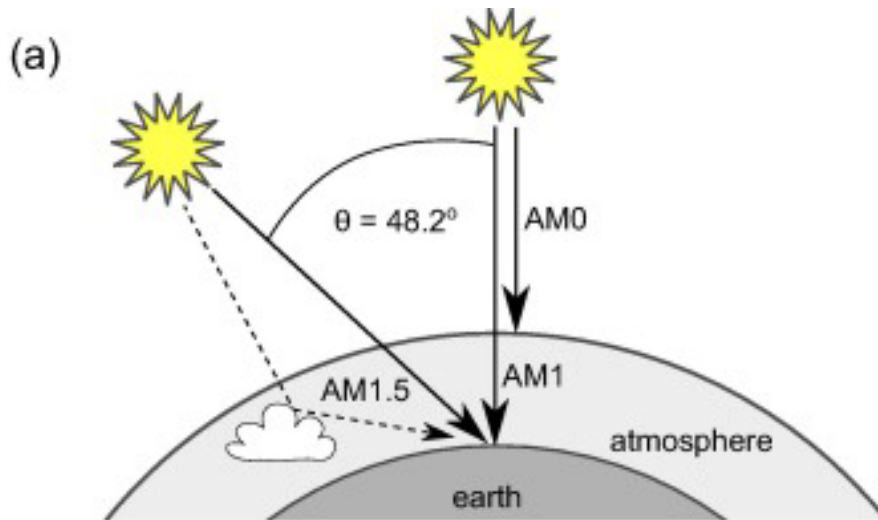

$AM = 1/\cos z$, where z is the angle between sun and the normal

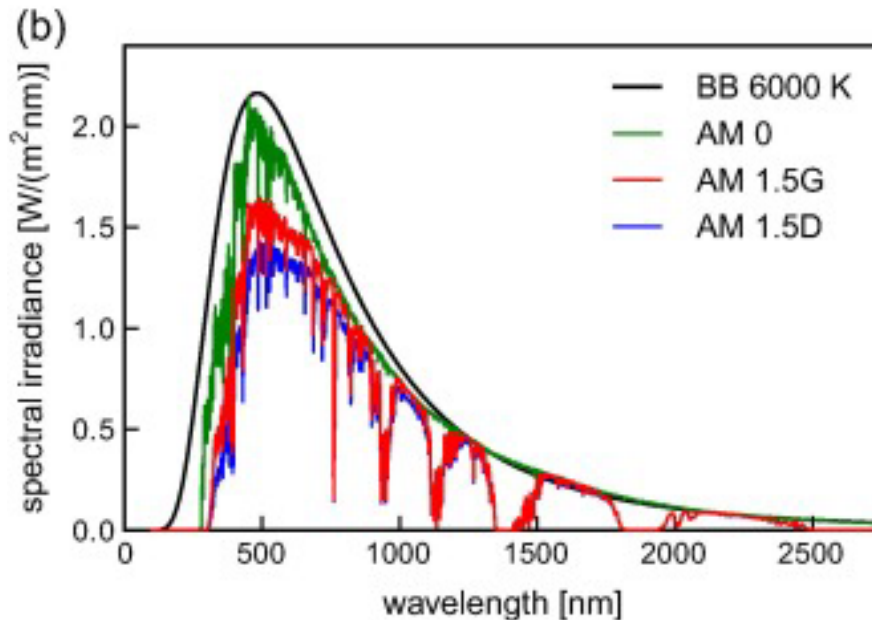

Black body: spectrum at 6000 K

AM 0 spectrum: outside Earth atmosphere

AM 1.5G (global) at zenith angle of 48.2° (realistic for central Europe)

AM 1.5D (direct only)

Solar cell (photovoltaic cell)

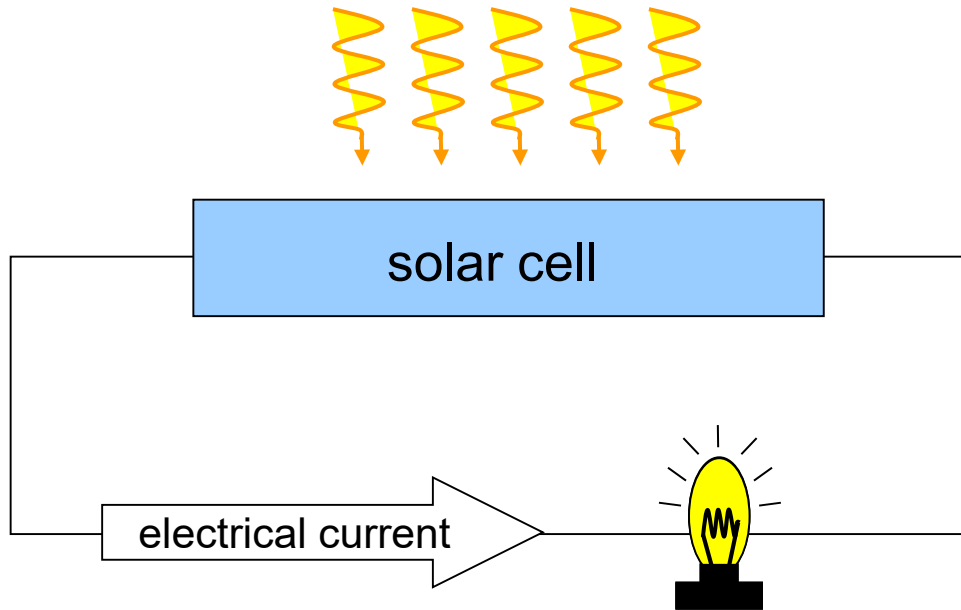

- Solar cell is a device that converts the **light energy directly into electricity** by the photovoltaic effect
- Most solar cell use **semiconductors**: Si, GaAs, CuInSe_2 , CdTe, etc., which can be crystalline, polycrystalline, amorphous

Brief history of photovoltaics

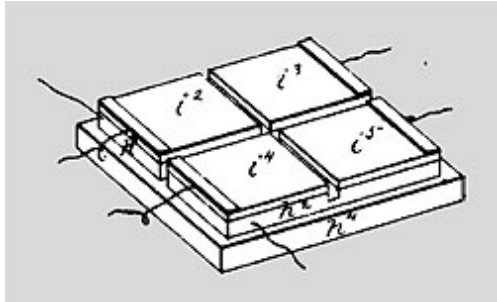

From a patent application in 1884

1883 First solar cell made of selenium crystal and a layer of gold by Charles Edgar Fritts, efficiency 1%

1954 First Si cell, Bell Labs (US) efficiency 6%



Vanguard 1, 1958-1964

1958 PV-powered satellite Vanguard 1 (US)

1973 World energy crisis

1989 1`000 rooftops in Germany

1997 100`000 rooftops in Germany

2011 Fukushima disaster,
Swiss Energy Strategy 2050



Semiconductor physics

Solar cell and photovoltaic effect

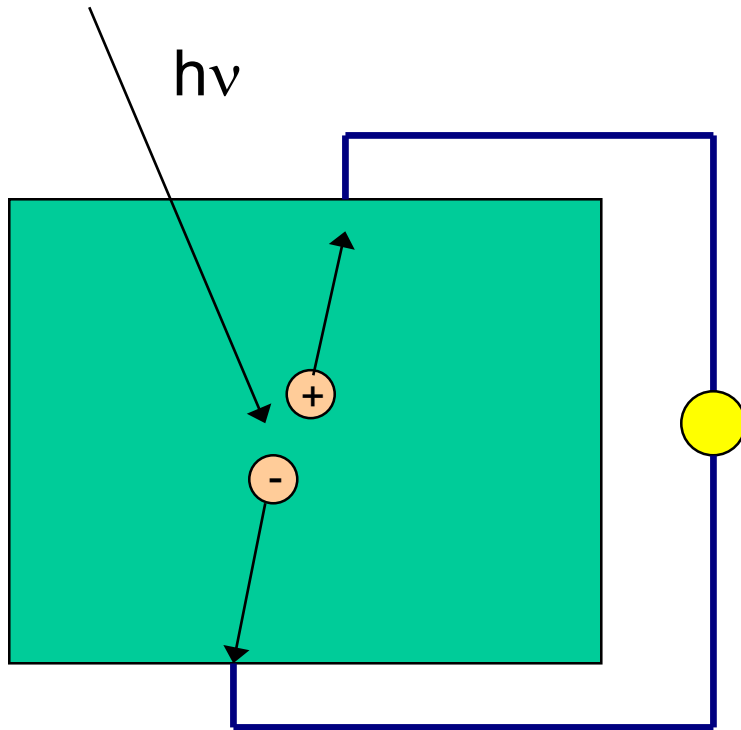

1. Light absorption
2. Generation of „free“ charge carriers
3. Separation of the charges

Source: Dr. Karl Molter / FH Trier, Clemson Summer School 2011

Photogeneration

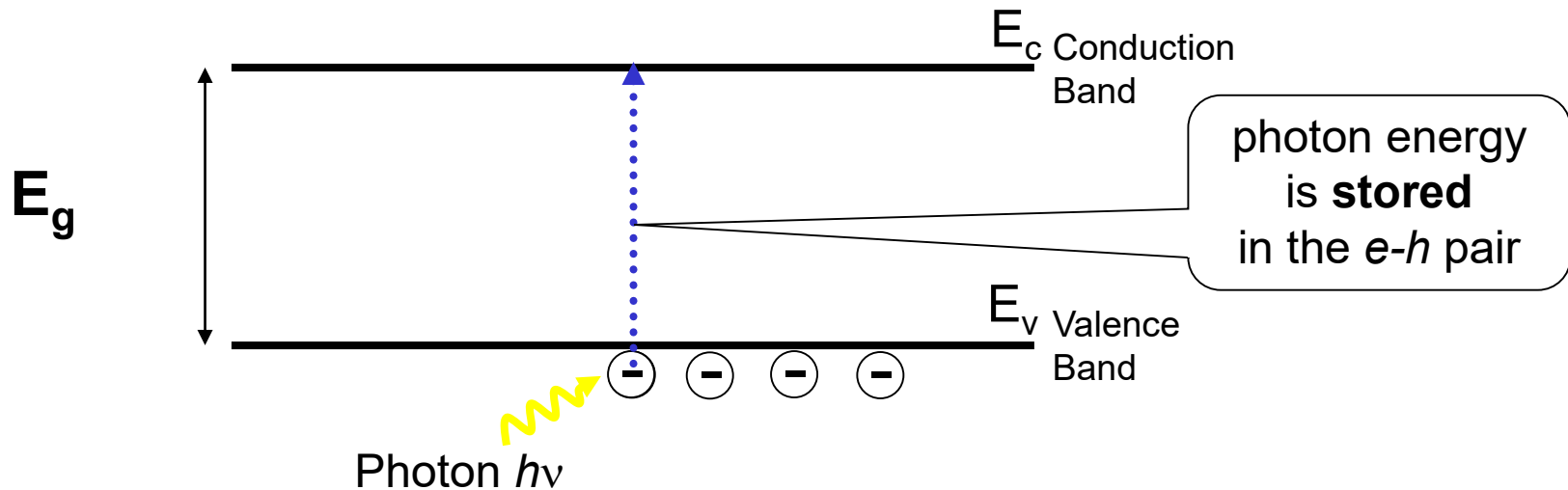

Absorption of photon \Rightarrow Generation of electron-hole pair

Band gap determines absorption:

- Only photons with energy larger than band gap can generate e-h pair:
- \Rightarrow semiconductor absorbs if $l \leq l_c$
- \Rightarrow semiconductor is transparent to $l \geq l_c$

$$E_{\text{photon}} \geq E_g = h\nu_c = \frac{hc}{\lambda_c}$$

ν_c = cut off frequency

λ_c = cut off wavelength

Direct vs Indirect bandgap

$E_g(\text{GaAs}) = 1.42\text{eV}$
direct gap (strong)

$E_g(\text{Si}) = 1.12\text{eV}$
indirect gap (weak)

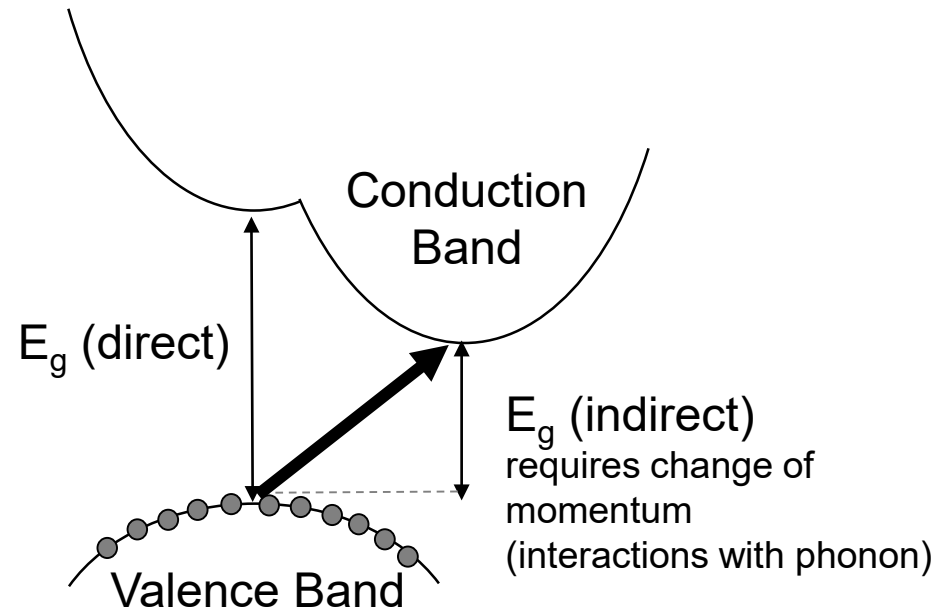
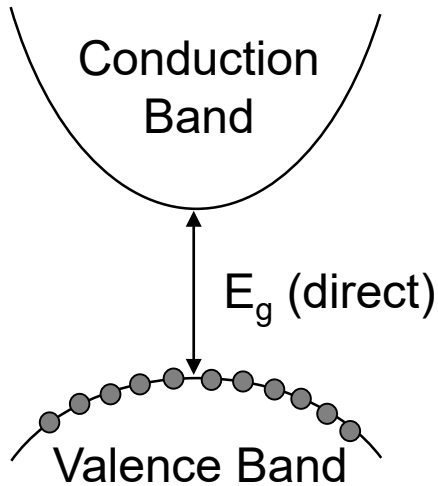

k -vector
(momentum direction)

Light absorption in semiconductors

Direct bandgap

(GaAs, CdTe, a-Si):

⇒ thin layer of 1-2 μm
enough for absorption

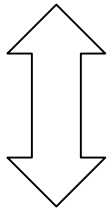

Indirect bandgap (c-Si):

⇒ thick wafer 100 μm needed
for absorption

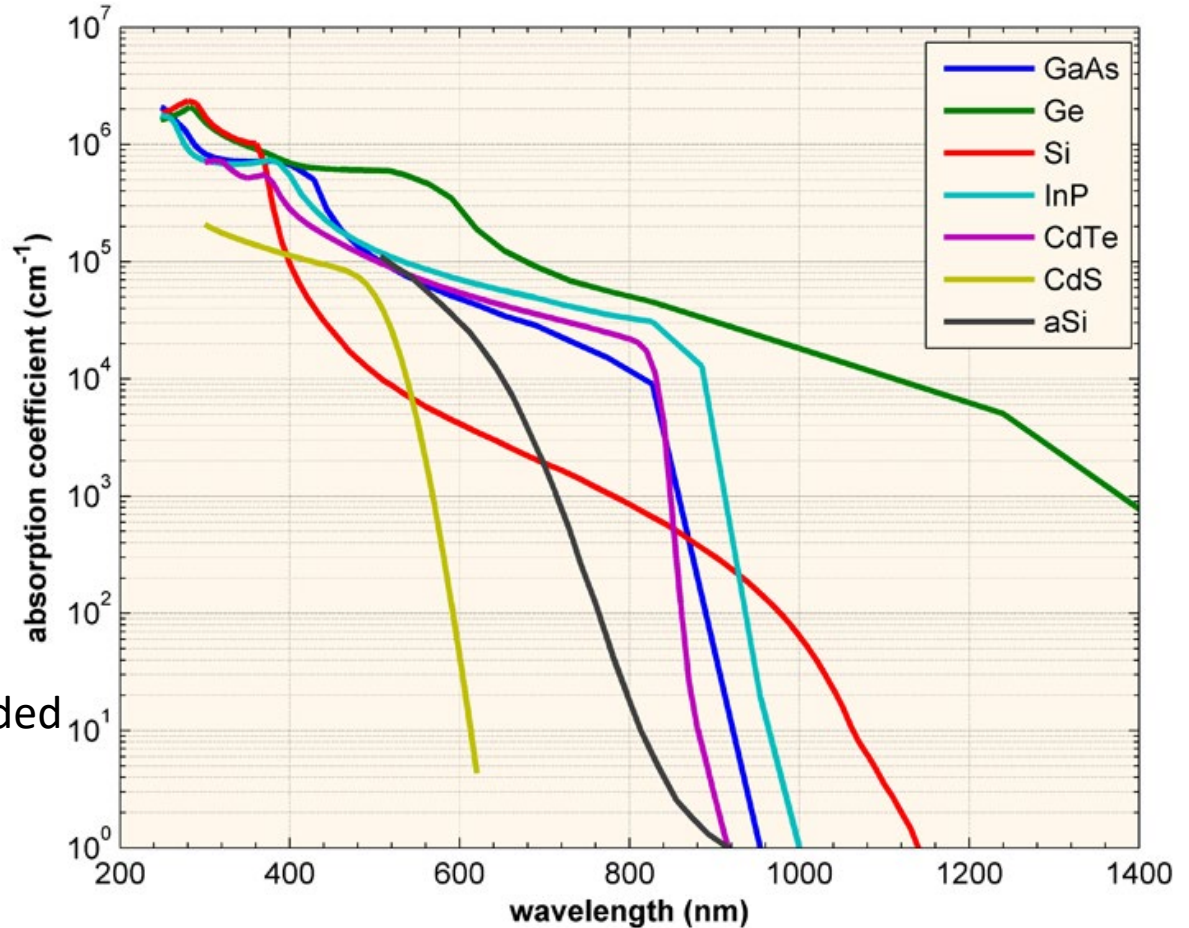

Wide bandgap (a-Si, CdTe):

⇒ better response for
«blue» photons

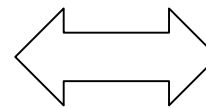

Low band-gap (Ge, Si):

⇒ collection of
IR photons

Optical Absorption

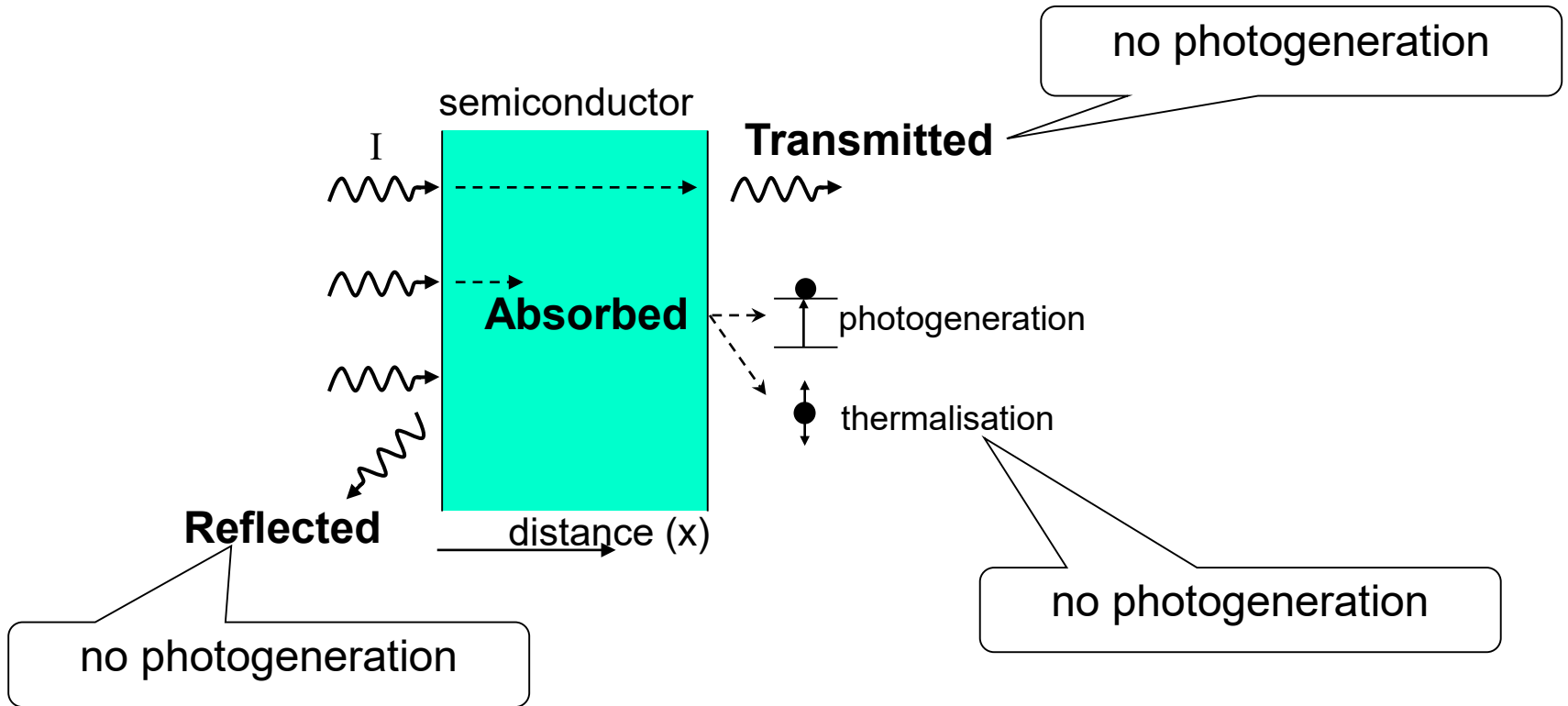

Reflection: R (%)

Transmission: T (%)

Absorption: absorption coefficient α (cm^{-1})

Recombination

Radiative (emit photon)

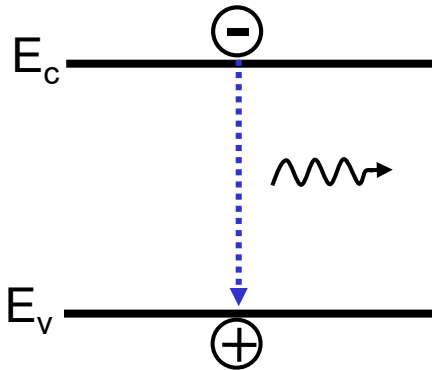

Non-radiative (via defects)

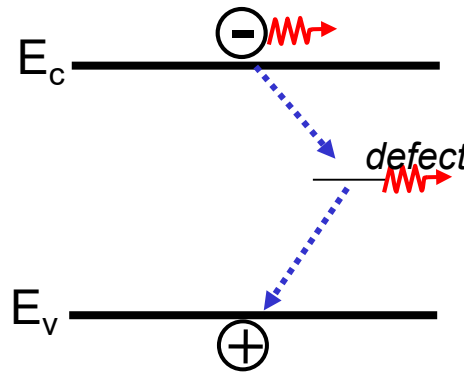

Auger

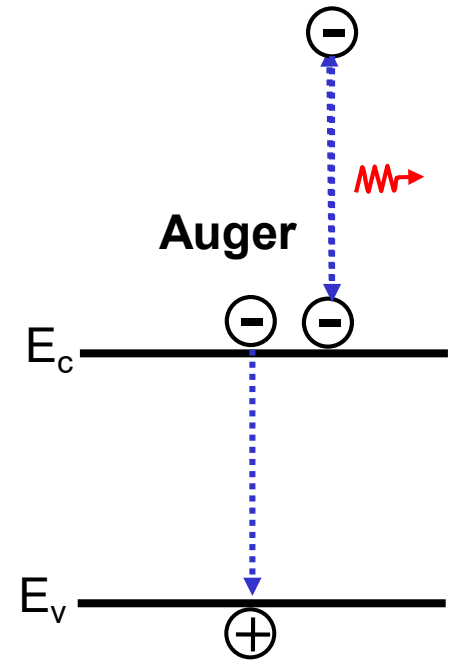

Recombination mechanisms:

1. **Radiative** (emission of photons = photoluminescence)
2. **Non-radiative** (Shockley-Read-Hall or SRH)
3. **Auger** (energy transfer to another electron)

Undesirable in solar cells

Carrier lifetime and diffusion length

$$\tau = \frac{\Delta n}{R}$$

τ – lifetime

Δn – excess minority carrier concentration

R – recombination rate

$$\frac{1}{\tau_{bulk}} = \frac{1}{\tau_{Band}} + \frac{1}{\tau_{Auger}} + \frac{1}{\tau_{SRH}}$$

τ_{bulk} – bulk lifetime

τ_{Band} – radiative band-to-band lifetime

τ_{Auger} – Auger recombination lifetime

τ_{SRH} – defect recombination lifetime

- **Lifetime is an indicator of the efficiency of a solar cell - the key consideration in choosing materials for solar cells.**

$$L = \sqrt{D\tau}$$

L – diffusion length (m)

D – diffusivity bulk lifetime (m^2/s)

τ – carrier lifetime (s)

Carrier mobility

$$\mu = \frac{v_d}{E}$$

μ – carrier mobility ($\text{m}^2/(\text{Vs})$)

v_d – drift velocity (m/s)

E – applied electric field (V/m)

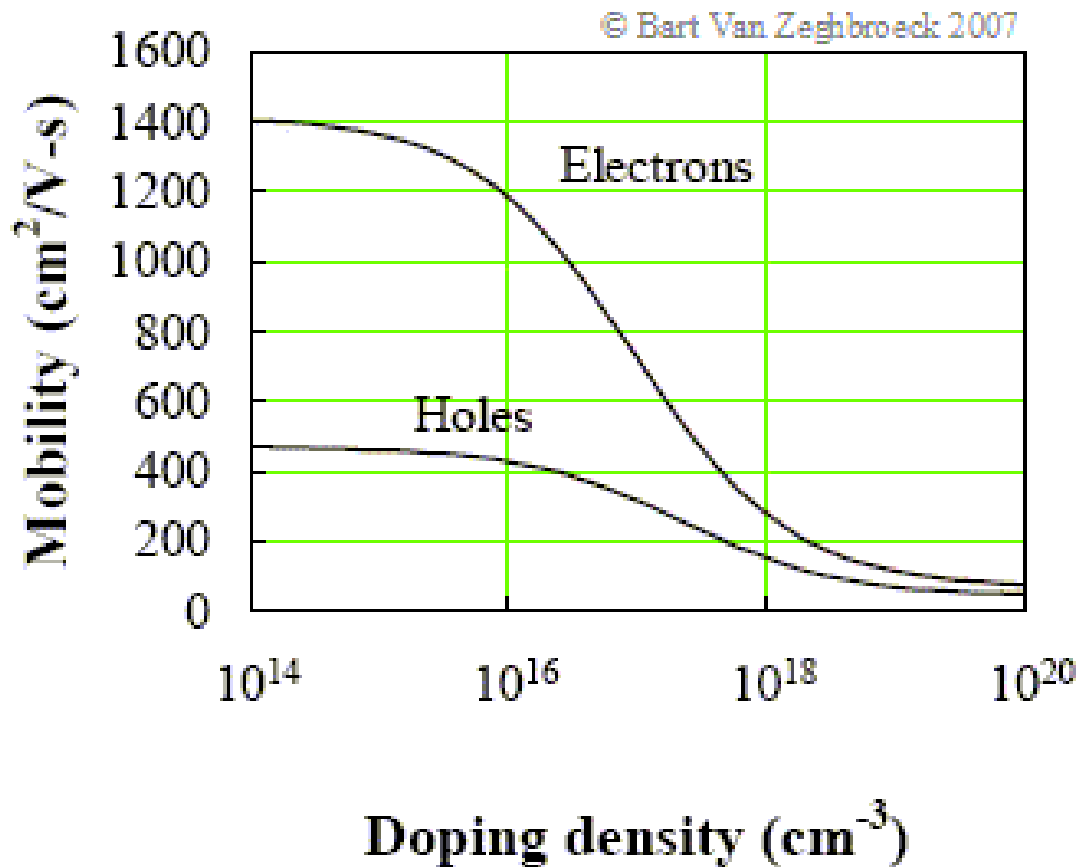

Charge carriers in semiconductors

Electron (n) & hole (p) concentration in semiconductor:

equal amount of holes & electrons in intrinsic semiconductors

$$n = p = n_i$$

$$np = n_i^2 = N_c N_v e^{\frac{-E_g}{kT}}$$

N_c and N_v are the *effective densities of states*

k is Boltzmanns constant ($1.38 \times 10^{-23} \text{ J K}^{-1}$)

Carrier concentrations in equilibrium related to the band edges:

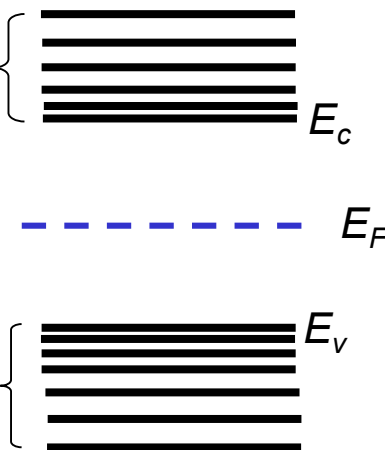
$$n = N_c e^{-\left(\frac{E_c - E_f}{kT}\right)}$$

$$p = N_v e^{-\left(\frac{E_f - E_v}{kT}\right)}$$

Fermi level: probability to find an electron at this energy level is 50%

located at midgap in intrinsic semiconductors

Doping of semiconductors (e.g. Silicon)

Phosphorus (P)

5 outer electrons vs Si's 4

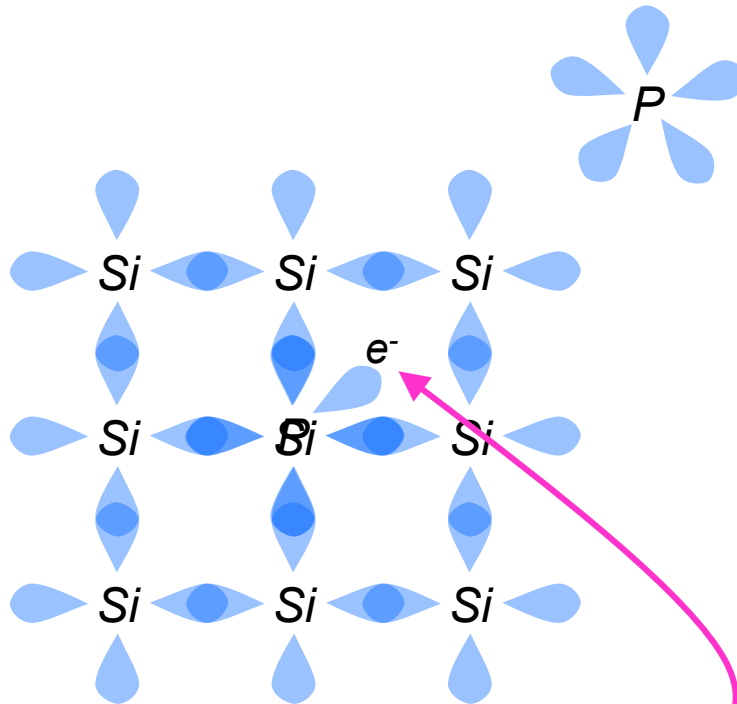

One electron per donor atom

⇒ **n-type doping**

Boron (B)

3 outer electrons vs Si's 4

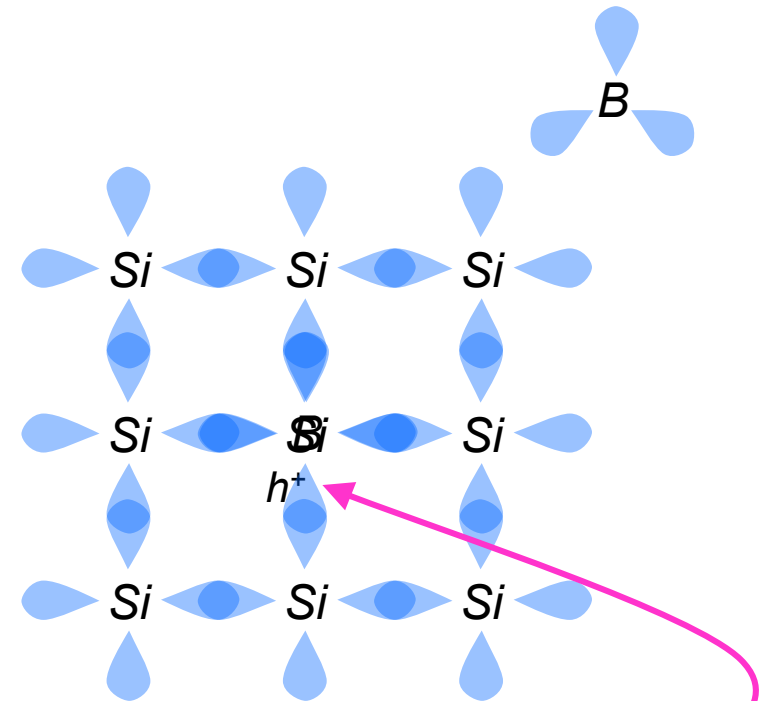

One hole per acceptor atom

⇒ **p-type doping**

Doping of Semiconductors

- Undoped (intrinsic) semiconductors have low conductivity because the concentration of free (mobile) charge carriers is very low.
- Doping with impurities can add free (mobile) electrons or holes:

Donors \Rightarrow donate electrons

n-type

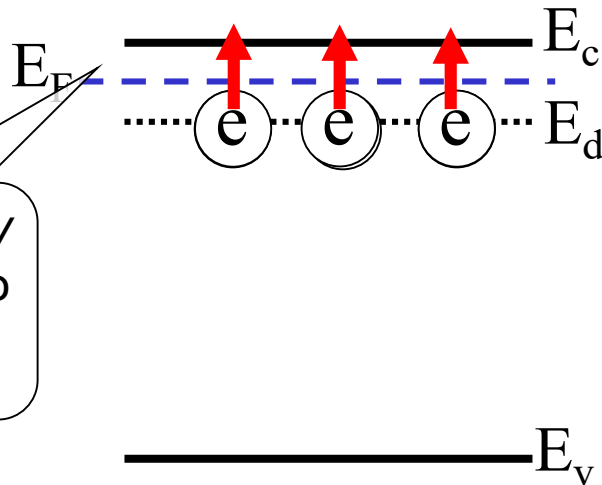

Fermi energy E_F is close to conduction band

Acceptors \Rightarrow accept electrons

p-type

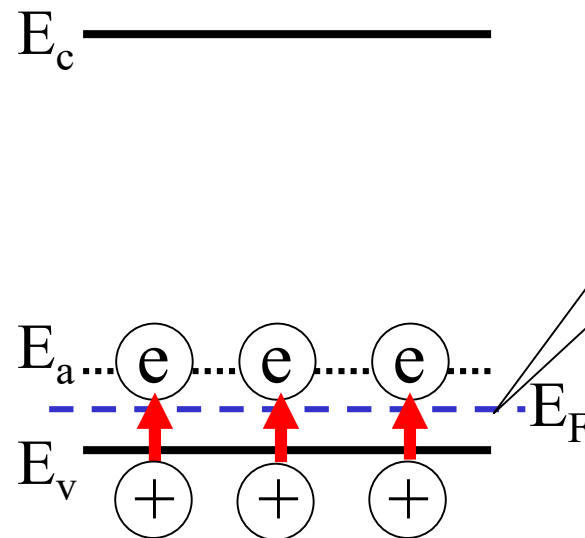

E_F is close to valence band

thermal energy ($\sim kT$) is sufficient to "activate" the carriers

The PN Junction (1)

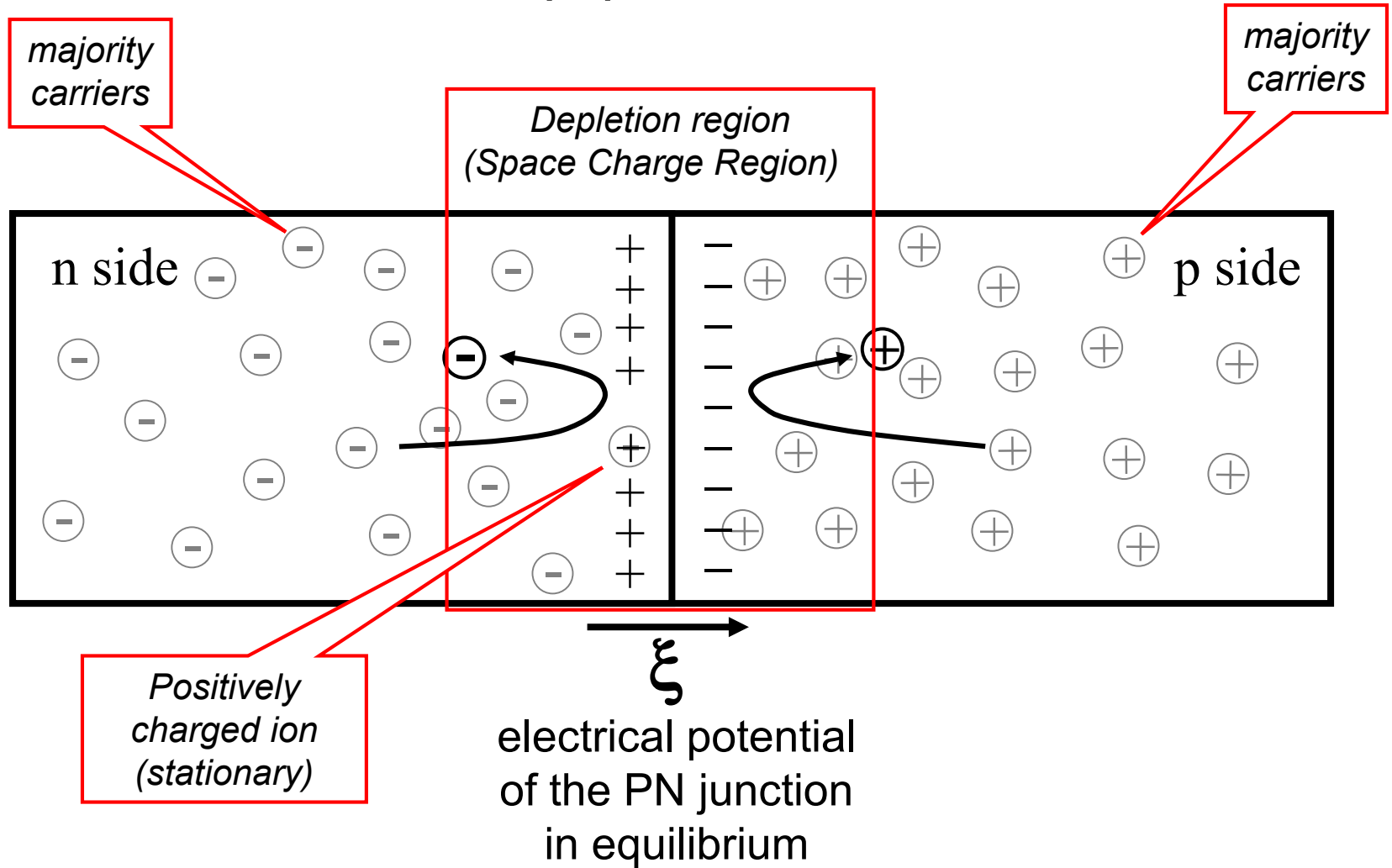

P-N junction provides charge separation

Built-in Voltage & Depletion Width

Built in voltage V_{bi}

$$qV_{bi} \approx kT \ln\left(\frac{N_a N_d}{n_i^2}\right)$$

N_a, N_d – concentration of acceptors (donors)

n_i – intrinsic carrier concentration

Depletion width W

$$W = \sqrt{\frac{2\epsilon}{q} \left(\frac{N_a + N_d}{N_a N_d}\right) V_{bi}}$$

ϵ – dielectric constant

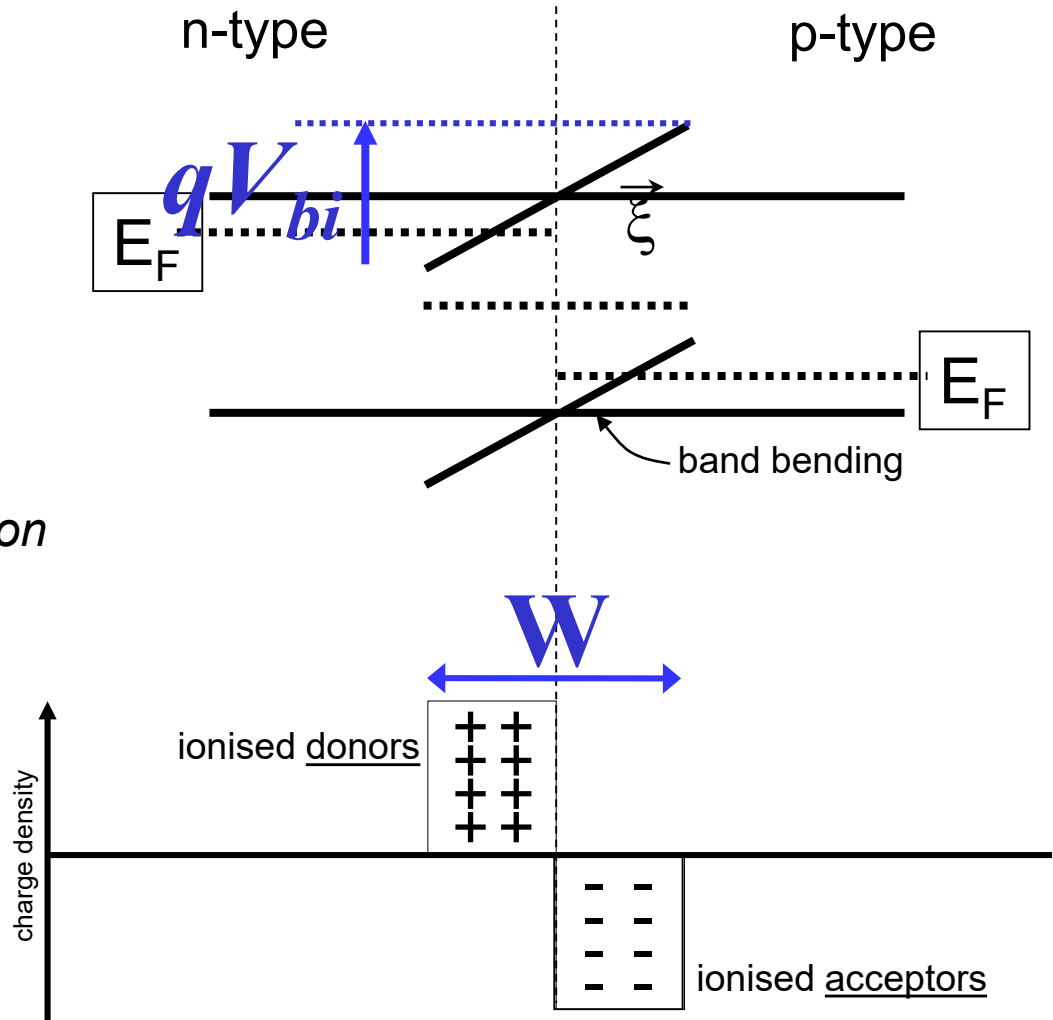

Solar cell parameters

Operation of p-n junction solar cell

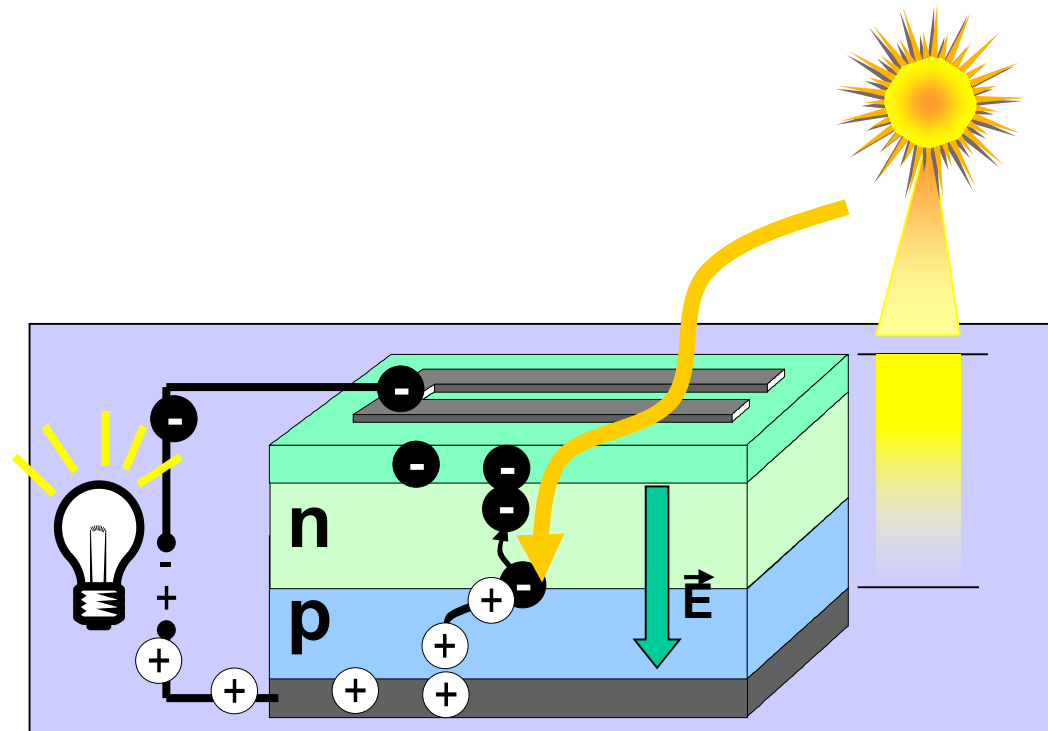

1. Light absorption
2. Generation of free mobile carriers
3. Separation of the free carriers

P-N junction under illumination

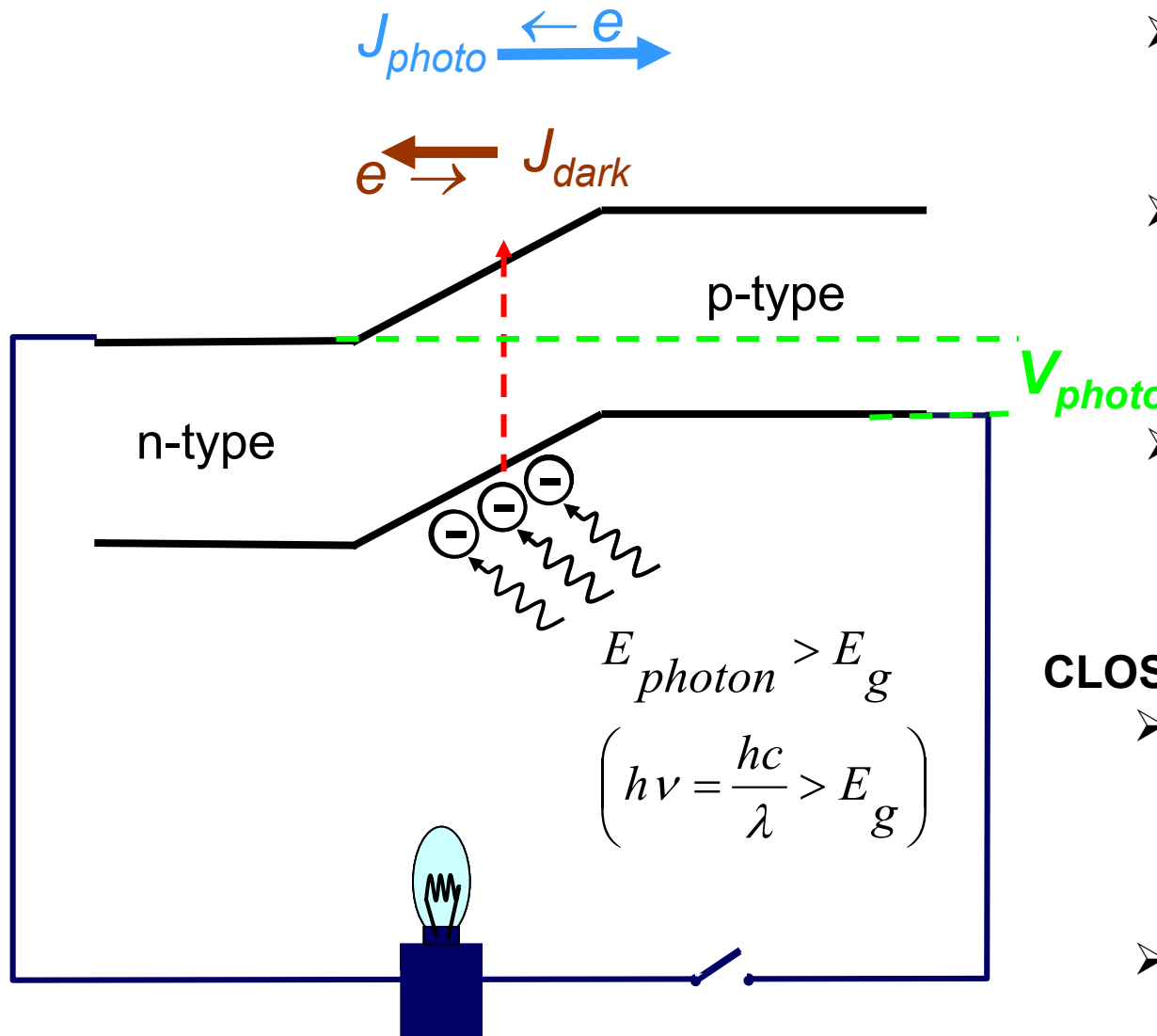

OPEN CIRCUIT:

- Opposite charges build up on the contacts
- photovoltage V_{photo} is produced (maximum is open circuit voltage V_{oc})
- Dark current (J_{dark}) equilibrates new photogenerated

CLOSED CIRCUIT:

- Charges flow via external circuit as photocurrent J_{photo}
- J_{photo} flows in the opposite direction to J_{dark}

Effect of light on I-V curve

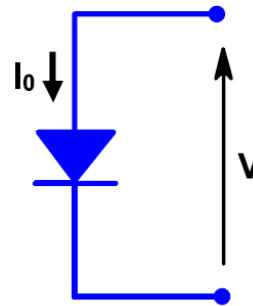
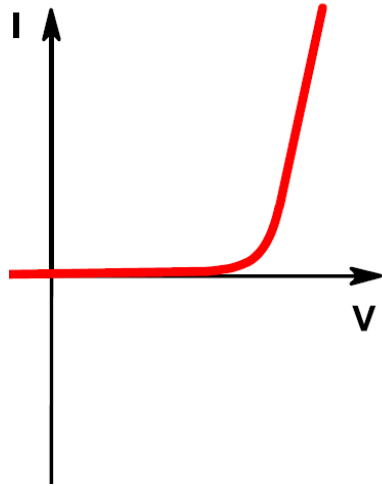

Without illumination, a solar cell acts like a diode

=> I-V curve is identical

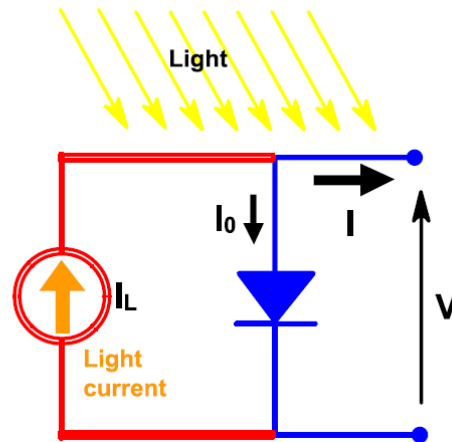
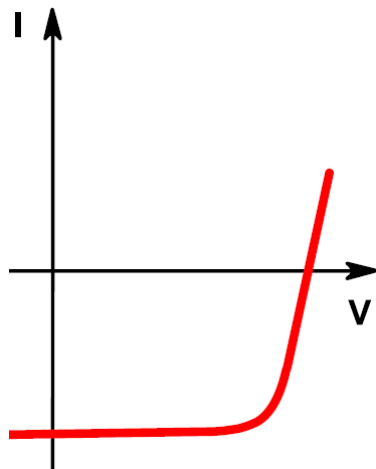

Under illumination, solar cell produces photocurrent

=> I-V curve shifts down by the value of light current

Current equation

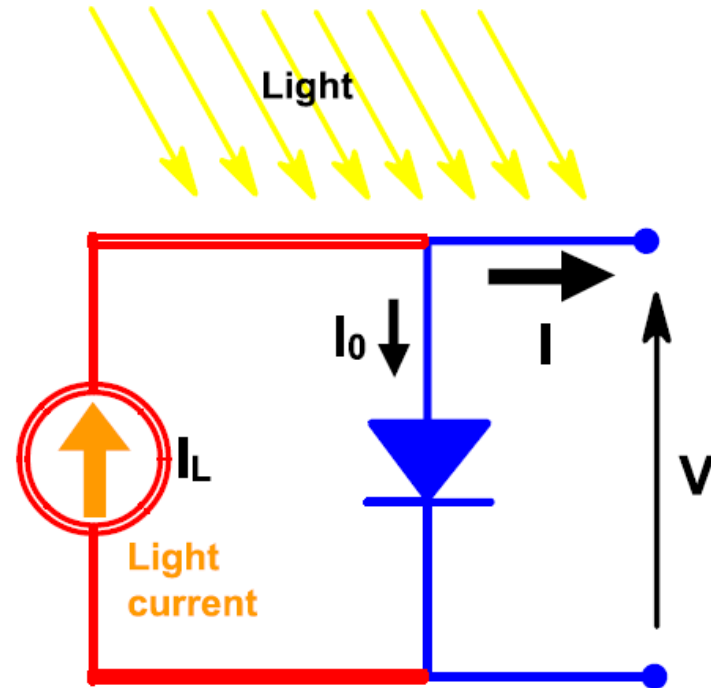
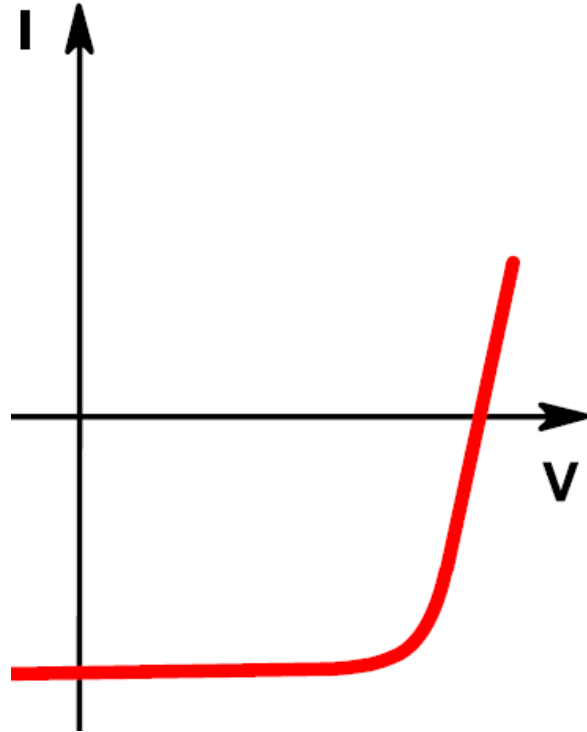

$$I = I_0 \left(\exp\left(\frac{qV}{kT}\right) - 1 \right) - I_L$$

Light-induced current (photocurrent) is proportional to the incident light intensity

Current equation (mirrored form)

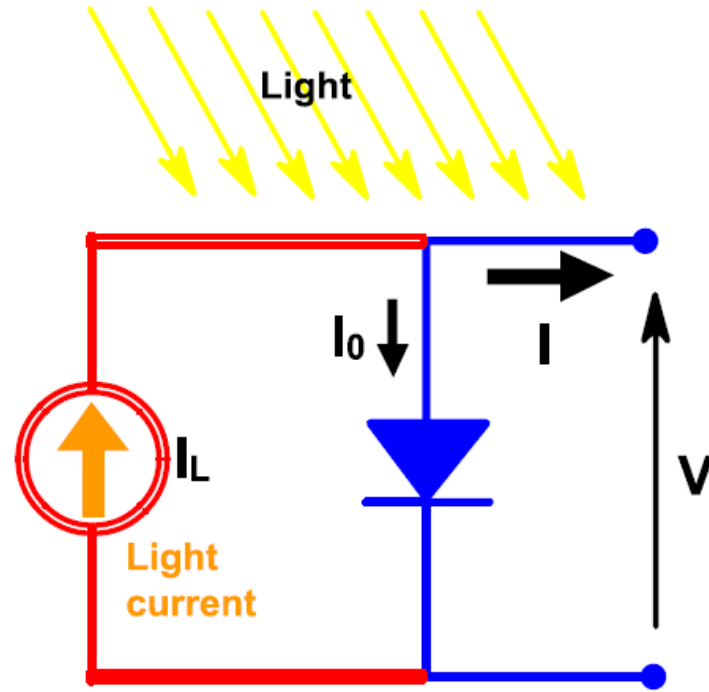
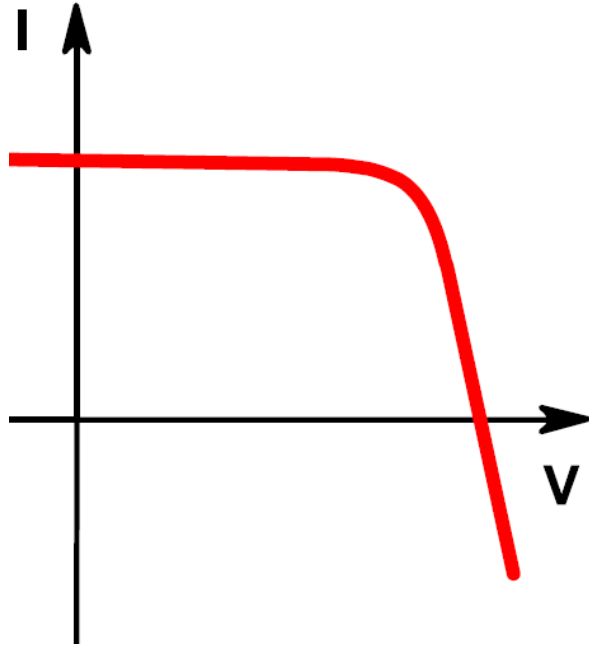

Since the cell is generating power, the convention is to invert the current axis

$$I = I_L - I_0 \left(\exp\left(\frac{qV}{kT}\right) - 1 \right)$$

I-V curve & power curve

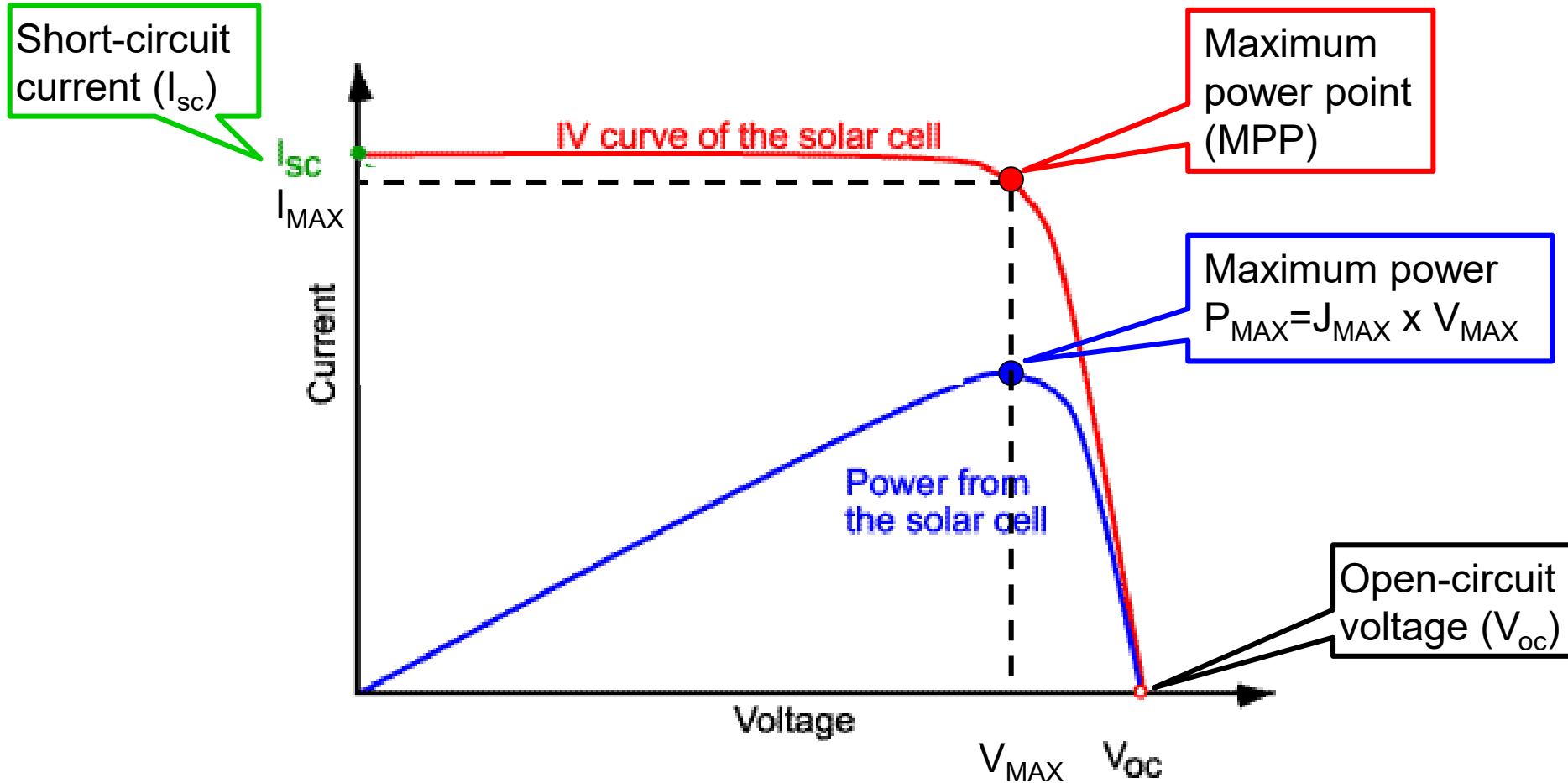

- I-V curves are measured under **standard test conditions** in order to compare various technologies: light intensity 1000 W/m^2 , light spectrum AM1.5G, and cell temperature $T=25^\circ\text{C}$

Short circuit current I_{sc}

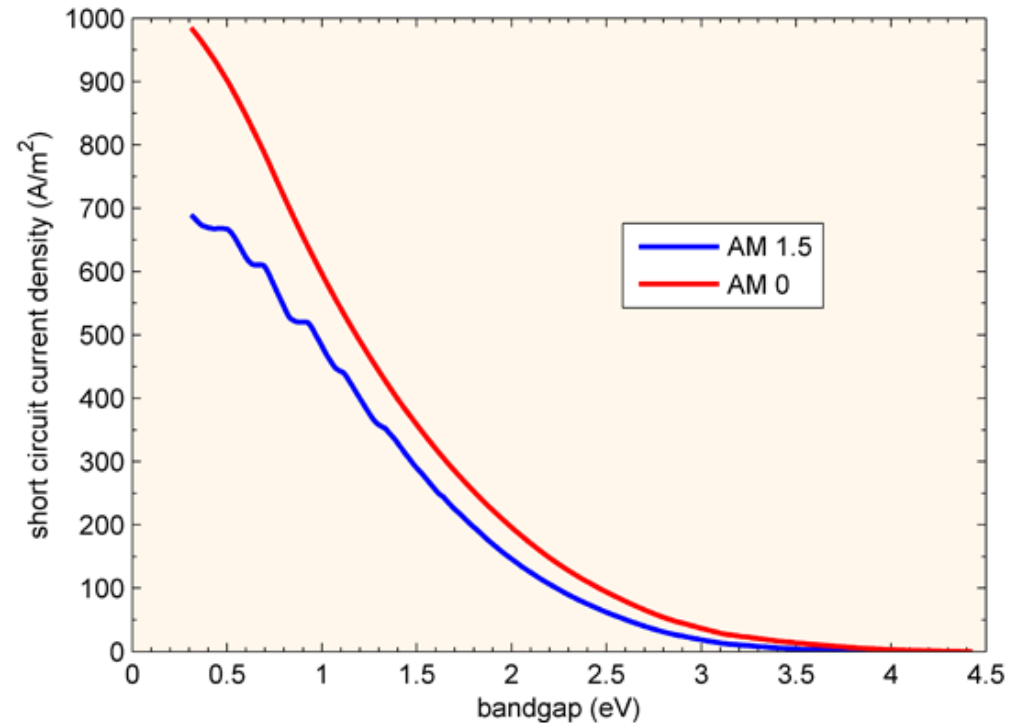
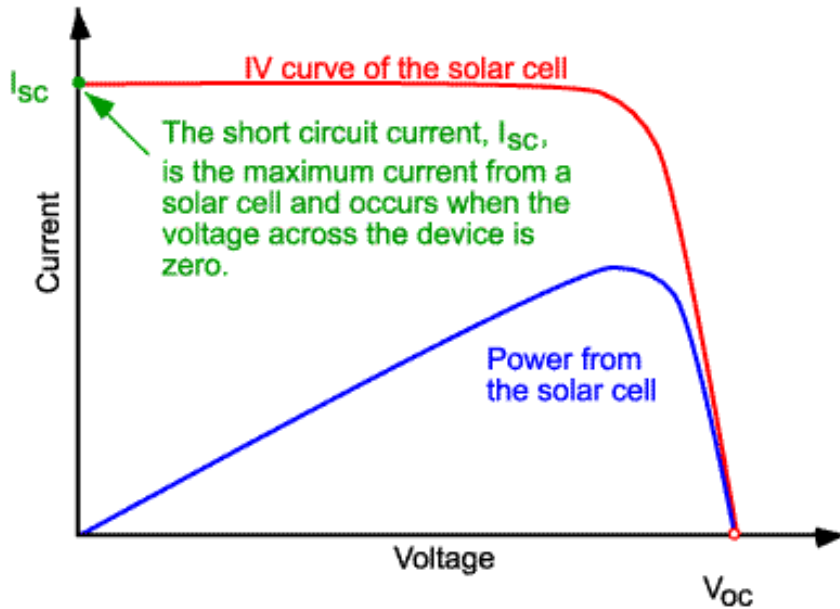

- Short circuit current I_{sc} is the current when voltage across the device is zero
- I_{sc} is essentially the light-induced current if we neglect series resistance ($I_{sc} = I_L$)
- To remove the dependence on the solar cell area, it is more common to use the **short-circuit current density** (J_{sc} in mA/cm^2) rather than absolute current

Open circuit voltage V_{oc}

START HERE
(the diode equation)

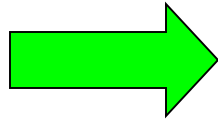

$$I = I_L - I_0 \left(\exp\left(\frac{qV}{kT}\right) - 1 \right)$$

$$\text{At } V_{oc} \ I=0 \quad \Rightarrow \quad 0 = I_L - I_0 \left(\exp\left(\frac{qV_{oc}}{kT}\right) - 1 \right)$$

$$\frac{I_L}{I_0} + 1 = \exp\left(\frac{qV_{oc}}{kT}\right)$$

$$V_{oc} = \frac{kT}{q} \ln\left(\frac{I_L}{I_0} + 1\right)$$

$$\begin{aligned} I_L &\sim \text{A} & I_0 &\sim 10^{-9} \text{A} \\ \Rightarrow I_L &\gg I_0 \\ \Rightarrow I_L / I_0 &\gg 1 \end{aligned}$$

$$V_{oc} \approx \frac{kT}{q} \ln\left(\frac{I_L}{I_0}\right)$$

Fill Factor FF

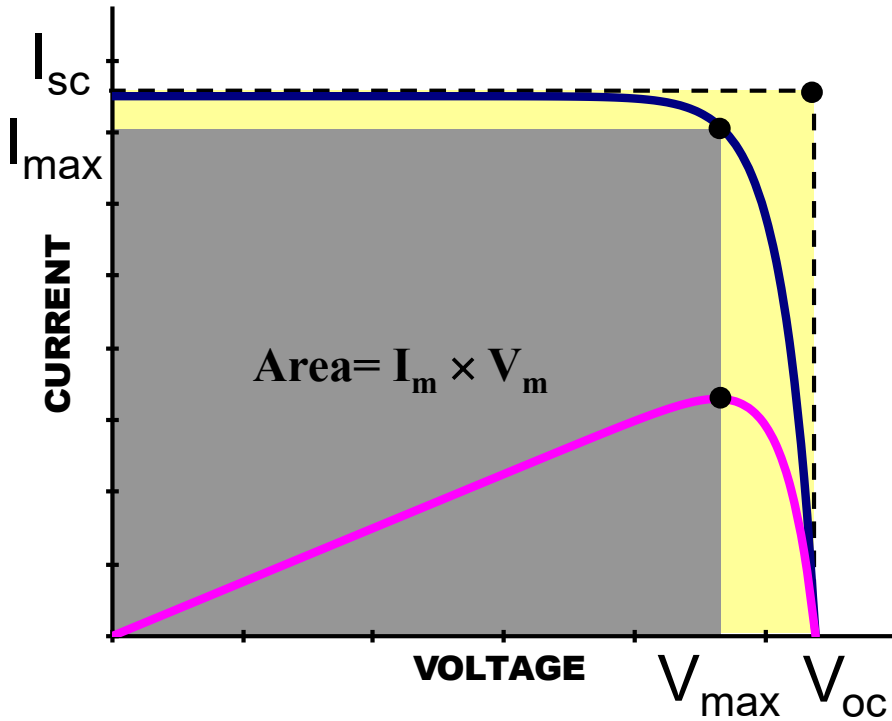

Maximum theoretical power

$$P_m = I_{sc} V_{oc}$$

Maximum power point (MPP)

$$P_{MPP} = I_{max} V_{max}$$

$$FF = \frac{\text{area } I_{max} \times V_{max}}{\text{area } I_{sc} \times V_{oc}}$$

Effect of illumination

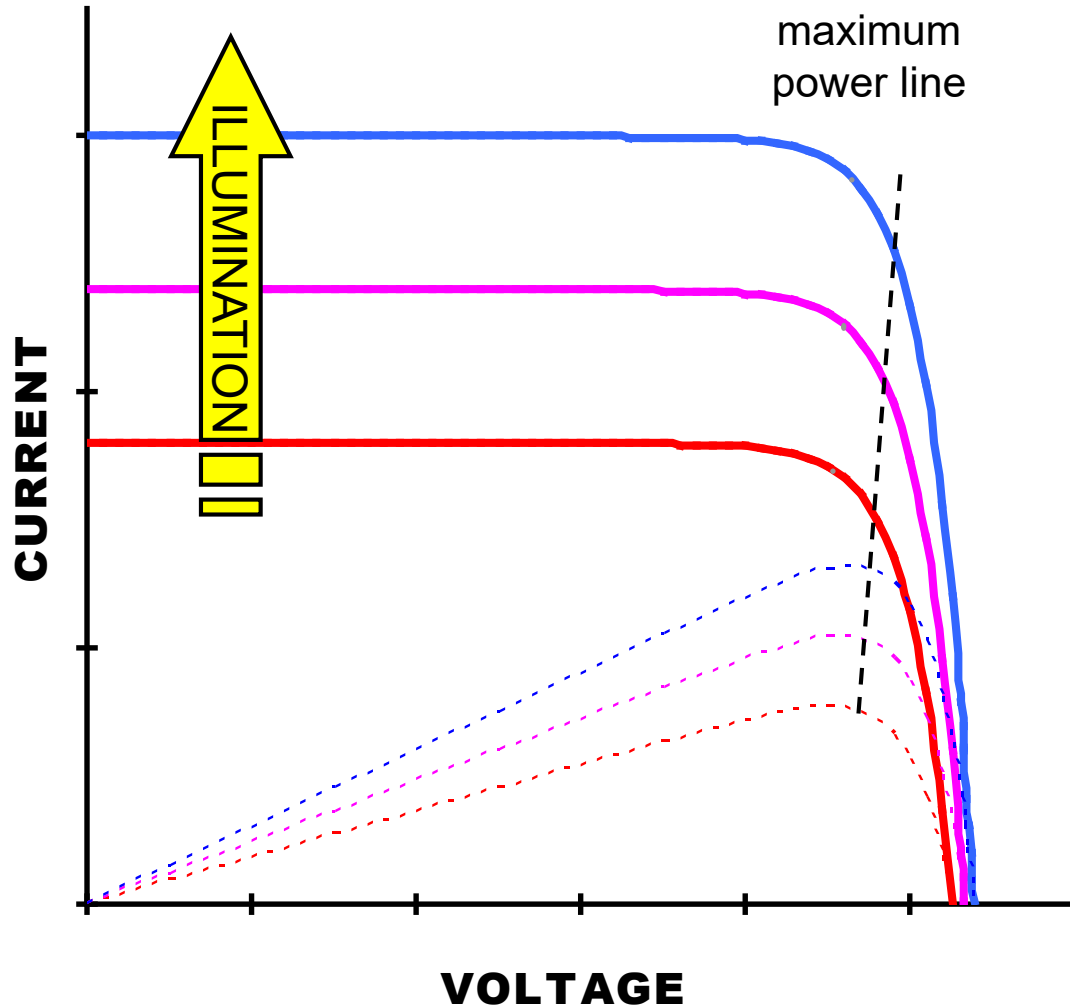

Light intensity increases:

⇒ Jsc increases proportionally

⇒ Voc goes up

⇒ overall η increases (used in concentrated PV)

$$V_{oc} \approx \frac{kT}{q} \ln\left(\frac{I_L}{I_0}\right)$$

Effect of temperature

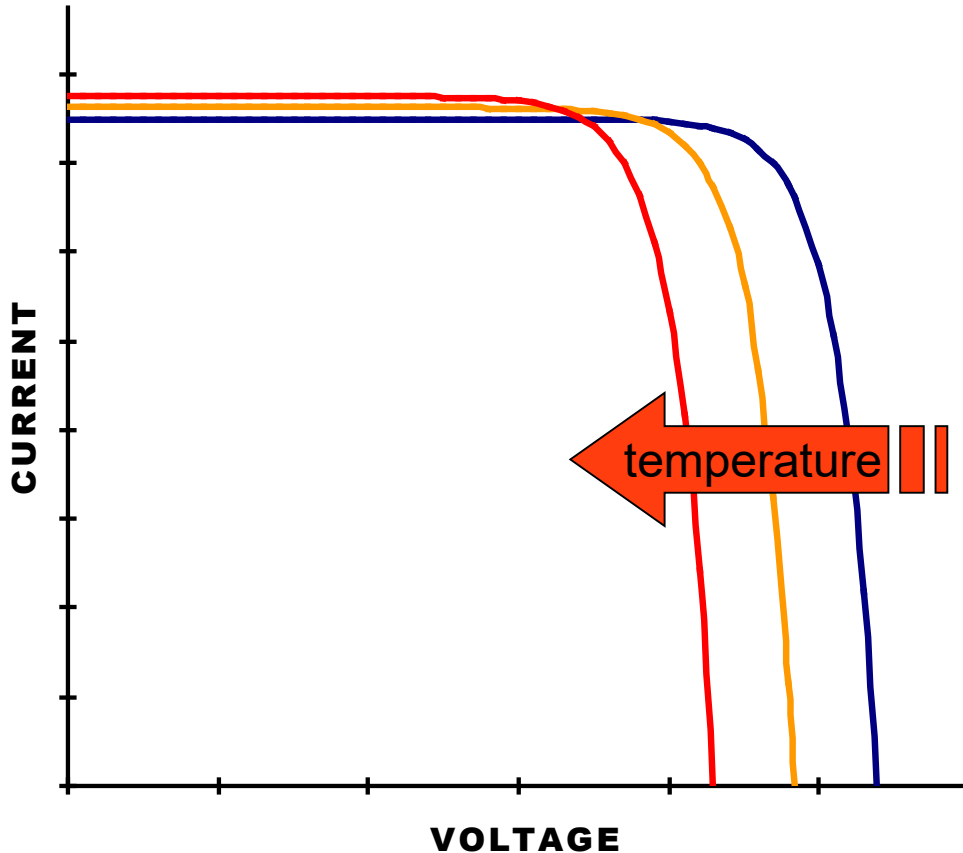

Temperature increases:

⇒ band gap E_g is reduced

⇒ the current density goes up

⇒ but the voltage goes down

⇒ overall η decreases.

For Si cell: $\frac{dJ_{sc}}{dT} \approx 0.1 \text{ Am}^{-2} \text{ K}^{-1}$

$$\frac{dV_{oc}}{dT} \approx -2.2 \text{ mVK}^{-1}$$

$$\frac{d\eta}{dT} \approx -0.5\% \text{ K}^{-1}$$

Solar cell characteristics

- **Short-circuit current density J_{SC} :**
 - proportional to irradiation
 - Typical 30-40 mA cm⁻²
 - Increases by 0.07% per Kelvin
- **Open-circuit voltage V_{OC} :**
 - This is the voltage along the internal diode
 - Typical values 0.6...0.7 V depending on semiconductor
 - decreases by 0.4% per Kelvin
- **Power (MPP, Maximum Power Point)**
 - Power decreases by 0.4% per Kelvin
- The nominal power of a cell is measured at standard test conditions (STC):
 $G_0 = 1000 \text{ W/m}^2$, $T_{\text{cell}} = 25^\circ\text{C}$, AM 1.5G spectrum

Equivalent circuit of a real solar cell

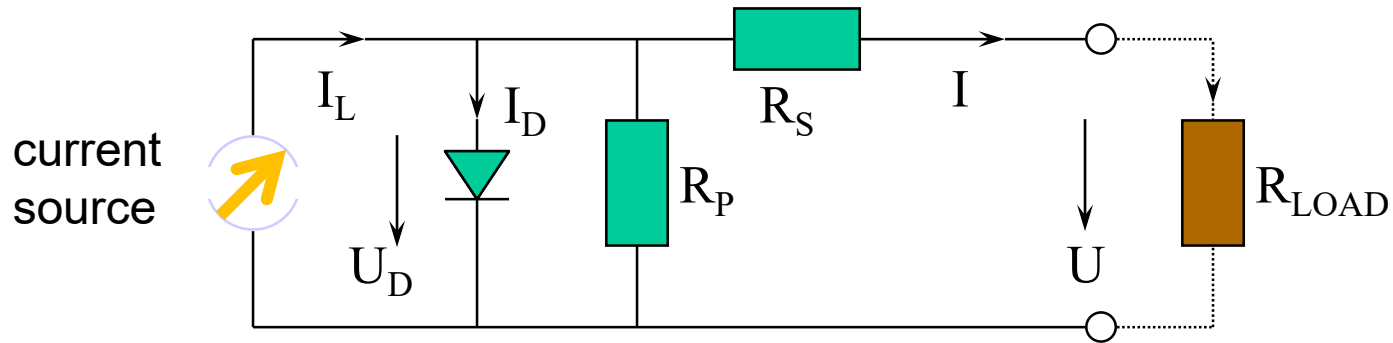

I_L : Light-induced current of the solar-cell

I_D / U_D : dark current and voltage of the internal p-n diode

R_P : parallel (shunt) resistor due to inhomogeneity of the surface and current loss at the solar-cell edges

R_S : serial resistor due to resistance of the bulk and contacts

R_{LOAD} : load resistance

Full current equation

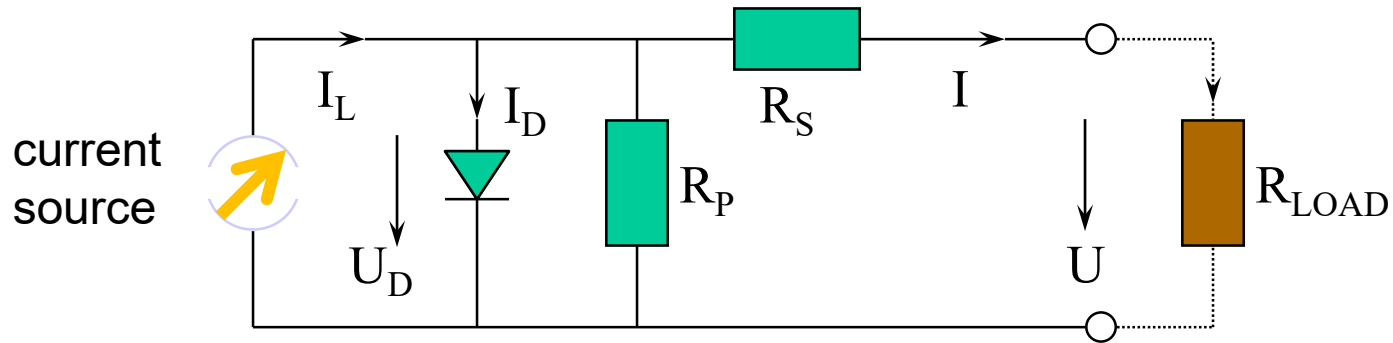

$$I = I_L - I_0 \left\{ \exp\left(\frac{q(V + IR_s)}{nkT}\right) - 1 \right\} - \frac{V + IR_s}{R_p}$$

diode ideality factor

$$n = 1 \dots 2$$

Effect of series resistance R_s

$$I = I_L - I_0 \left\{ \exp\left(\frac{q(V + IR_s)}{nkT}\right) - 1 \right\} - \frac{V + IR_s}{R_p}$$

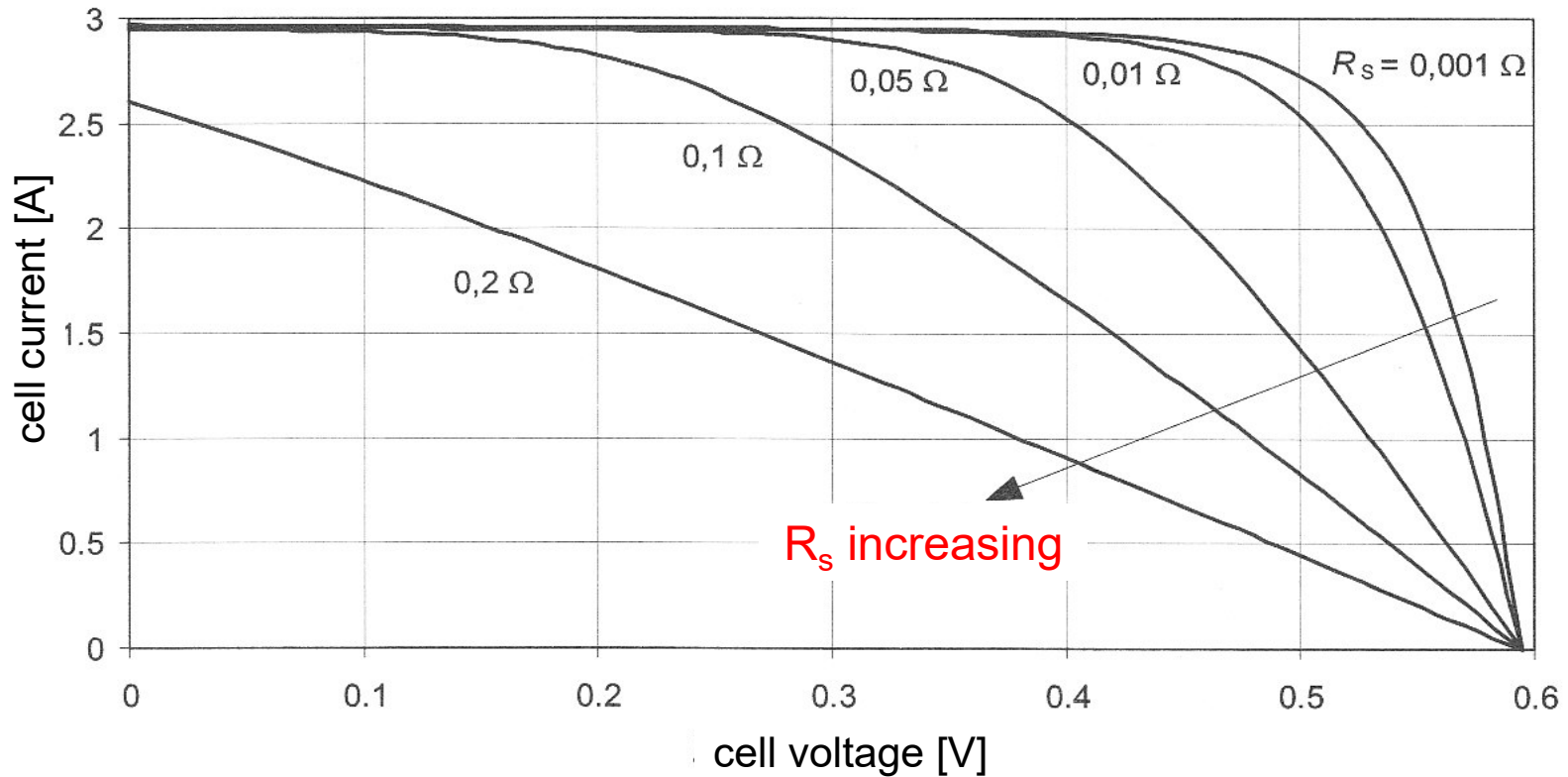

Effect of parallel resistance R_p

$$I = I_L - I_0 \left\{ \exp\left(\frac{q(V + IR_s)}{nkT}\right) - 1 \right\} - \frac{V + IR_s}{R_p}$$

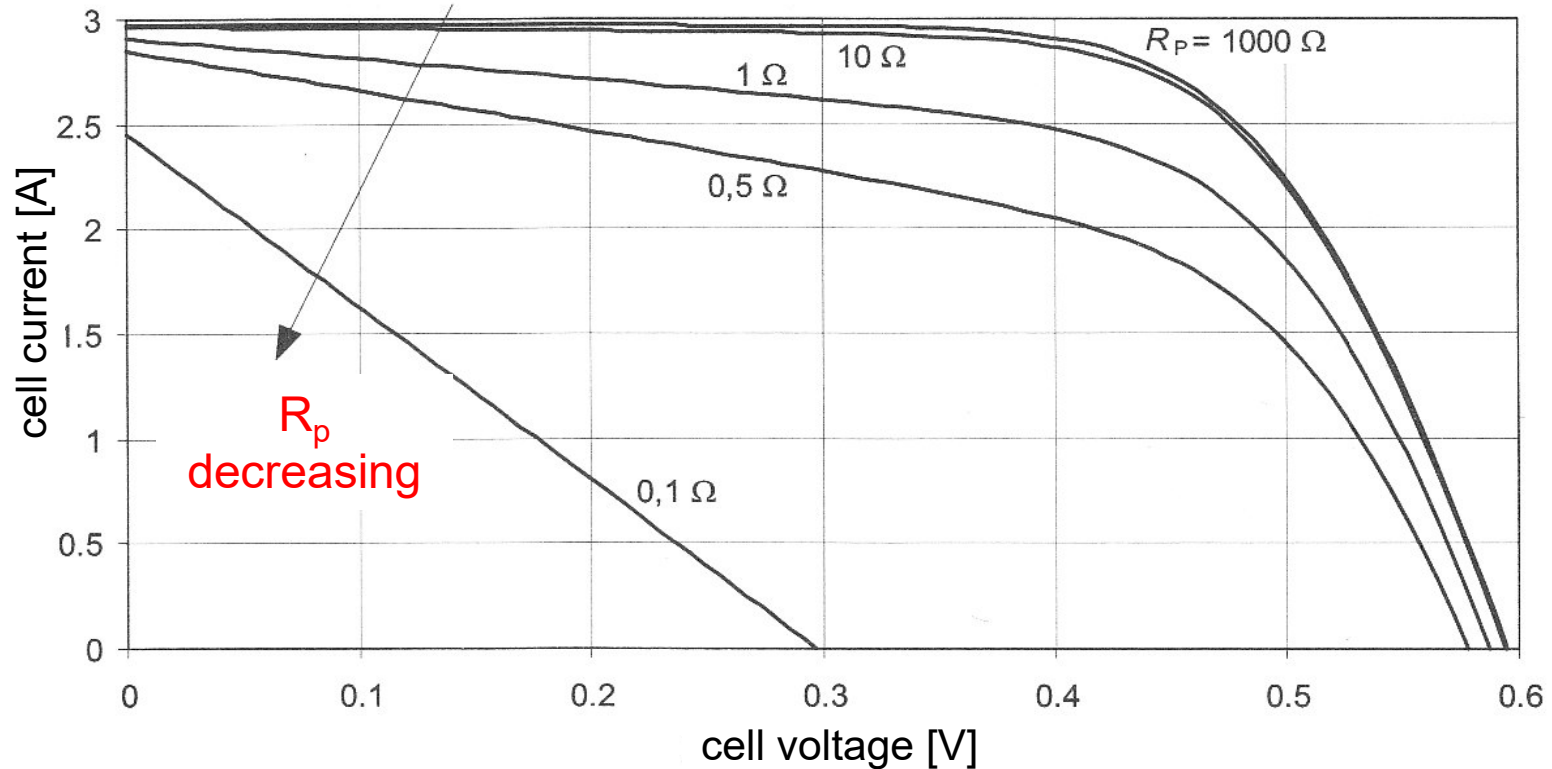

Solar cell efficiency

Efficiency: the ratio of the generated power to the power of incident light

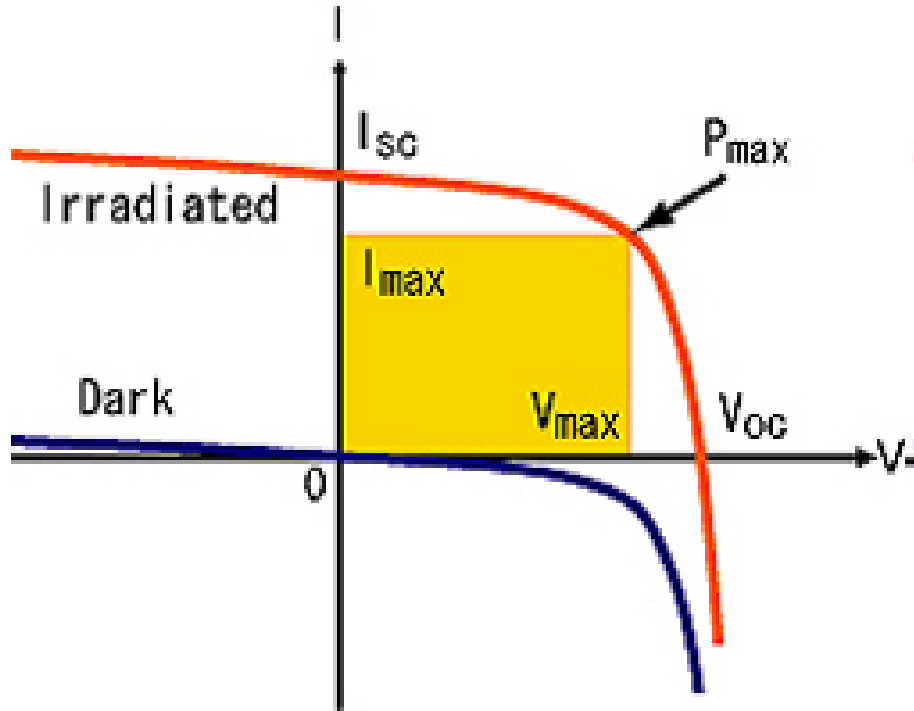

$$\eta = \frac{P_{\text{electrical}}}{P_{\text{light}}} = \frac{V_{\text{MAX}} \times I_{\text{MAX}}}{P_{\text{IN}}}$$

Standard conditions:

Light intensity $P_{\text{IN}} = 1000 \text{ W/m}^2$
 AM1.5G spectrum
 Temperature 25°C

$$FF = \frac{I_m V_m}{I_{sc} V_{oc}} \Rightarrow I_{\text{max}} V_{\text{max}} = I_{sc} V_{oc} FF \Rightarrow \eta = \frac{I_{sc} V_{oc} FF}{P_{in}}$$

Shockley-Queisser limit

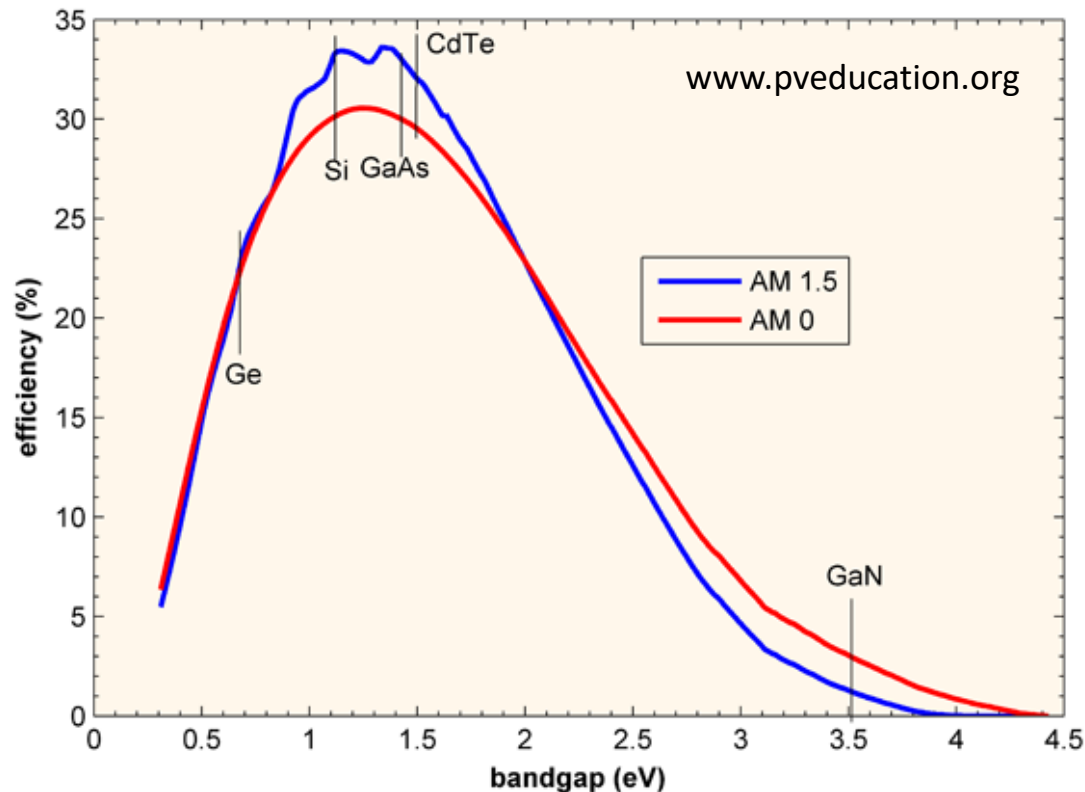

- Maximum efficiency of single-junction solar cell is **33.7%**
- Higher efficiencies are possible for **multi-junction** solar cells

W. Shockley and H.J. Queisser, "Detailed Balance Limit of Efficiency of p-n Junction Solar Cells", J. Appl. Phys. 1961

Main losses

MAIN LOSSES

1. Reflection
2. Incomplete absorption
3. Shading
4. Parasitic resistance
 - a. series resistance
 - b. shunt resistance
5. Non radiative recombination
6. Thermalisation

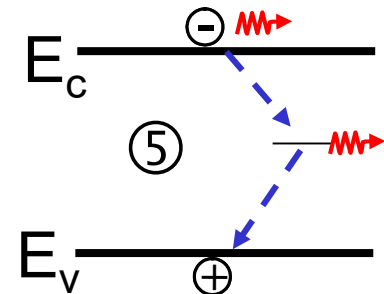
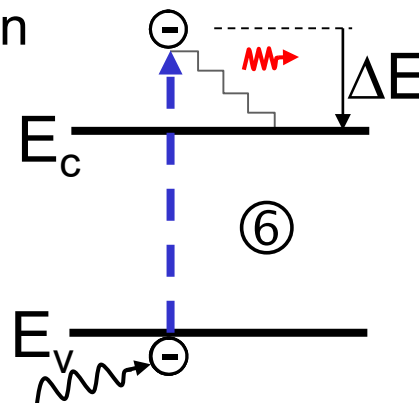
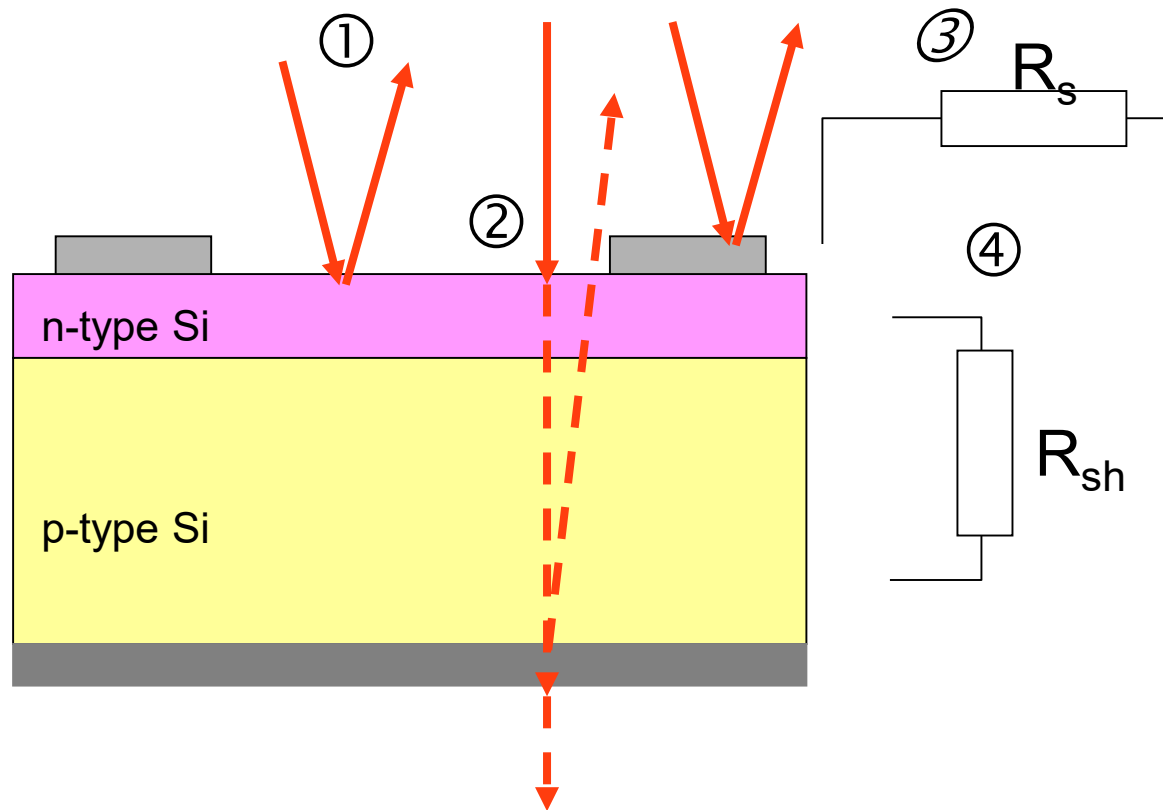

Efficiency losses

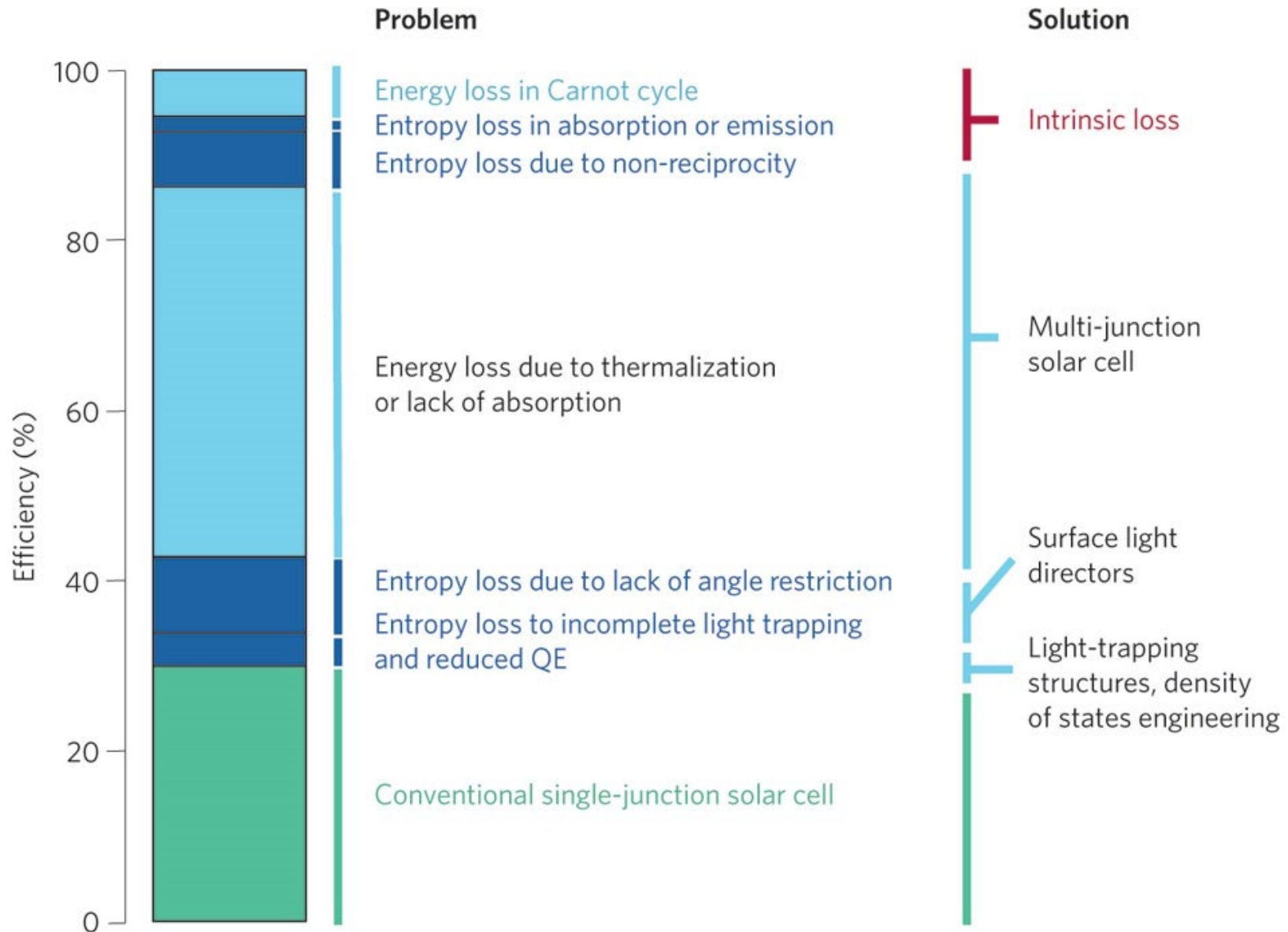

Polman and Atwater, Nature 2012

Quantum efficiency

$$QE = \frac{\text{electrons}}{\text{photons}} \times 100\%$$

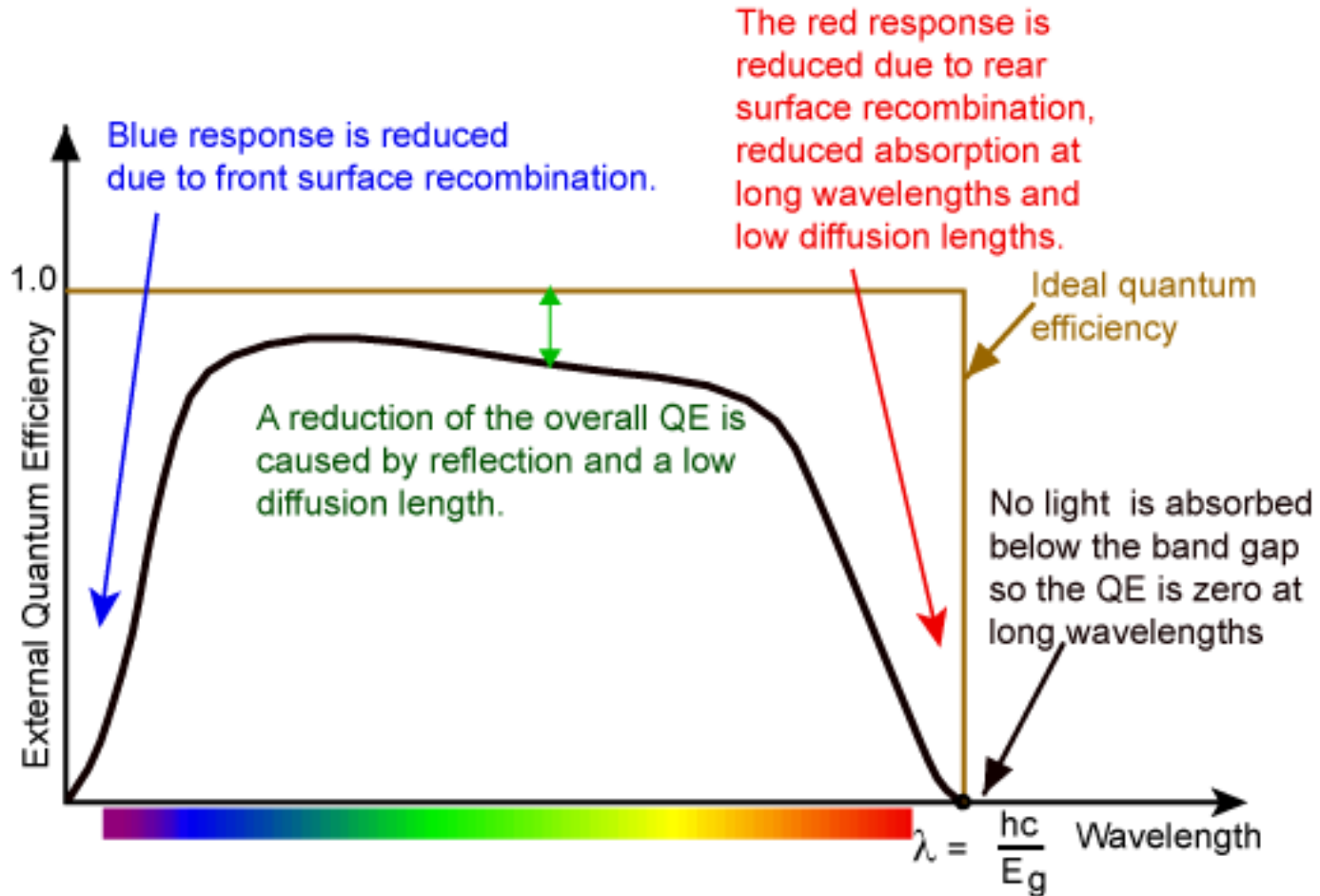

Quantum efficiency for different cells

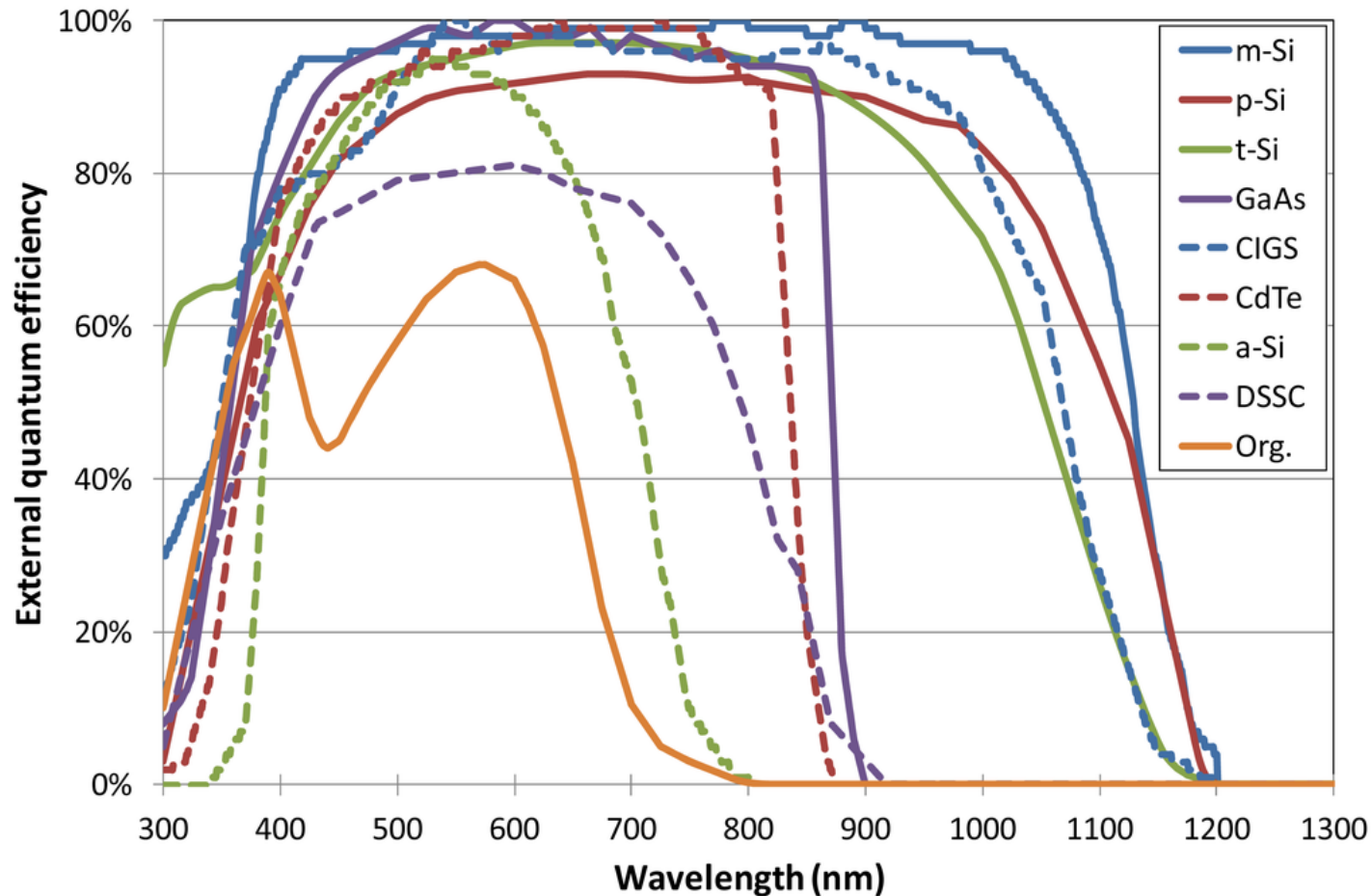

Image from: Energies 2014, 7(3), 1500-1516; doi:10.3390/en7031500