

Les composites polymères : MSE340-2023

Introduction

pierre-etienne.bourban@epfl.ch

veronique.michaud@epfl.ch

Institut des matériaux (IMX)
Ecole Polytechnique Fédérale de Lausanne (EPFL),
CH-1015 Lausanne

www.....composites.....

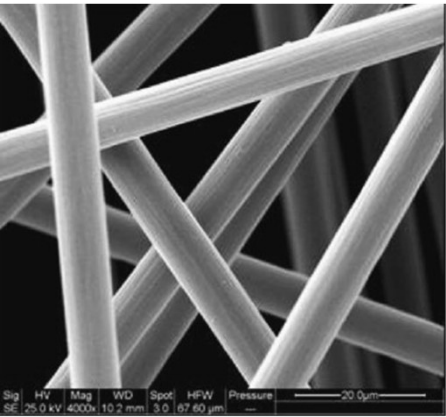

www.reinforcedplastics.com

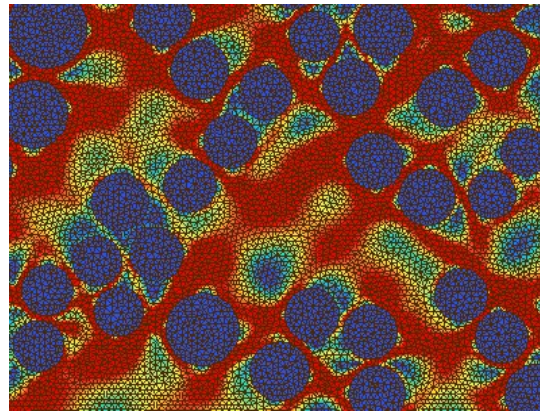

www.onera.fr

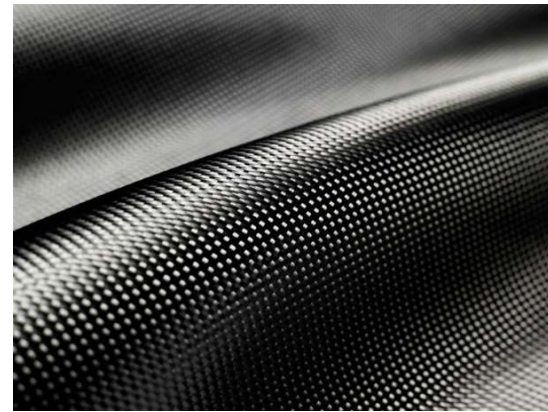

blog.motorlegend.com

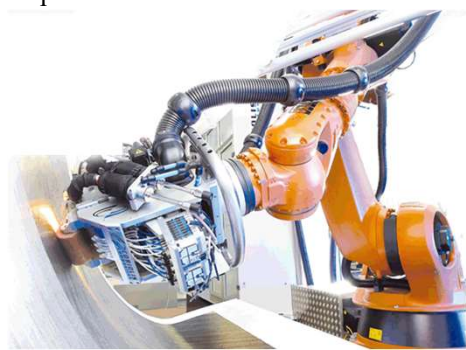

www.coriolis-composites.com



Boeing



BMW i8 automobile.challenges



www.decision.ch



Samsonite zedomax.com



www.evolo.us

Menu du jour

- Composites et composites ?
- Quels sont leurs domaines d'applications ?
- Pourquoi des composites ?
- Les catégories de composites organiques
- Propriétés mécaniques spécifiques
- Mise en œuvre
- Recherche et développements actuels

Matériaux composites

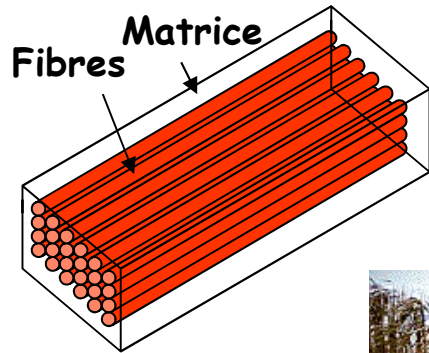

bois

torchis

tissus vivants

carapaces d'insectes

béton armé

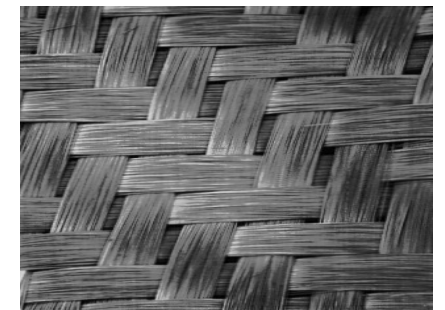
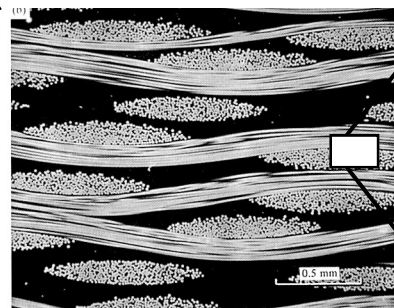
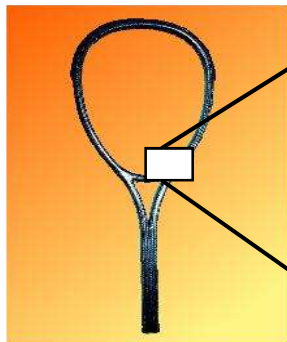
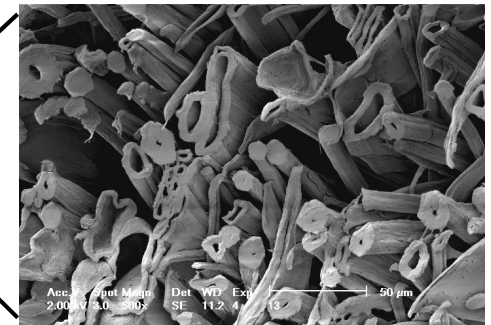
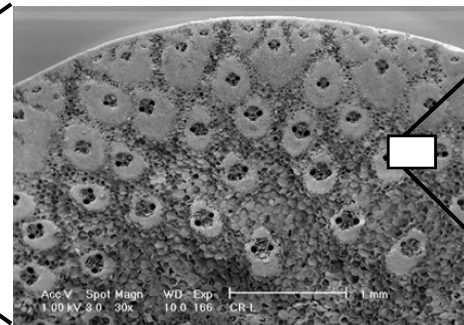

Les composites égyptiens

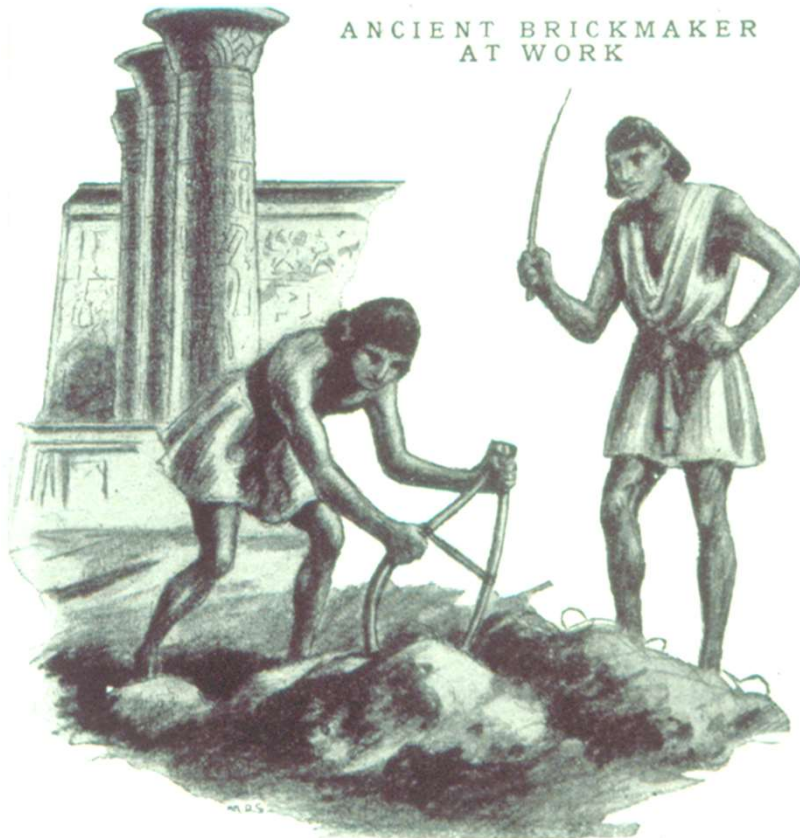

This Egyptian slave of the days of Rameses the Great is shown mixing the Nile clay with chopped straw to make the building material for some great temple. He is using a primitive type of hoe, while a slave-driver stands over him with a whip

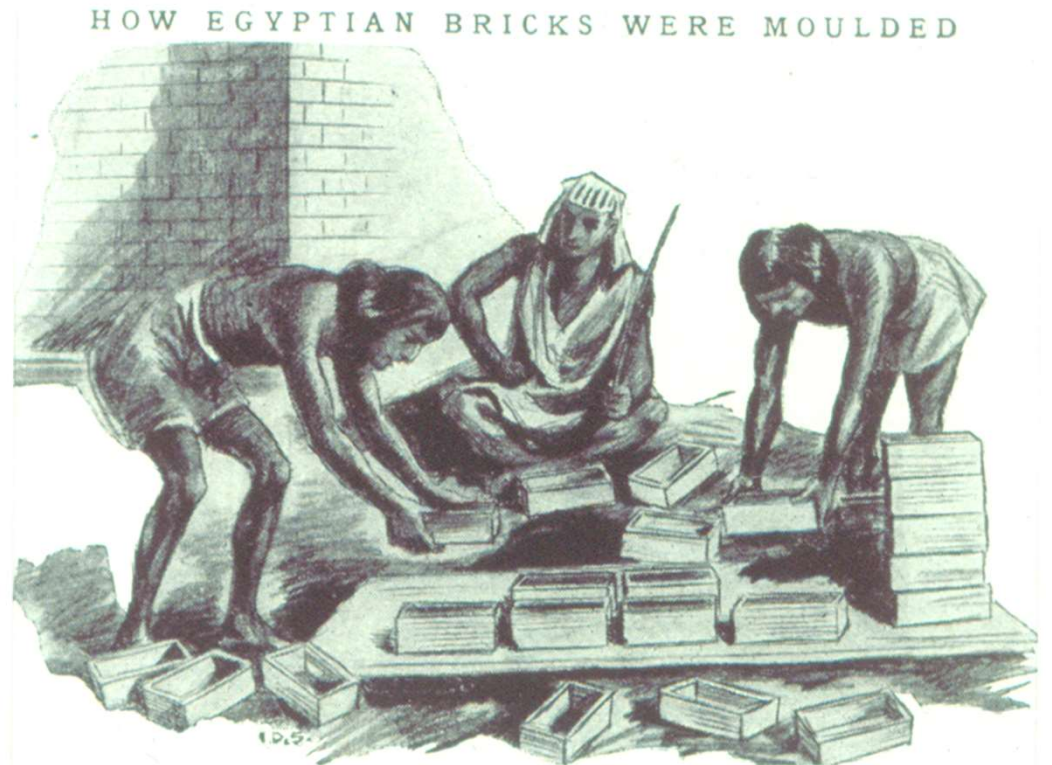

The mixture of clay and chopped straw was packed by hand into individual moulds, and then piled up in the sun until partly dry. Then the mould was taken off and the drying completed. Egyptian bricks were rarely baked with fire, so that most of the ancient brick buildings in the Nile valley have crumbled.

Evolution des matériaux

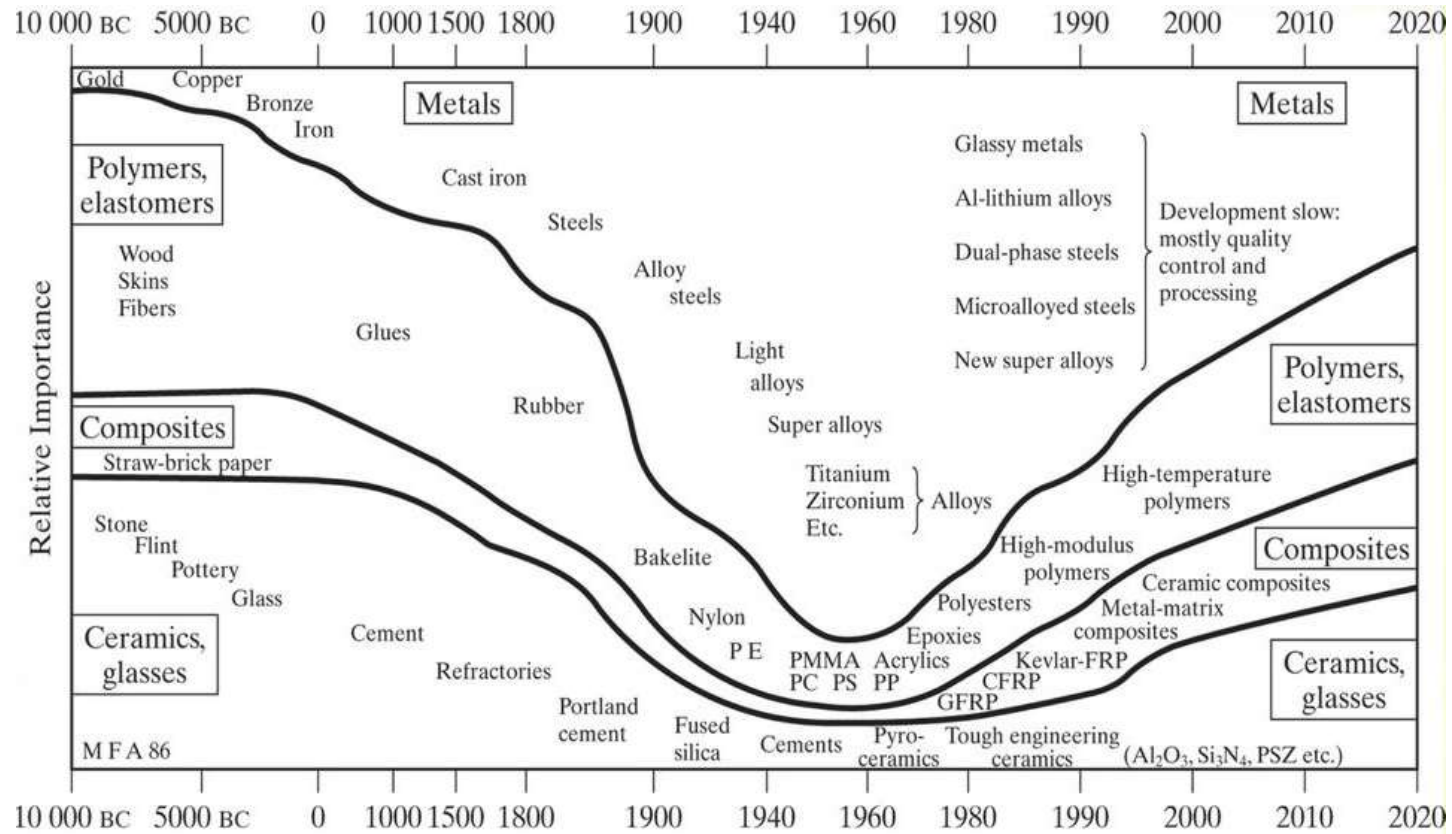

Ashby

Les polymères et leurs composites

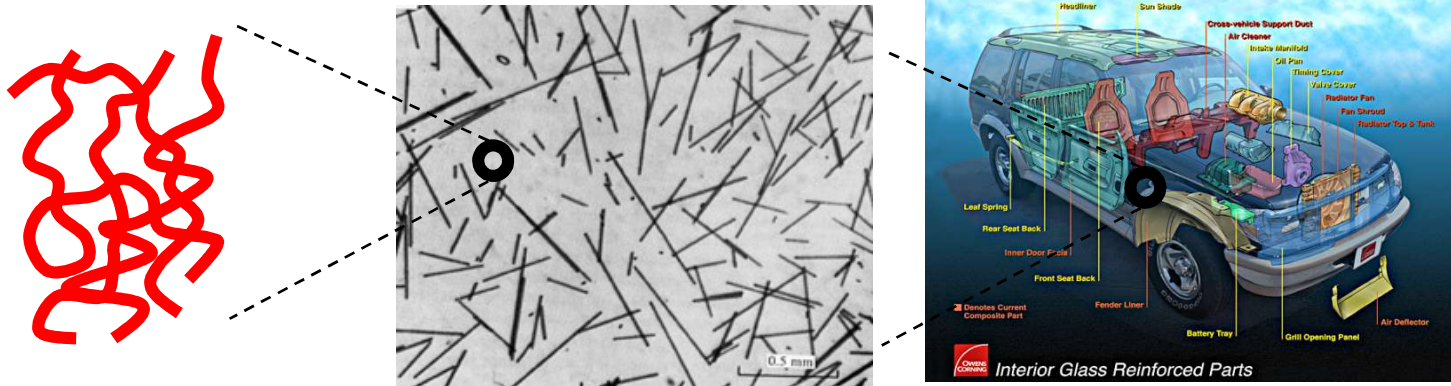

Applications des composites



Sports et loisirs

Raquette de tennis, skis, clubs de golf, perches pour le saut, arcs et flèches, casques, cannes à pêche



Mécanique

Engrenages, boîtiers, corps de vérin, bras de robots, roues inertielles, éléments de métiers à tisser, tuyauterie, bouteilles sous pression, tubes de forage, pneus.....



Construction civile

Piscines, panneaux de façades, profilés, mobilier, coffrages, éléments de ponts...



Electricité, électronique

Isolants, supports de circuits imprimés, capots, antennes, radômes, chemins de cable, éoliennes....



Applications pour le transport

Coques de bateaux, hovercrafts, voilier de compétition, mats,...

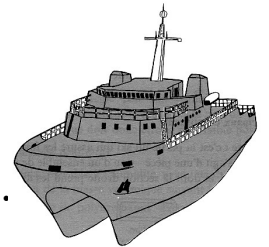

Transport maritime

Avions de tourisme et planeurs 'tout composite
Pièces d'avions: bords d'attaque, volets, dérives
Planchers, sièges, pales d'hélicoptère...

Transport aérien

Transport routier

Pièces de carrosseries, pare-chocs, calandres,
ressorts de suspension, poutres de chassis, cart
sièges, citernes, caravanes, camions isothermes,

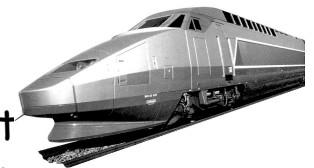

Transport ferroviaire

Carrosserie de locomotives, wagon, sièges portes, gaines de ventilation...

Transport spatial

Réservoirs, tuyères, corps de propulseurs

Transport filaire

Cabines de téléphériques

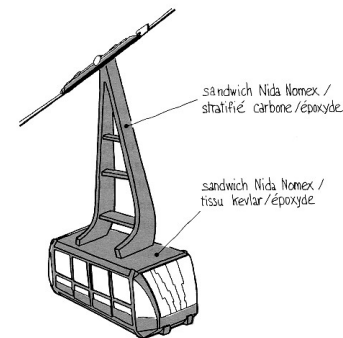

Transport aérien

A380 Composites major new applications

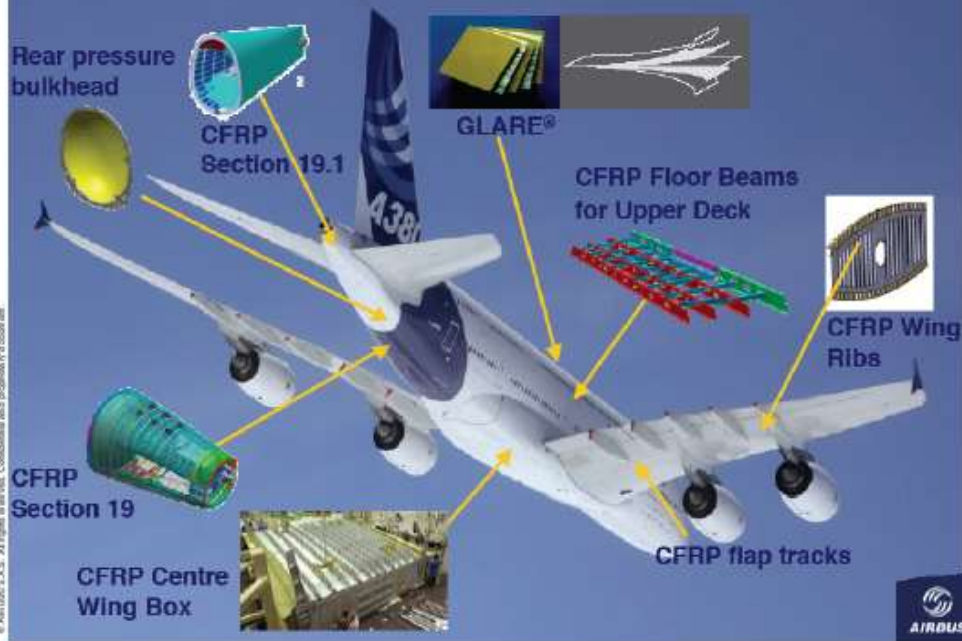

787 Materials Overview

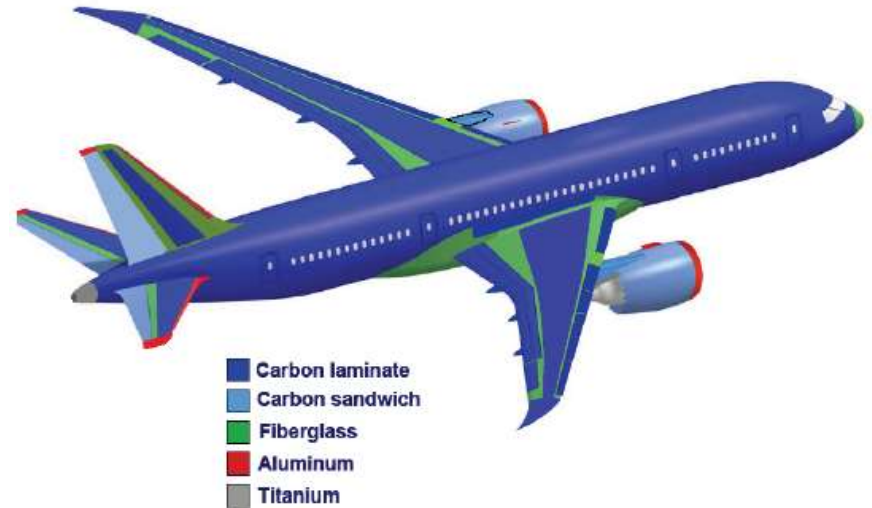

© 2011 Boeing Company. All rights reserved.



Energie



www.rhoneole.ch

Wind Turbine Materials Usage

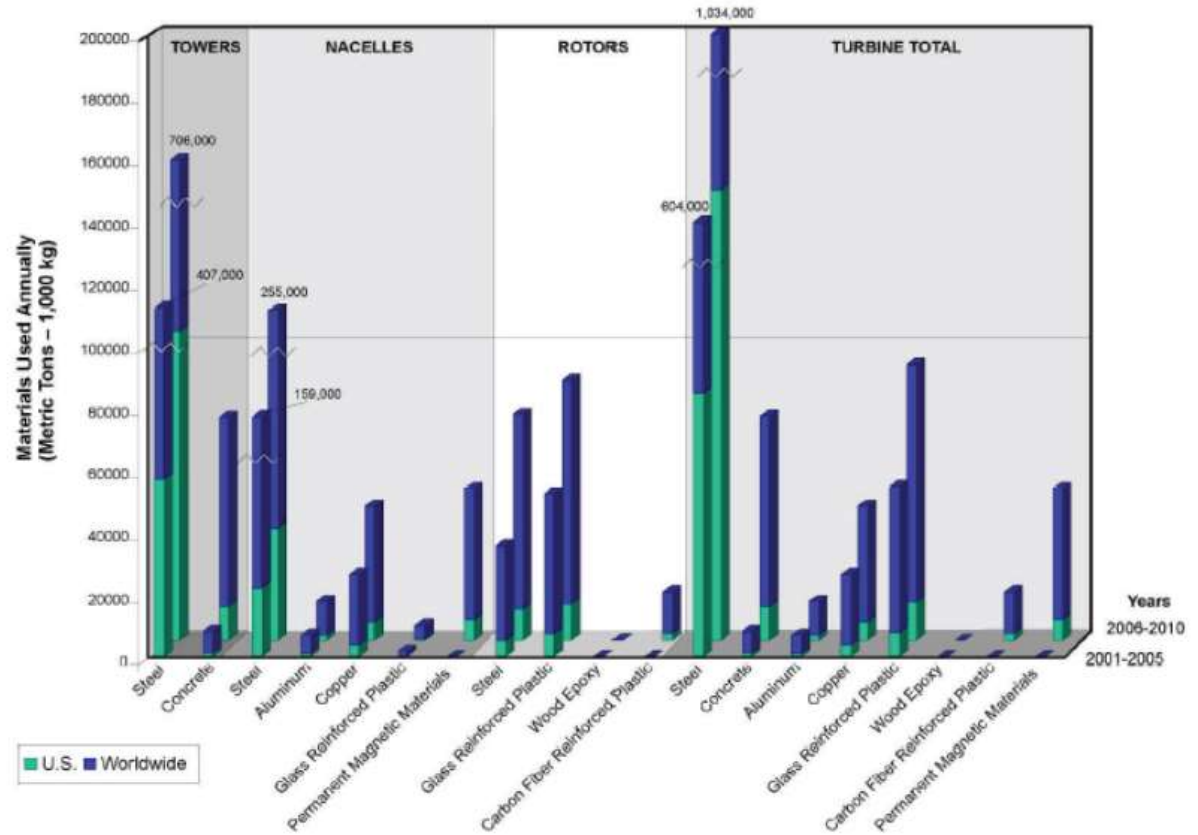

Transport automobile

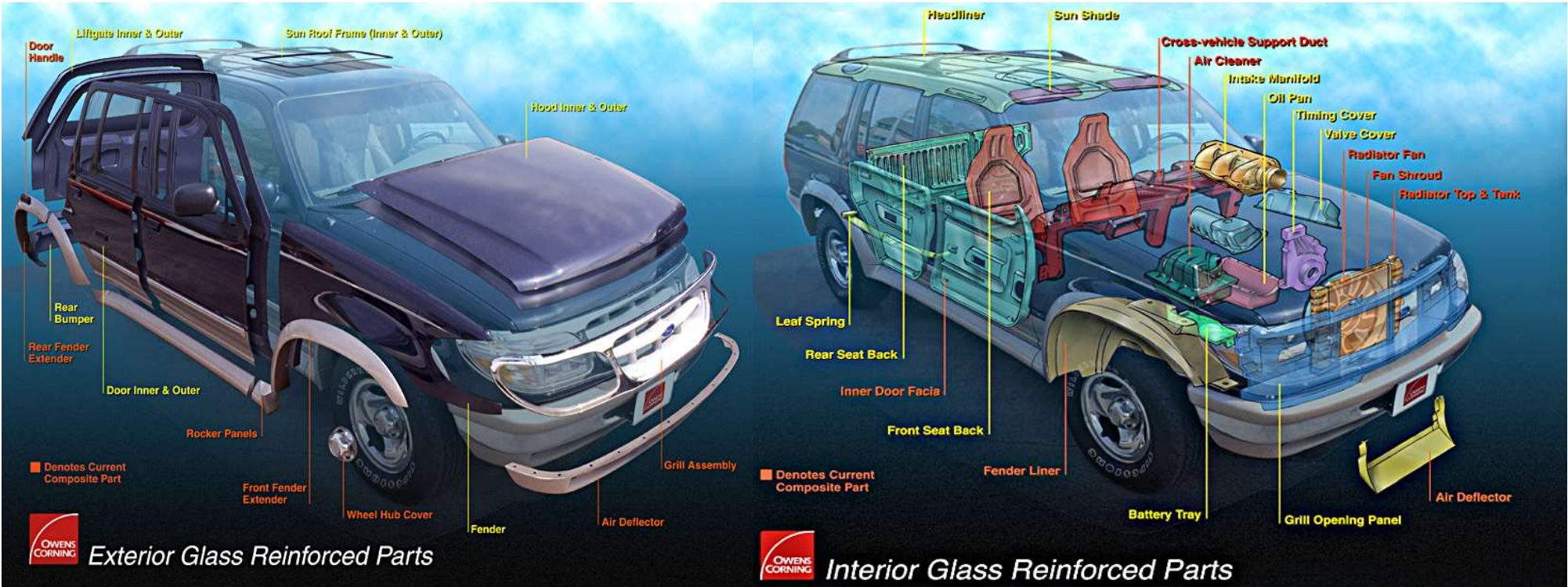

Sport

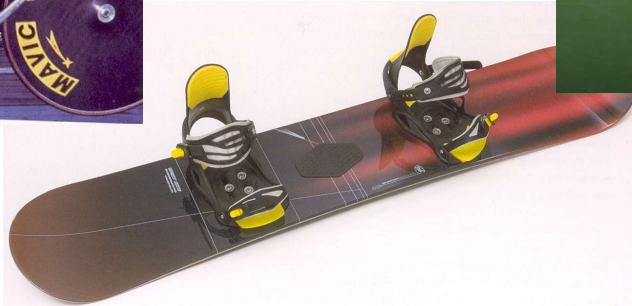

Polymères et composites organiques

Les polymères,dont $5 \cdot 10^6$ t. pour les composites

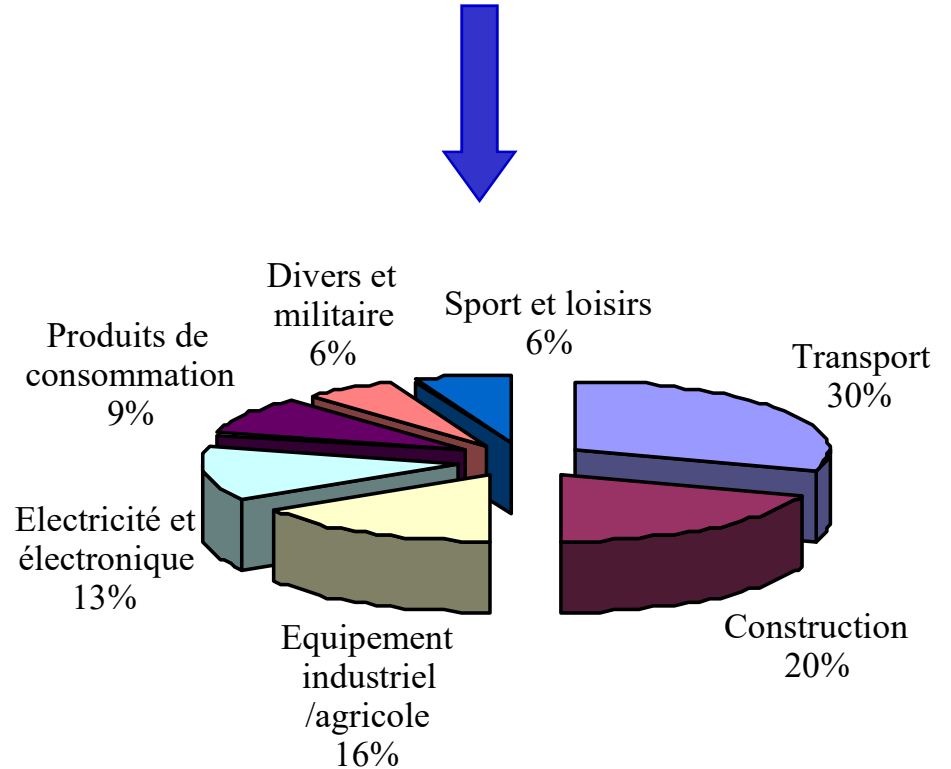
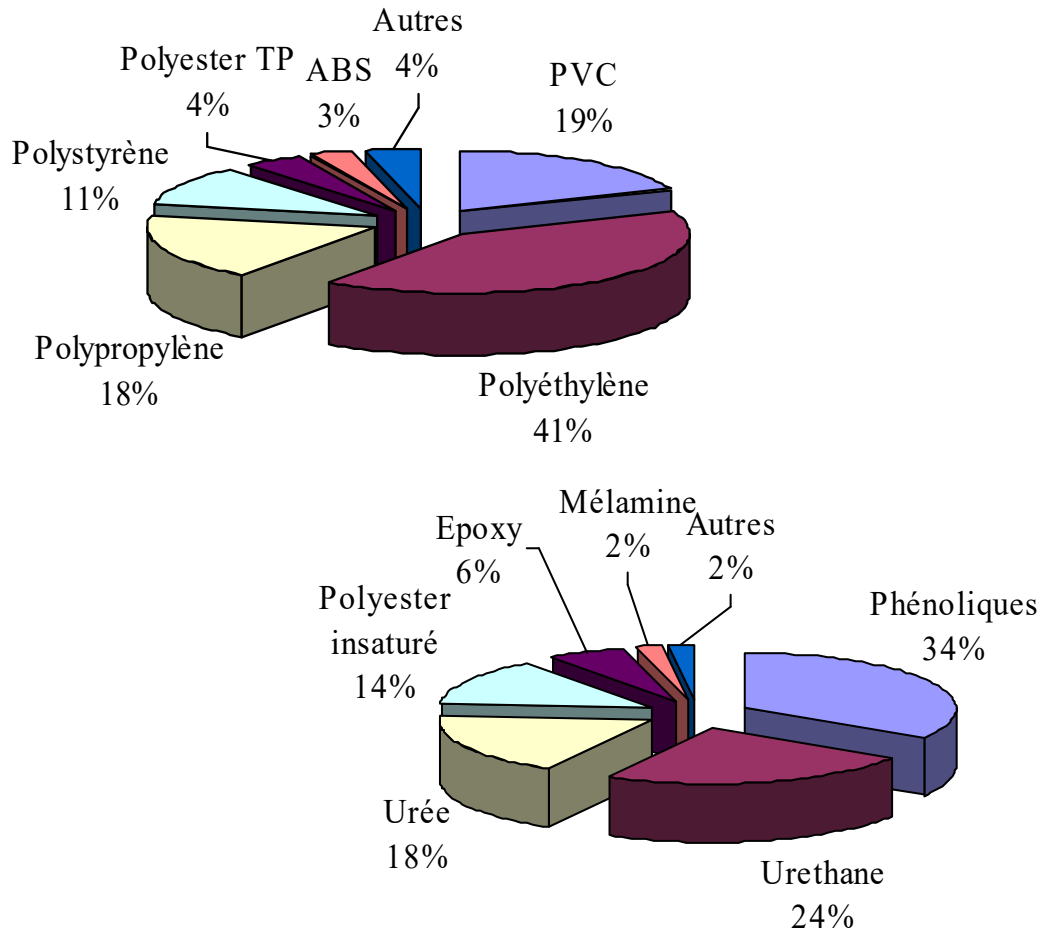

Menu du jour

- ✓ Les composites
- ✓ Quels sont leurs domaines d'applications ?
- Pourquoi des composites ?
- Les catégories de composites organiques
- Propriétés mécaniques spécifiques
- Mise en œuvre
- Recherche et développements actuels

Propriétés: module - densité

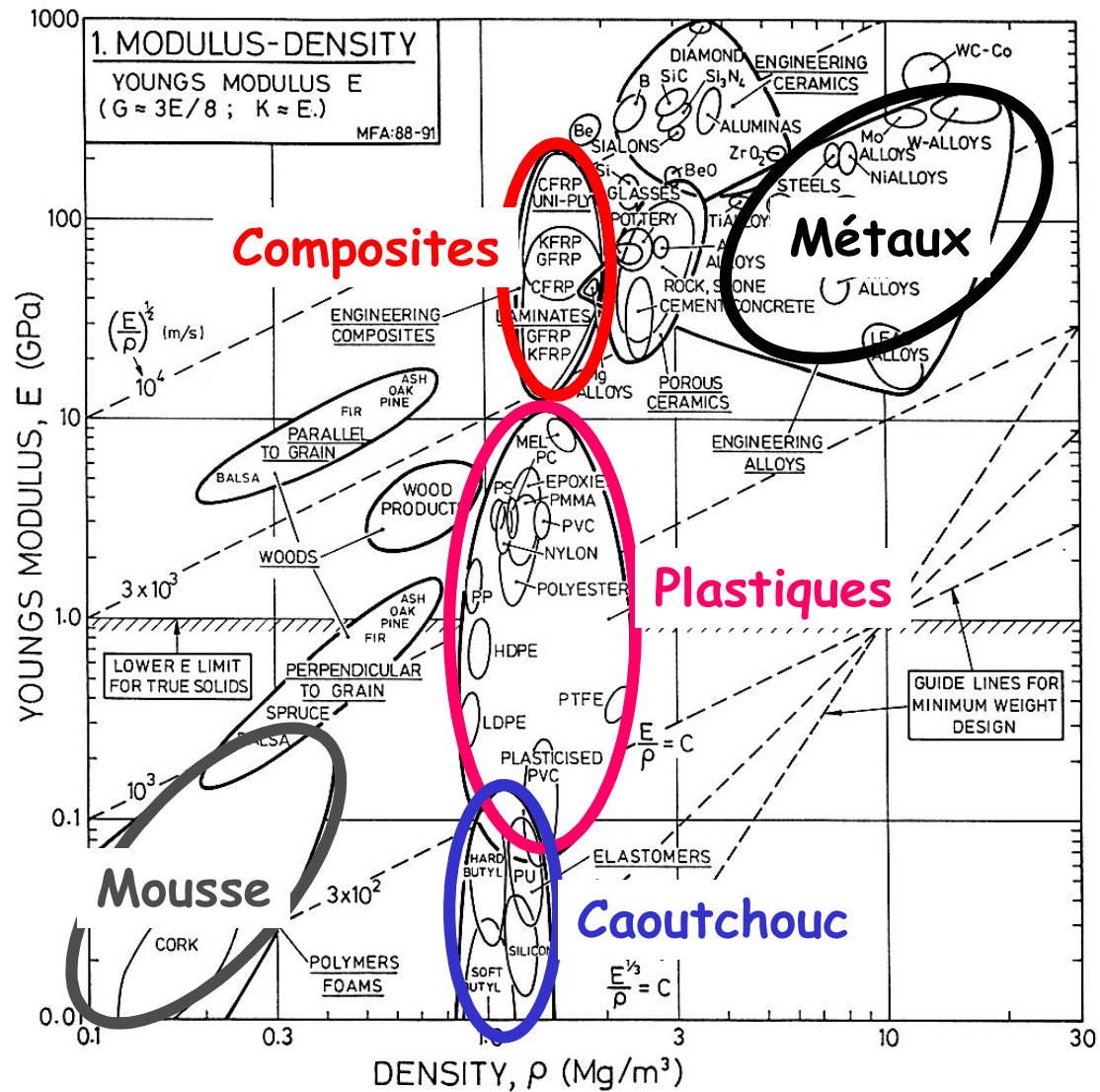
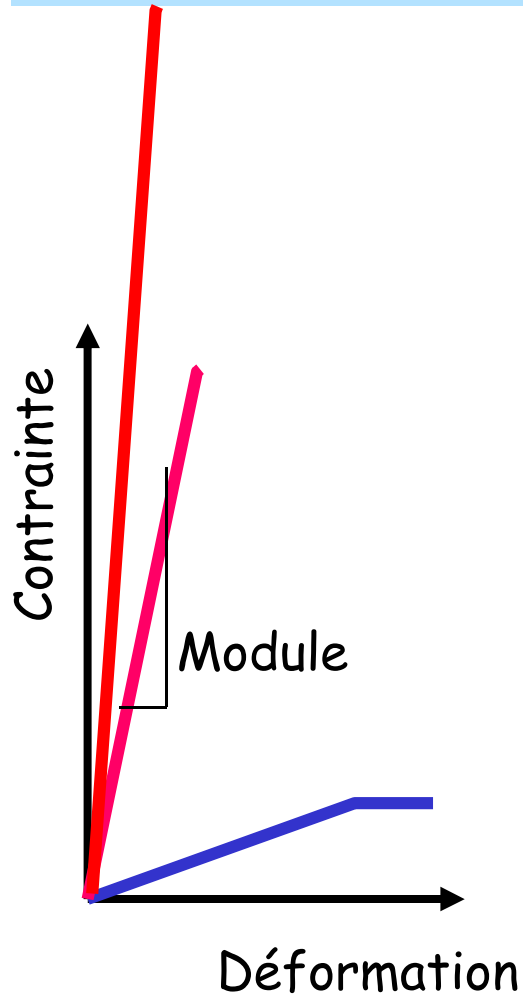

M.F. Ashby, Materials Selection for Mechanical design, Pergamon Press

Comparaisons

	Métaux	Composites	Polymères
Résistance	■		
Résistance au fluage	■		
Coefficient d'expansion thermique faible	■		
Choc à basse température	■		
Résistance à température élevée	■		
Légèreté		■	
Résistance à la fatigue		■	
Lubrification		■	
Résistance à la corrosion		■	
Prix de fabrication faible		■	
Isotropie	■		■

Déplacements rapides, accélérations élevées

$$v = \sqrt{\frac{2 W}{m}}$$

$$v = \frac{\int F dt}{m}$$

$$a = \frac{F}{m}$$

Réduction de poids

Weight reduction

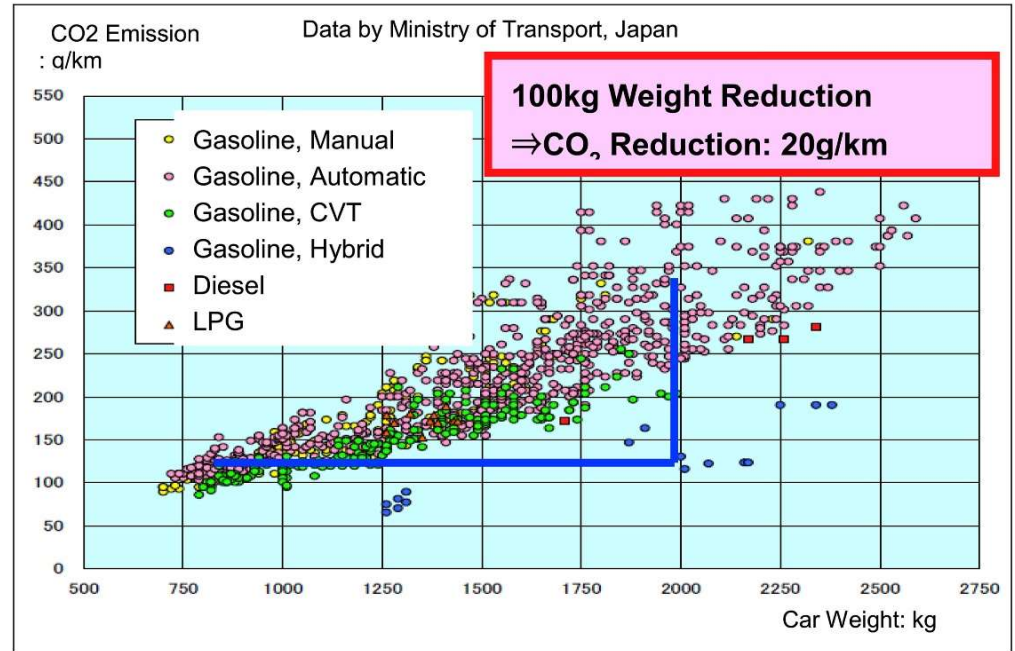
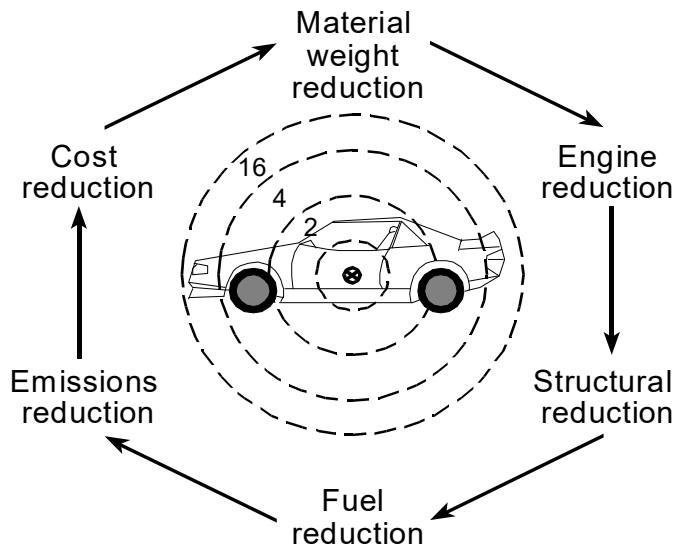

Passenger vehicle weight, (kg)

CSTE,155,8,2018

Fuel cell and hybrid technology



Safety

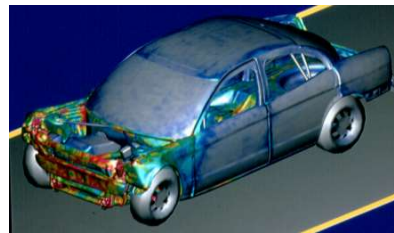

Motivations et défis

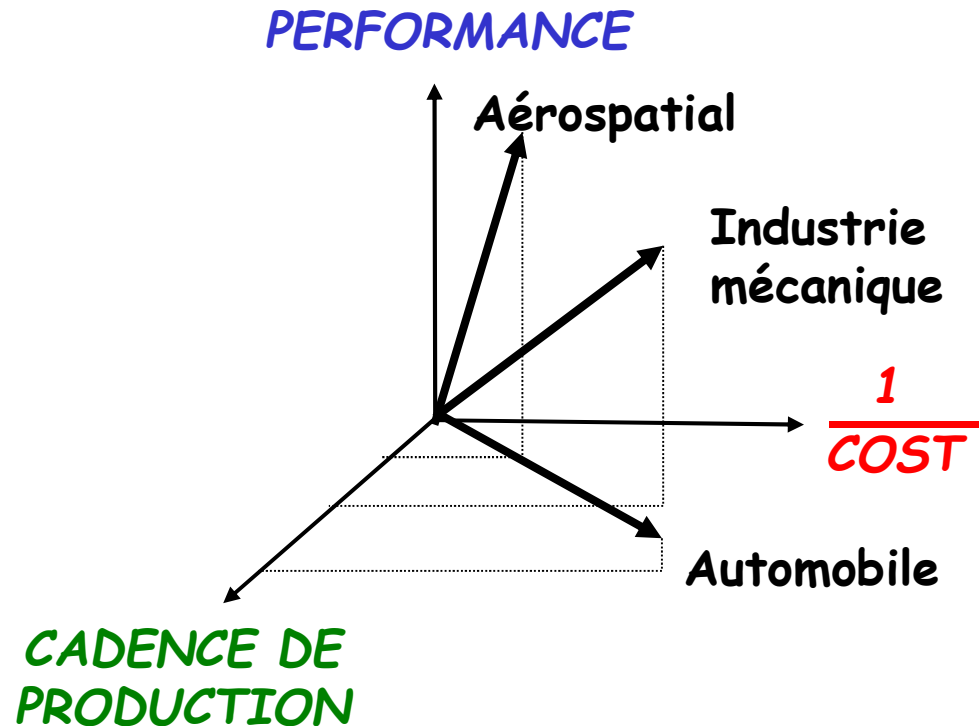

- + Liberté de conception (matériaux, géométrie, design...)
- + Impact environnemental? Plastiques...mais aussi fibres naturelles ou non.

Matériaux composites

Une combinaison et une **synergie** entre deux et plusieurs matériaux

Un matériau constitué d'une matrice continue contenant un renfort sous forme de fibres ou de particules.

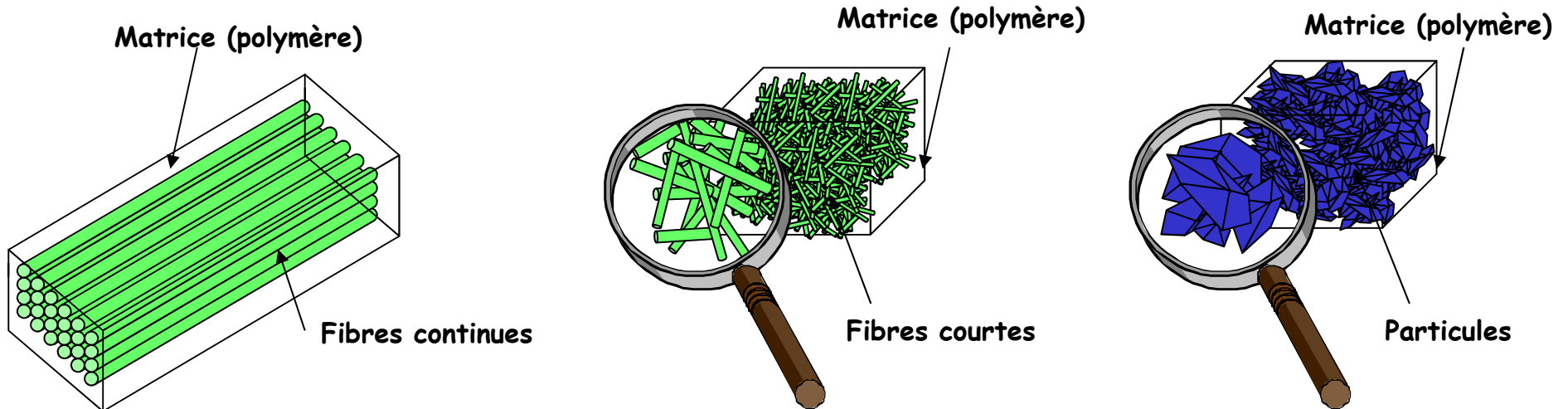

Matériaux composites

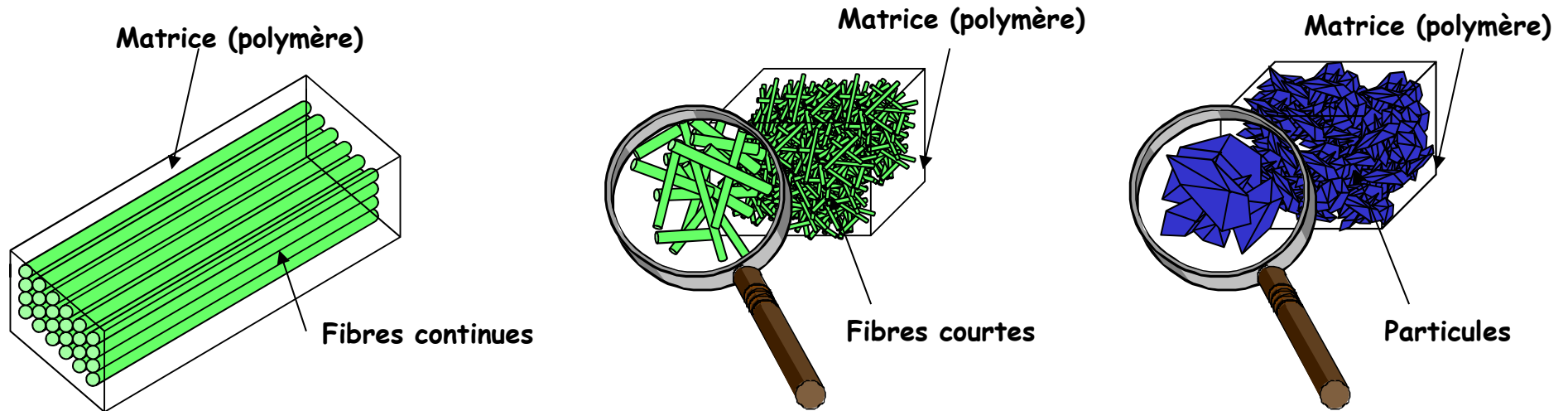

- Fibres orientées
- Composites unidirectionnels (UD)
- Thermodurcis, thermoplastiques
- Haute performance mécanique
- Anisotropie
- Aérospatiale, sport, réservoirs sous pression...

- Distribution de fibres courtes (< 3mm)
- Surtout des matrices thermoplastiques
- Isotropie
- Moulage par injection
- Mécanique, microtechnique, automobile....

- Particules (1-400 μ m), silice, argile...
- Thermodurcs and thermoplastiques
- Amélioration des propriétés
- Stabilité dimensionnelles
- Réduction de coût
- Moulage par injection, coulée
- Mécanique, microtechnique, dentisterie....

Menu du jour

- ✓ Les composites
- ✓ Quels sont leurs domaines d'applications ?
- ✓ Pourquoi des composites ?
- ✓ Les catégories de composites organiques
- ❑ Propriétés mécaniques spécifiques
- ❑ Mise en œuvre
- ❑ Recherche et développements actuels

Structure des composites

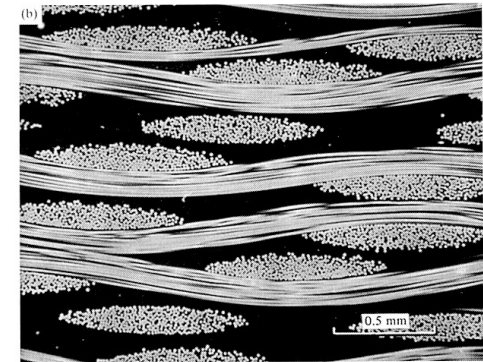
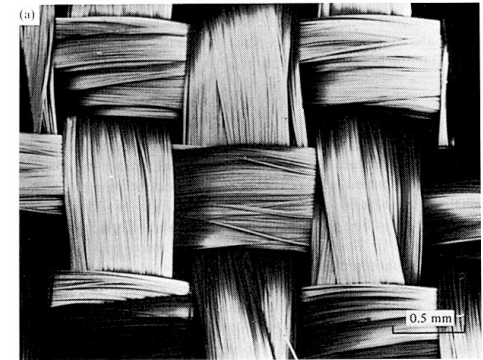
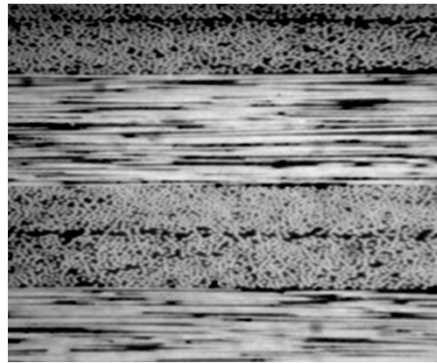
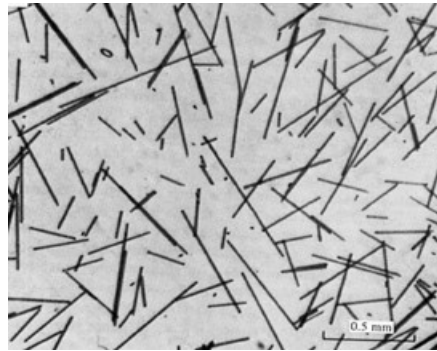
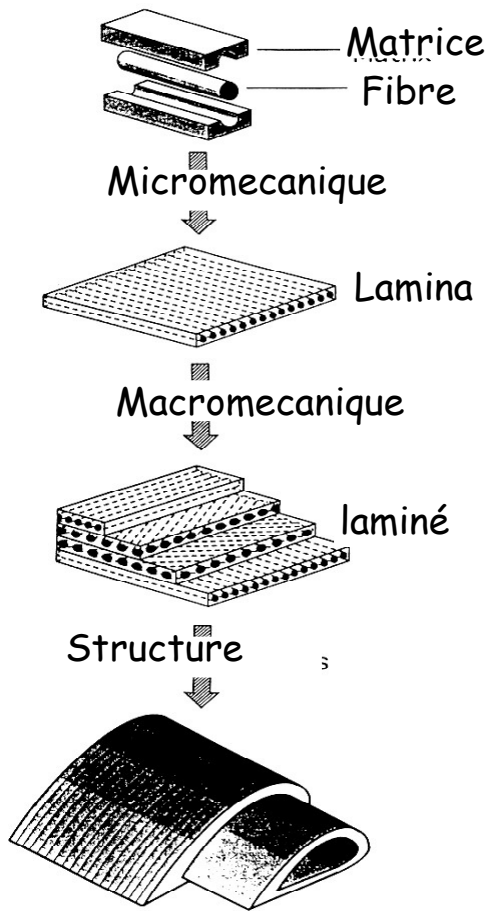

Pourquoi des renforts ?

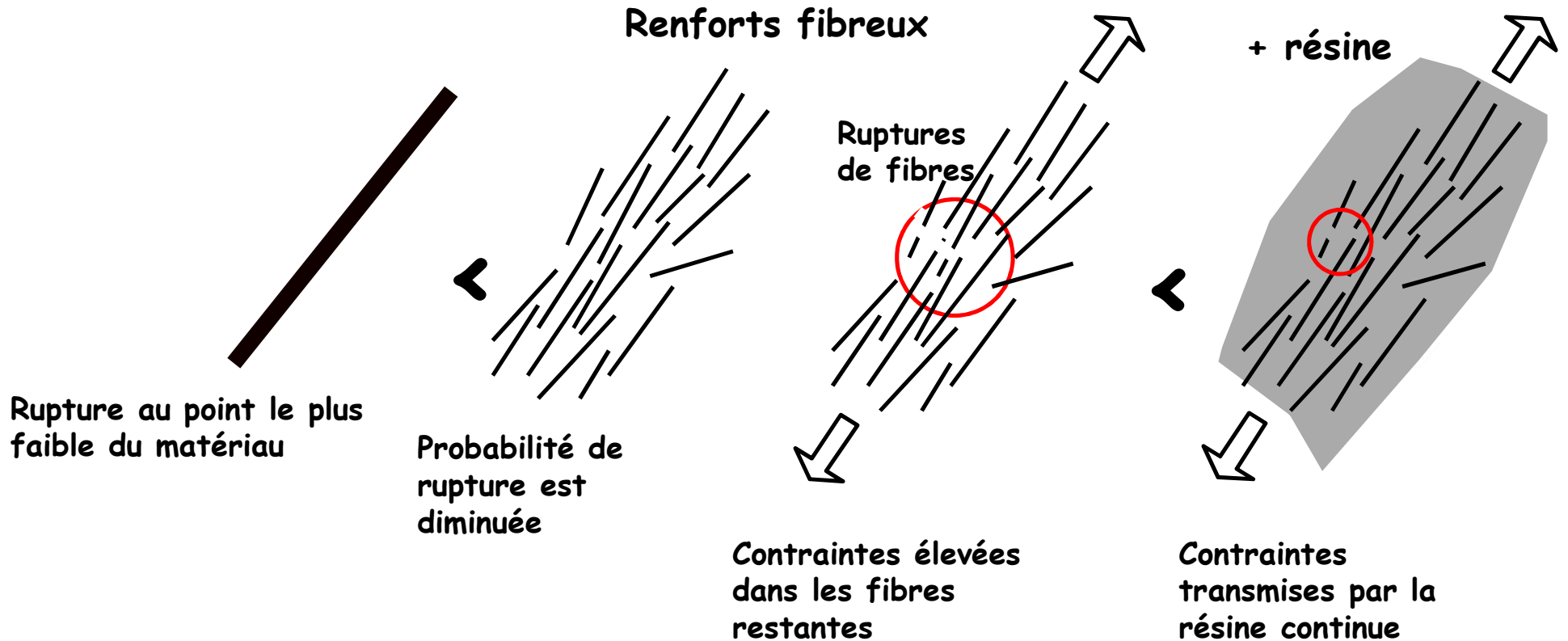

Anisotropie

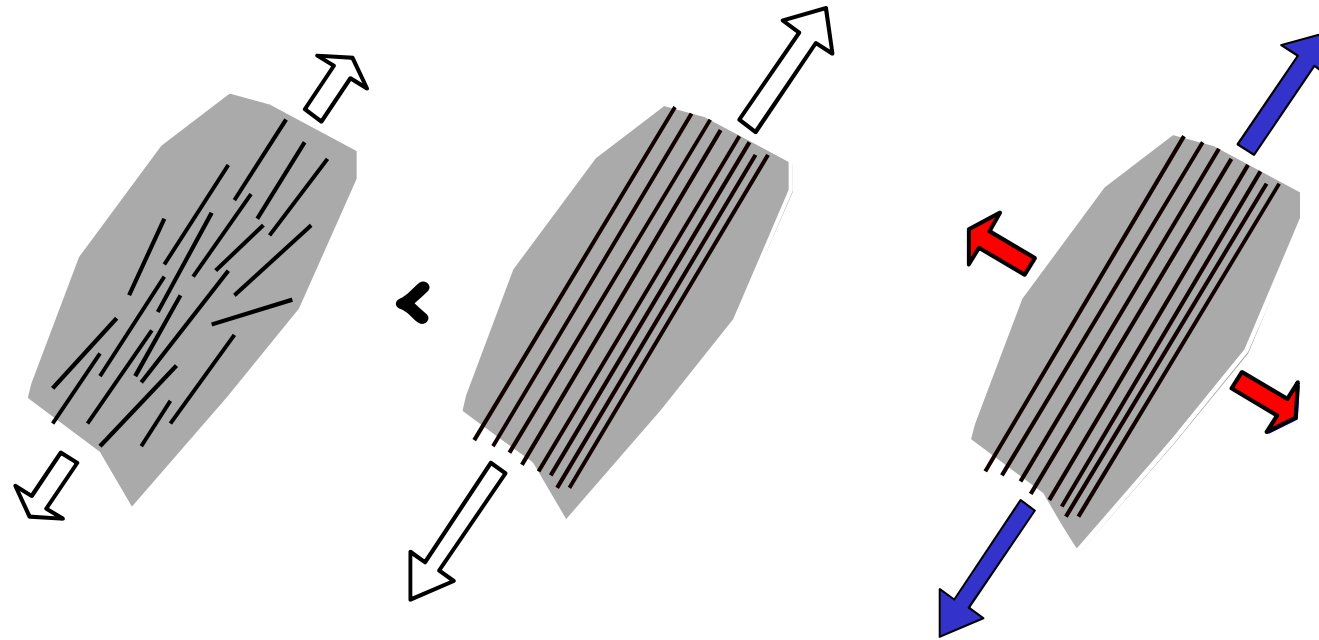

Renforts continus, orientés

Quelle rigidité voulez-vous ?

Fibres de carbone

Fibres de verre

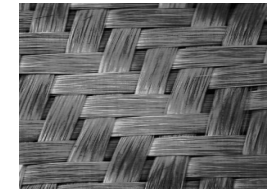
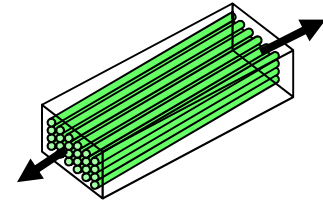
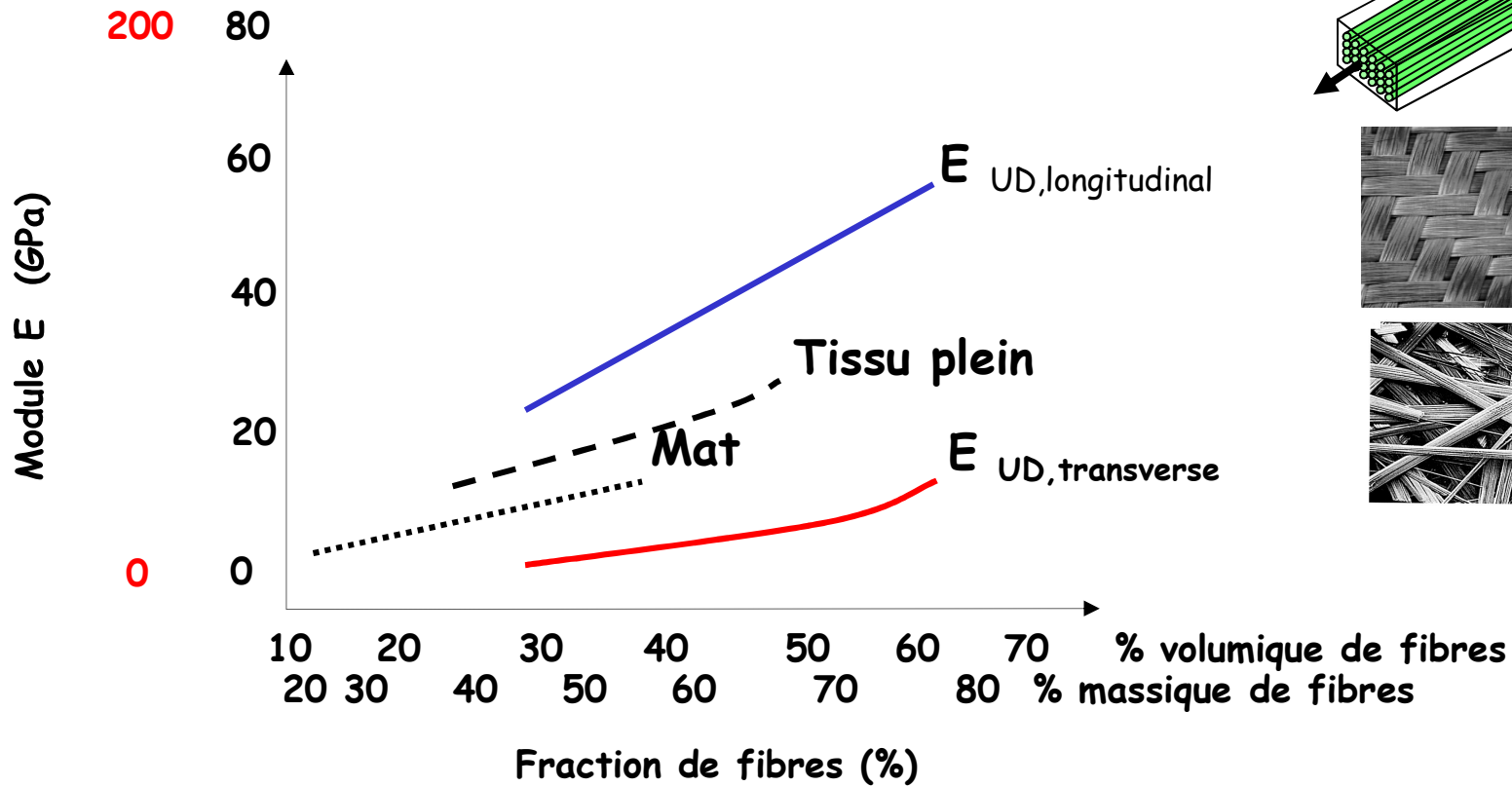

Mécanique des composites : propriétés

Composites à fibres courtes

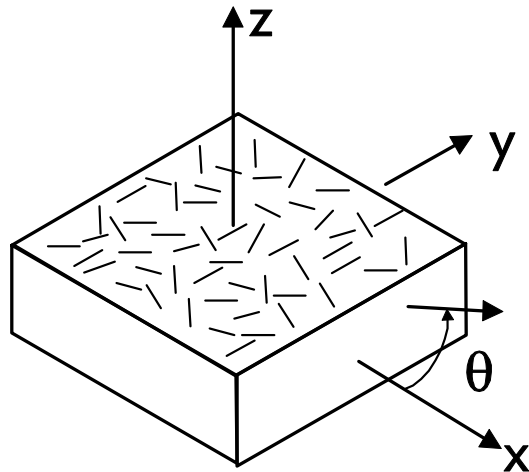

$$E_I = E_f V_f \left[1 - \frac{\tanh(\beta l/2)}{\beta l/2} \right] + E_m V_m$$

Stratifiés

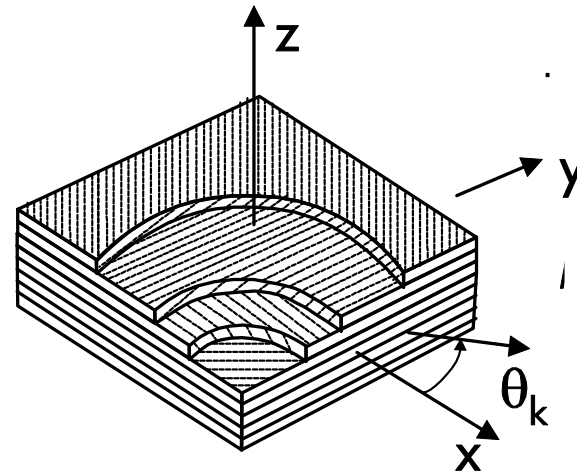

$$E_x = \frac{A_{11} A_{22} - A_{12}^2}{h A_{22}}$$

Résistance des matériaux composites

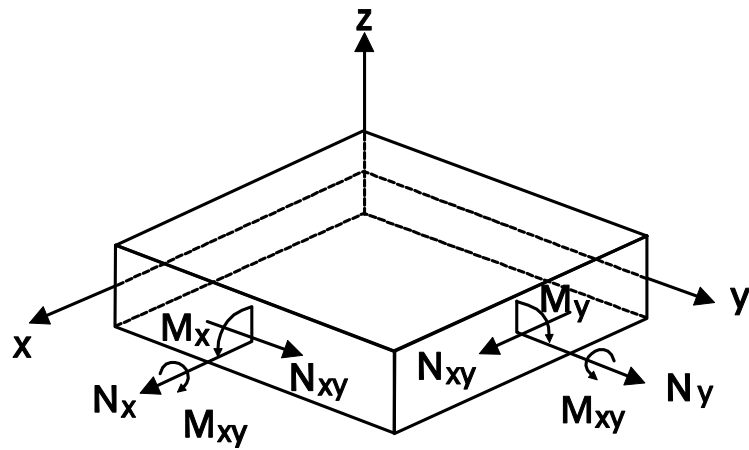

$$\begin{bmatrix} N \\ M \end{bmatrix} = \begin{bmatrix} A & B \\ B & D \end{bmatrix} \begin{bmatrix} \varepsilon^0 \\ \kappa \end{bmatrix}$$

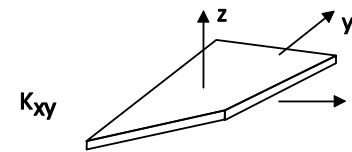
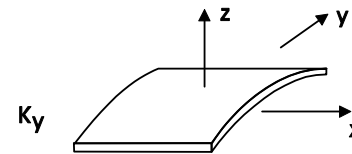
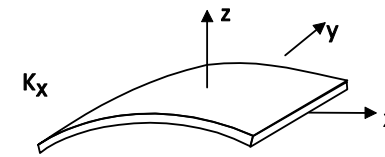

Endommagement et rupture

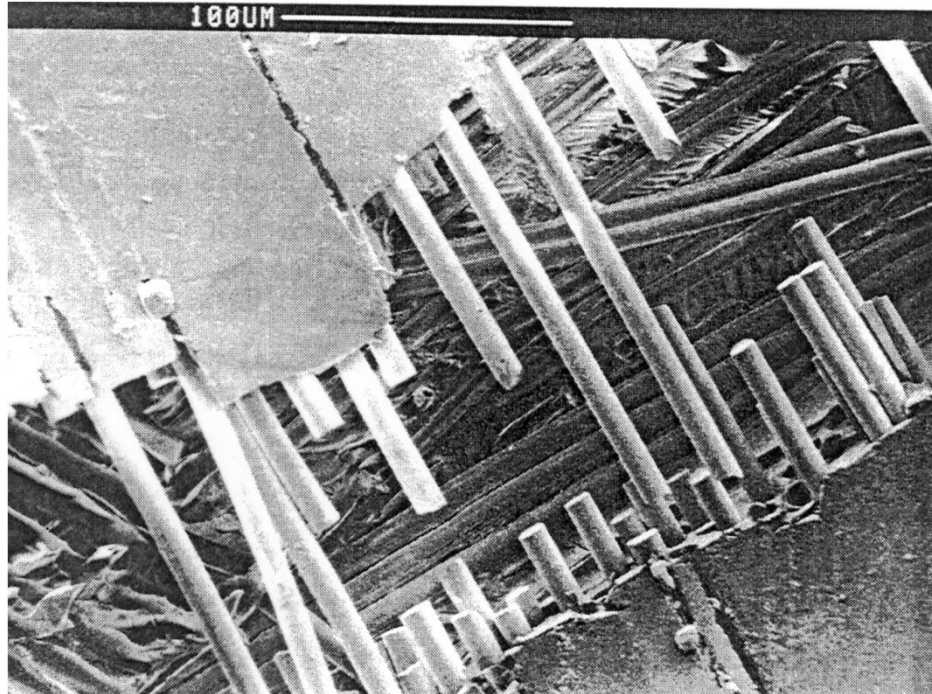

Menu du jour

- ✓ Les composites
- ✓ Quels sont leurs domaines d'applications ?
- ✓ Pourquoi des composites ?
- ✓ Les catégories de composites organiques
- ✓ Propriétés mécaniques spécifiques
- Mise en œuvre
- Recherche et développements actuels

Mise en œuvre des composites

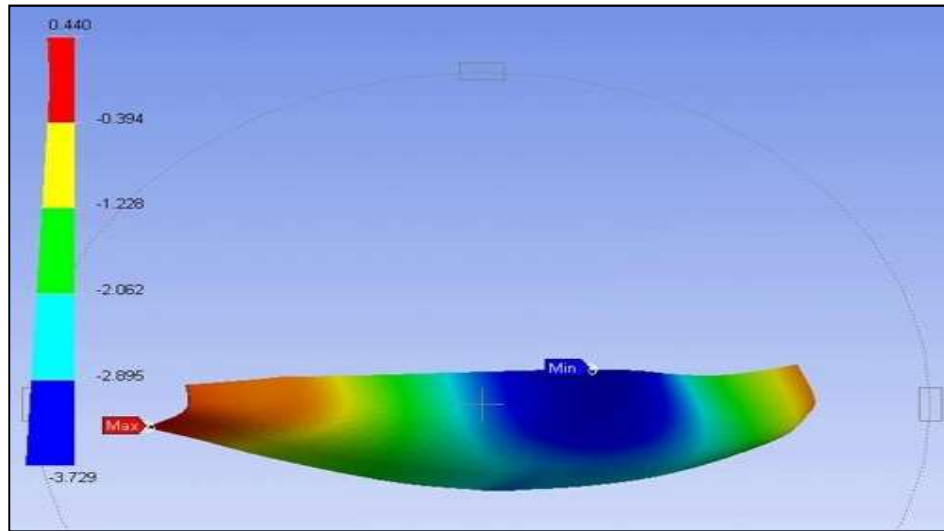

Calculs mécaniques



Le résultat!

Pourquoi?

Tout n'est pas si simple



Porosité, délamination,
Mauvais collage...
-> quel facteur de sécurité?



Mise en œuvre des composites

(a) Préimprégnés → moule → mise en forme

(b) Fibres → renfort textile
Résine → moule → imprégnation par moulage

(c) Fibres courtes → Extrudeuse → produit long
Résine → Extrudeuse

(d) Etc...

Les phénomènes

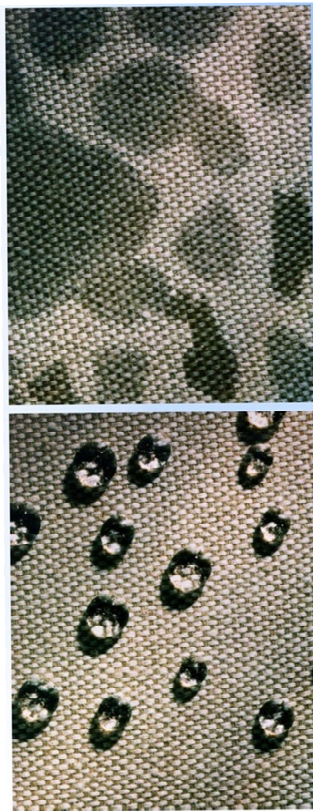

Mouillage

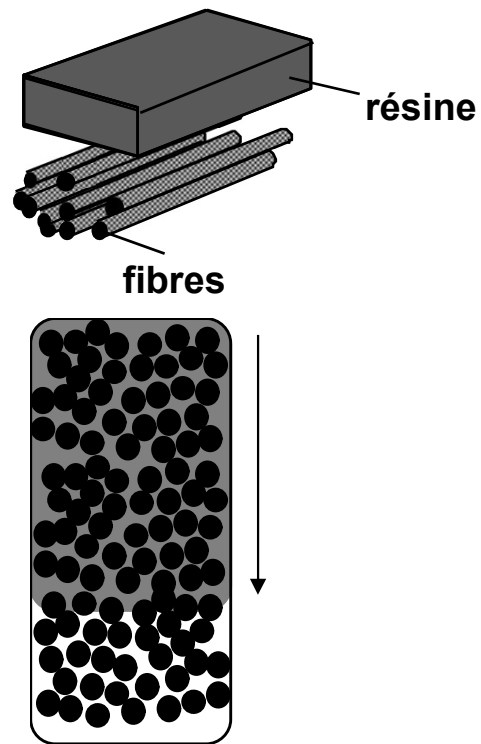

Imprégnation

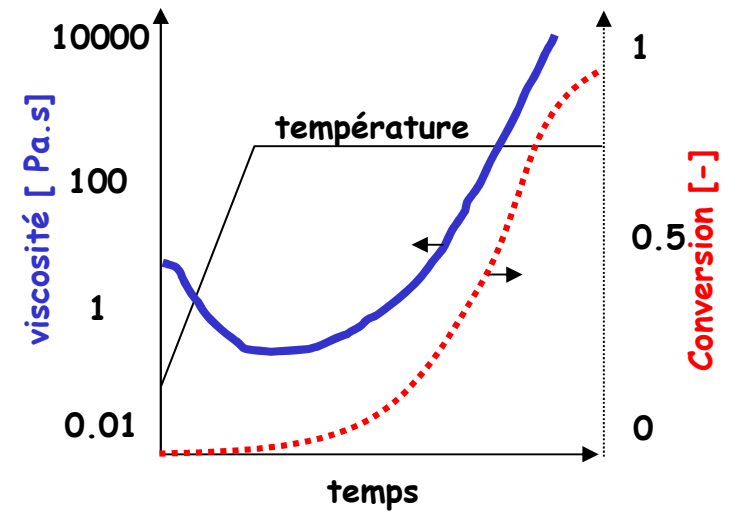

Transformation de la matrice

Les phénomènes

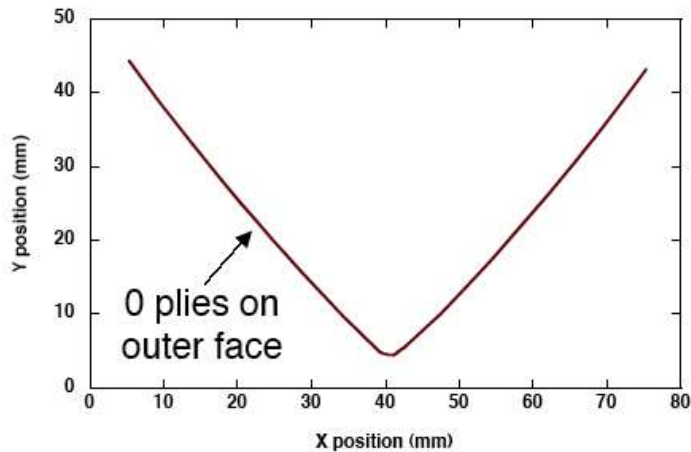

- Cure: 160°C, 3 bar, 2h
- Cool-down: 160 to 25°C over 45 minutes

- Wet lay-up followed by autoclave on a 90° V-shaped tool
- Lay-up, $0_2 90_6$

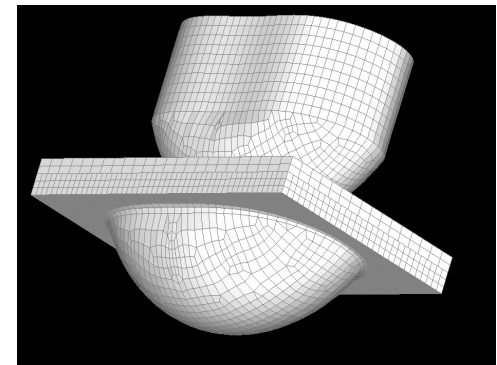

Tranfert de chaleur, écoulement, formage....

Les équations

- Energie de surface
 - Ecoulement de fluide... Newtonien ou non... dans un milieu poreux.
 - Rhéologie des suspensions
 - Mécanique des renforts
 - Transfert de chaleur, cinétique de réaction...
- > pour calculer des fenêtres de mise en oeuvre

Sélection

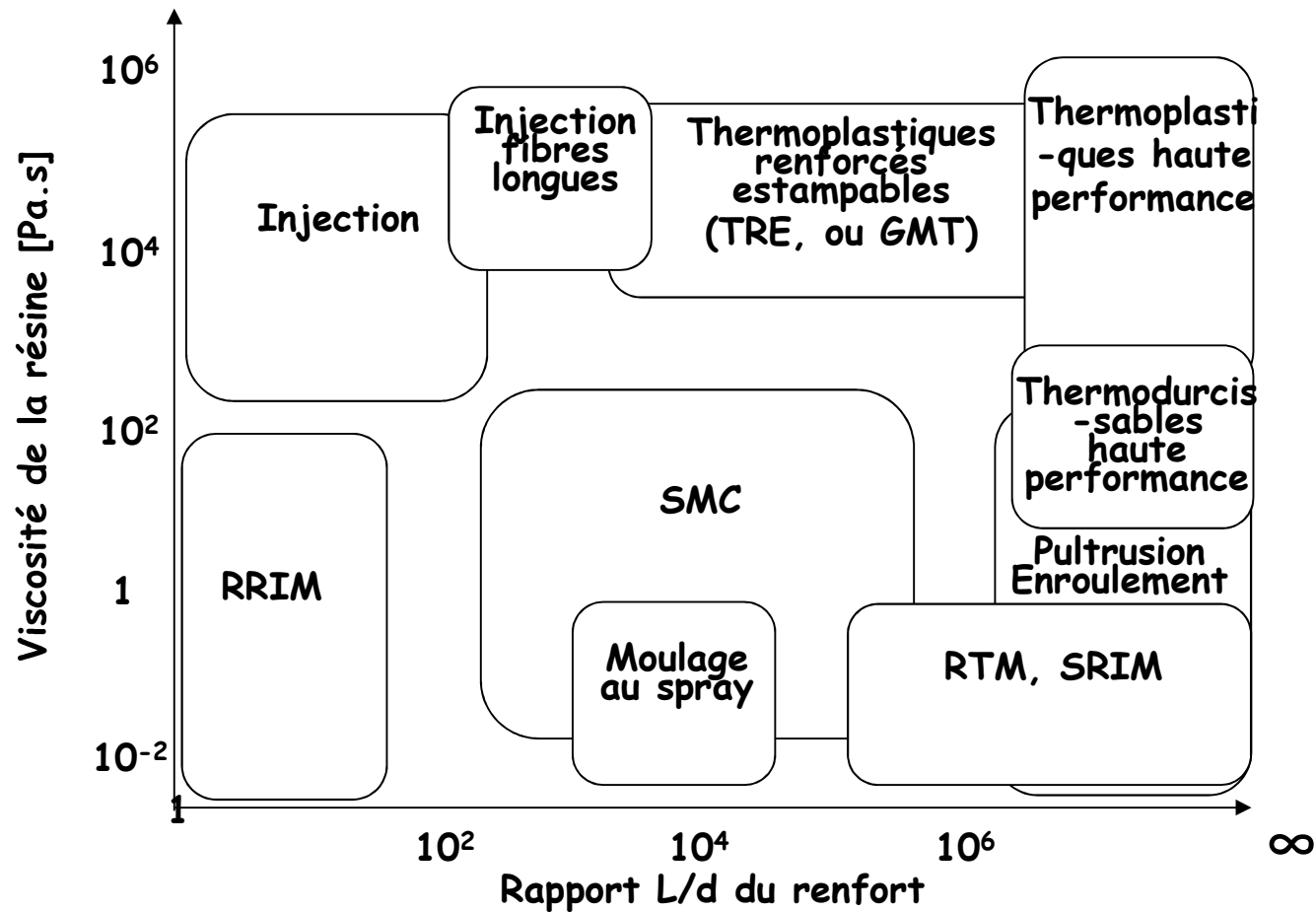

Matériaux/procédés/marchés

Overview of the global composites market in 2019

Main innovations in 2019 – Volume ~11,7 Mt
 – Value⁽¹⁾ ~86 B\$ / 73 B€

Next generation cars will drive market growth

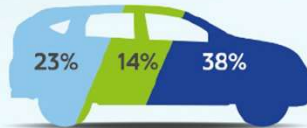

- Autonomous cars penetration in 2040
- Natural gas vehicles CAGR (2000-2030)
- Hydrogen vehicles CAGR (2015-2030)

Global adjacent market amounts to ~22 Mt⁽²⁾



Composites are popular in transportation and construction (Breakdown by application)



Thermosets are the main resin used for composite materials (Breakdown by resin type)



Glass Fibre is the most popular reinforcement (Breakdown by Fibre type)

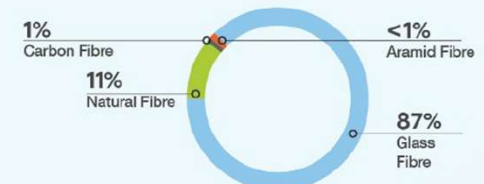

China, & North America are the main composites markets (Breakdown by geography)



Note: (1) Value for end products with composites; (2) Including composites market; (3) Wood-Plastic Composite; (4) Ceramic Matrix Composites; (5) Metal Matrix Composites. Source: Fibr & Co. Interviews, analysis and estimates

Evolution des composites

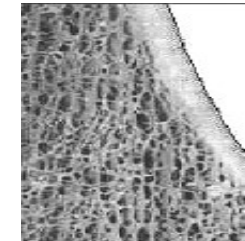
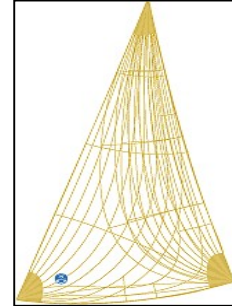
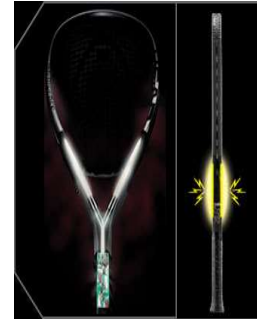

Propriétés mécaniques

Coûts de fabrication

Performances uniques

Fonctions



R&D&A

3D printing

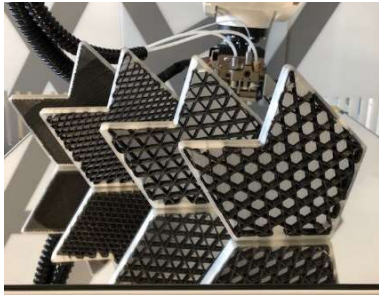

Anisoprint

Functional composites

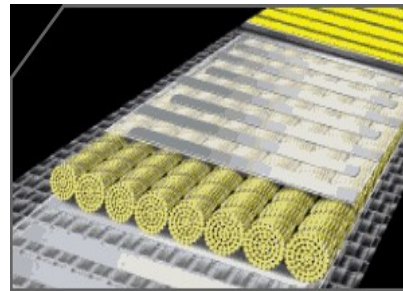

Biocomposites

Natural fibres composites



Museeuw



Resorbable biomedical implants

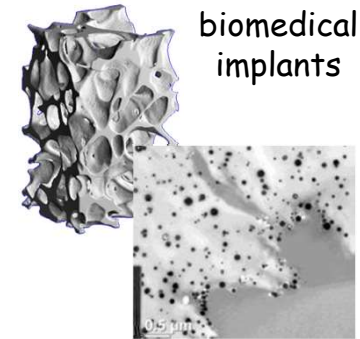

Thin films and micro devices

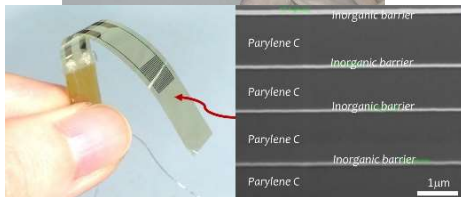
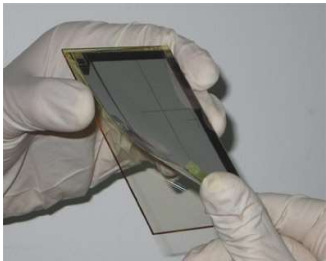

Nanocomposites

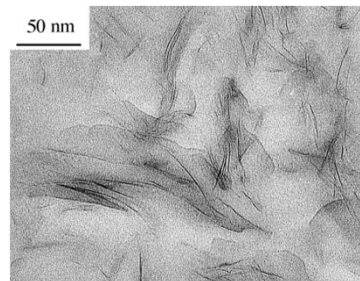

Self-healing composites

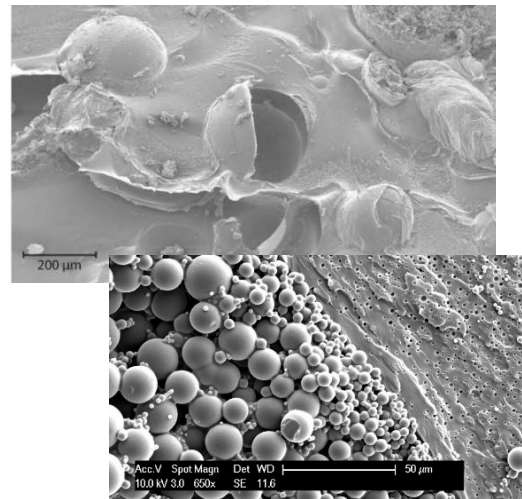

Hydrogel composites

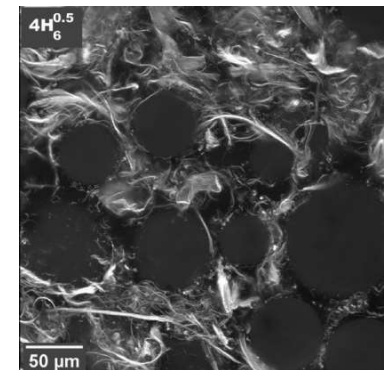

Contenu du cours

- Introduction aux composites
- Constituants
- Théorie et procédés de mise en œuvre
- Micromécanique, Macromécanique
- Illustrations de choix de matériaux, de mise en œuvre, de conception...
- Exercices

Et quelques principes de recyclage.

- Bases pour le cours MSE 440 de Master Technologie des composites
 - Composites textiles, Structures sandwich
 - Nanocomposites, Biocomposites etc..
 - Applications

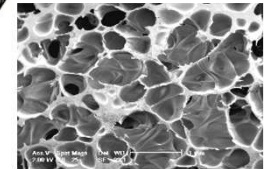
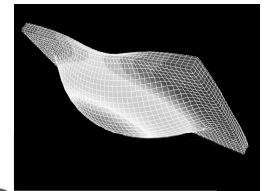

Learning outcomes

A la fin de ce cours l'étudiant doit être capable de:

- Appliquer les méthodes de calculs pour déterminer les propriétés mécaniques des matériaux anisotropes
- Dimensionner des structures en composites (simples)
- Proposer des matériaux en choisissant leur composition et les procédés de fabrication, pour une application donnée
- Comparer les matériaux composites entre eux
- Discuter les tests de caractérisation des composites
- Distinguer les avantages et limitations des procédés.

- Dialoguer avec des professionnels d'autres disciplines.
- Utiliser les outils informatiques courants ainsi que ceux spécifiques à leur discipline.

5 TPs sur la mise en oeuvre et les propriétés des composites

Examen oral en Janvier (5 minutes de préparation, 10 minutes de questions)

Biblio

- **Les matériaux composites organiques,**
Traité des Matériaux, vol 15, PPUR, EPFL-Lausanne
- **Références spécifiques par sujet traité**

Les composites polymères : MSE340-2023

CALENDRIER	MSE 340 COMPOSITES			
	TP composites	Cours composites		
	lu 8-12h	lu 14-16h	BC01	
lundi, 18 septembre 2023	férié	férié		
lundi, 25 septembre 2023	Organisation	Cours	Intro aux composites	PEB/VM
lundi, 2 octobre 2023	TP	Cours	Constituants des composites	VM/PEB
lundi, 9 octobre 2023		Cours	Bases théoriques de la mise en œuvre des composites	VM
lundi, 16 octobre 2023	TP	Cours	Procédés de mise en œuvre des composites	VM
lundi, 23 octobre 2023		Cours	Procédés de mise en œuvre des composites	VM
lundi, 30 octobre 2023	TP	Cours	Intro à la mécanique des composites	PEB
lundi, 6 novembre 2023		Cours	Micromécanique	PEB
lundi, 13 novembre 2023	TP	Cours	Micro-macromécanique d'un pli	PEB
lundi, 20 novembre 2023		Cours	Macromécanique des stratifiés	PEB
lundi, 27 novembre 2023	TP	Cours	Exercices Esacomp	PEB
lundi, 4 décembre 2023		Cours	Résistance, endommagement et critères de ruptures	PEB
lundi, 11 décembre 2023	TP	Cours	Exercices Esacomp	PEB
lundi, 18 décembre 2023		Cours	Exemples de fabrication et d'application des composites	PEB/VM
EVALUATION: 1/3 rapports des TP, 2/3 examen oral				