

Reinforcement Learning and the Brain:

Three-factor learning rules and 'brain-style' computing

Introduction

Objectives for today:

- **three-factor learning rules can be implemented by the brain**
- **three-factor rules are consistent with RL**
- **eligibility traces link correlations with delayed reward**
- **the dopamine signal has signature of the TD error**
- **local learning rules: 2-factor and three-factor**

Reading for this week:

**Sutton and Barto, Reinforcement Learning
(MIT Press, 2nd edition 2018, also online)**

Chapter: 15

Background reading:

(1) *Fremaux, Sprekeler, Gerstner (2013)* Reinforcement learning using a continuous-time actor-critic framework with spiking neurons
PLoS Computational Biol. doi:10.1371/journal.pcbi.1003024

(2) *Gerstner et al. (2018)* Eligibility traces and plasticity on behavioral time scales: experimental support for neoHebbian three-factor learning rules, *Frontiers in neural circuits*
<https://doi.org/10.3389/fncir.2018.00053>

(3) *Wolfram Schultz et al., (1997)* A neural substrate of prediction and reward, *SCIENCE*,
<https://www.science.org/doi/full/10.1126/science.275.5306.1593>

Review: Biological Motivation of RL



Reinforcement Learning (RL)

→ **Learning by reward**

Field has two roots:

→ Optimization/Markov

Decision Process (MDP)

→ **Biology**



Questions for today:

- What elements of RL are 'bio-plausible'?
- Can the brain implement RL?

Previous slide.

animals and humans are able to learn from rewards. This observation has been one of the major drives of RL.

(the other major drive is the theory of Markov Decision Models)

The question then is:

1. can we make the relation to biology more precise?
2. Can we exploit biological insights for unconventional computer hardware?

To answer these questions let us focus on the 'Learning Rule'.

Review: Advantage Actor-Critic = 'REINFORCE' with TD signal

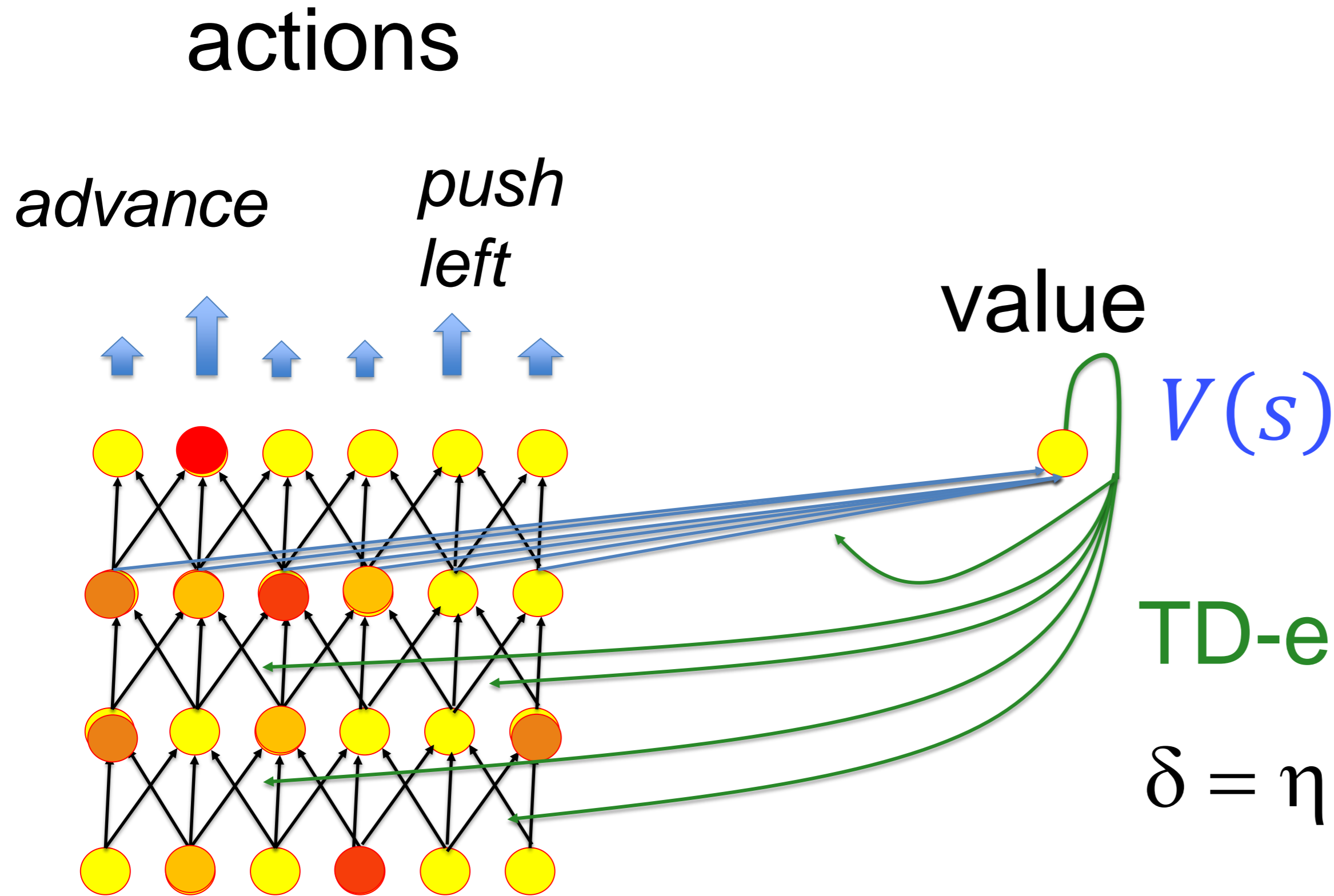

- Estimate $V(s)$
- learn via TD error

The update of parameters depends on the TD error!
The algo for the update is called a 'learning rule'.

Previous slide.

Let us focus on the 'Learning Rule' or 'update algorithm' in the actor-critic setup.

There are weights w leading to the actor and other parameters θ leading to the critic.

Learning rule means that we analyze how these parameters change. Thus 'learning rule' in biology is a term that refers to the 'parameter update algorithm' in the corresponding mathematical learning model.

Review: Advantage Actor-Critic with Eligibility traces

Actor–Critic with Eligibility Traces (continuing), for estimating $\pi_{\theta} \approx \pi_*$

Input: a differentiable policy parameterization $\pi(a|s, \theta)$

Input: a differentiable state-value function parameterization $\hat{v}(s, \mathbf{w})$

Algorithm parameters: $\lambda^{\mathbf{w}} \in [0, 1]$, $\lambda^{\theta} \in [0, 1]$, $\alpha^{\mathbf{w}} > 0$, $\alpha^{\theta} > 0$

Initialize state-value weights $\mathbf{w} \in \mathbb{R}^d$ and policy parameter $\theta \in \mathbb{R}^{d'}$ (e.g., to $\mathbf{0}$)

Initialize $S \in \mathcal{S}$ (e.g., to s_0)

$\mathbf{z}^{\mathbf{w}} \leftarrow \mathbf{0}$ (d -component eligibility trace vector)

$\mathbf{z}^{\theta} \leftarrow \mathbf{0}$ (d' -component eligibility trace vector)

Loop forever (for each time step):

$A \sim \pi(\cdot|S, \theta)$

Take action A , observe S', r

$\delta \leftarrow r + \gamma \hat{v}(S', \mathbf{w}) - \hat{v}(S, \mathbf{w})$

$\mathbf{z}^{\mathbf{w}} \leftarrow \lambda^{\mathbf{w}} \mathbf{z}^{\mathbf{w}} + \nabla \hat{v}(S, \mathbf{w})$

$\mathbf{z}^{\theta} \leftarrow \lambda^{\theta} \mathbf{z}^{\theta} + \nabla \ln \pi(A|S, \theta)$

$\mathbf{w} \leftarrow \mathbf{w} + \alpha^{\mathbf{w}} \delta \mathbf{z}^{\mathbf{w}}$

$\theta \leftarrow \theta + \alpha^{\theta} \delta \mathbf{z}^{\theta}$

$S \leftarrow S'$

The algo for the update is the ‘learning rule’.

*Adapted from
Sutton and Barto*

Previous slide. Review from DeepRL1

Red box:

Parameters in the advantage actor critic change proportional to

- The TD error delta
- The derivative of the value function for the critic
- The derivative of the log policy for the actor

In this version of the algo we also have eligibility traces. Set $\lambda=0$ to get a version without eligibility traces.

In the example on the next page eligibility traces are important.

Quiz: Relation of Advantage-Actor-Critic to other Policy Gradient Algos

Assume the transition to state x^{t+1} with a reward of r^{t+1} after taking action a^t at state x^t . The learning rule for the Advantage Actor-Critic with Eligibility traces is

'learning rule'
of Advantage
Actor-Critic
with eligibility trace

$$\begin{aligned}\delta &\leftarrow r^{t+1} + \gamma \hat{v}_w(x^{t+1}) - \hat{v}_w(x^t) \\ z^w &\leftarrow \lambda^w z^w + \nabla_w \hat{v}_w(x^t) \\ z^\theta &\leftarrow \lambda^\theta z^\theta + \nabla_\theta \pi_\theta(a^t | x^t) \\ w &\leftarrow w + \alpha^w z^w \delta \\ \theta &\leftarrow \theta + \alpha^\theta z^\theta \delta\end{aligned}$$

[] We get the Advantage Actor-Critic **without eligibility trace** if we set $\lambda^w = \lambda^\theta = 0$.

[] We get REINFORCE **without baseline** (with eligibility trace) if set $\delta \leftarrow r^{t+1}$

[] We get REINFORCE **without baseline** and **without eligibility trace**

$$\text{if set } \delta \leftarrow R = r^{t+1} + \gamma r^{t+2} +$$

[] REINFORCE **without baseline** and **without eligibility trace** has many terms

propto $\nabla_\theta \pi_\theta(a^t, x^t), \nabla_\theta \pi_\theta(a^{t+1}, x^{t+1}), \dots$ and is therefore not an online algorithm

Previous slide. Your notes. All these algorithms have been covered in the lecture on policy gradient methods.

R denotes the return (sum of discounted rewards, starting from state t)

Relation of Advantage-Actor-Critic to other Policy Gradient Algos

Assume the transition to state x^{t+1} with a reward of r^{t+1} after taking action a^t at state x^t . The learning rule for the Advantage Actor-Critic with Eligibility traces is

**‘learning rule’
of Advantage
Actor-Critic
with eligibility trace**

$$\begin{aligned}\delta &\leftarrow r^{t+1} + \gamma \hat{v}_w(x^{t+1}) - \hat{v}_w(x^t) \\ z^w &\leftarrow \lambda^w z^w + \nabla_w \hat{v}_w(x^t) \\ z^\theta &\leftarrow \lambda^\theta z^\theta + \nabla_\theta \pi_\theta(a^t | x^t) \\ w &\leftarrow w + \alpha^w z^w \delta \\ \theta &\leftarrow \theta + \alpha^\theta z^\theta \delta\end{aligned}\tag{1}$$

- Learning rules of other ONLINE RL policy gradient models are special cases of (1).
- We take (1) as a starting point to discuss the relation with the brain

Can such a learning rule be implemented in the brain?

Previous slide. Review from DeepRL1

In the following we take the Advantage Actor Critic as our Reference Model.

Other Algorithms in the Family of Policy Gradients can be identified as special cases.

The first big question of this lecture is:

Can such a learning rule (update algorithm) be implemented in the brain?

The second big question of this lecture is (next slide):

Can the elements of an actor-critic architecture be implemented in the brain?

Review: Maze Navigation with Advantage Actor-Critic

Continuous action space:
ring of 360 action neurons

Value map:
Several identical neurons

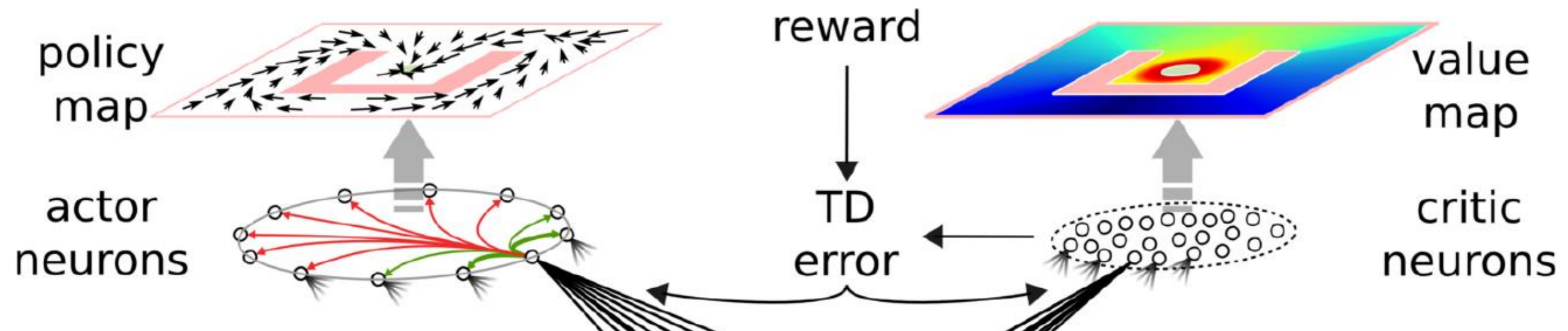

Can this structure be implemented in the brain?

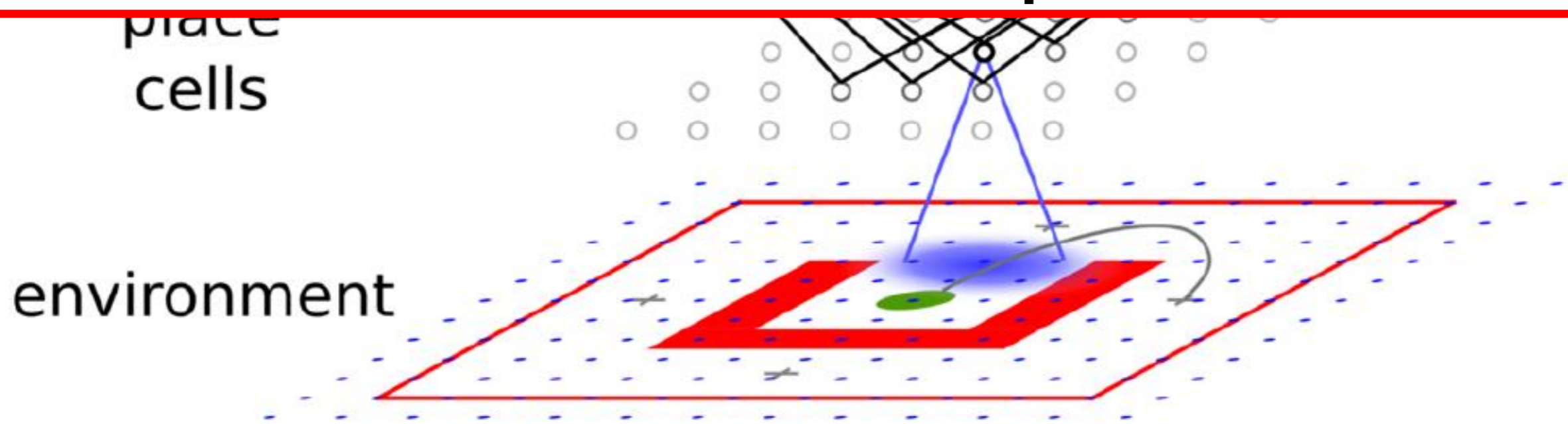

Continuous state space:
Represented by Gaussian basis functions

Figure 1. Navigation task and actor-critic network. From bottom to top: the simulated agent evolves in a maze environment, until it finds the reward area (green disk), avoiding obstacles (red). Place cells maintain a representation of the position of the agent through their tuning curves. Blue shadow: example tuning curve of one place cell (black); blue dots: tuning curves centers of other place cells. Right: a pool of critic neurons encode the expected future reward (value map, top right) at the agent's current position. The change in the predicted value is compared to the actual reward, leading to the temporal difference (TD) error. The TD error signal is broadcast to the synapses as part of the learning rule. Left: a ring of actor neurons with global inhibition and local excitation code for the direction taken by the agent. Their choices depending on the agent's position embody a policy map (top left).

doi:10.1371/journal.pcbi.1003024.q001

This is an example task and architecture that will serve as a reference throughout this lecture. The network is not very deep, but it is powerful since states are represented by Gaussian basis functions. The parameters that need to be learnt are the weights to the actor and the connections to the critic.

Bottom: In the specific biological application, Gaussian basis functions are also called place cells.

Right: The critic could be a single neuron, but it is implemented in this application by pool of several independent identical neurons (that essentially learn the same value).

Left: Action choices are represented by a ring of 360 neurons. In order to generalize well in action space neighboring neurons activate each other while neurons encoding opposite directions inhibit each other. This is a way to implement an inductive bias into the architecture: if direction 88 is good, then direction 89 is typically nearly as good.

(This slide is a review of an earlier lecture).

Learning Rules

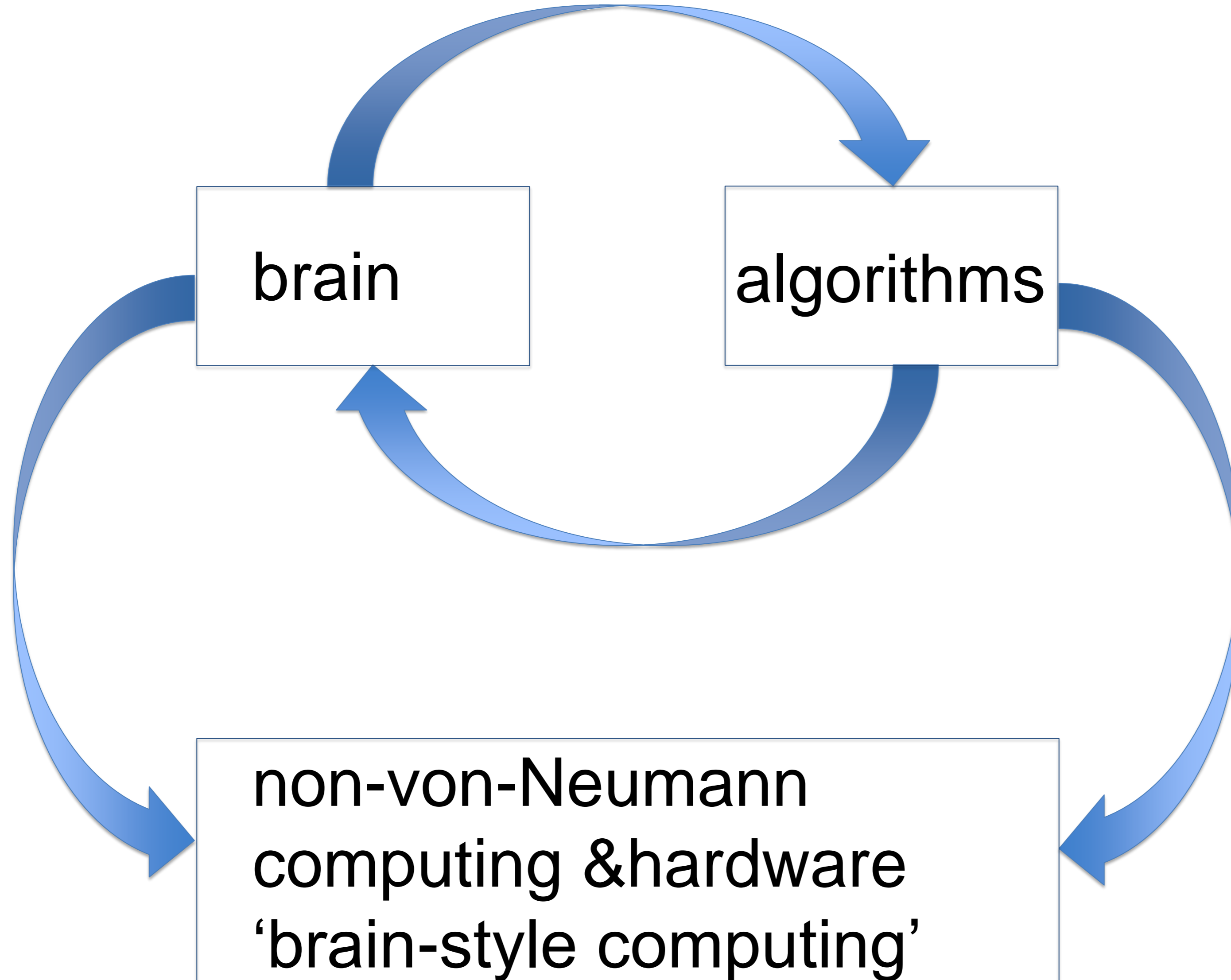

Previous slide.

Our aim is to connect formal RL algorithms (right-hand side) with elements and structures in the brain (left-hand side).

This comparison will lead us to a non-von-Neumann computing paradigm that is fully distributed without central control, central memory, or central processing units.

This computing paradigm has sometimes been called 'brain-style computing'.

Aside: similar 'non-von-Neumann' computing architectures are also seriously considered today in the hardware community for next-generation chip design or next generation materials! (→ separate lecture)

Questions for this Lecture

- Does the brain implement reinforcement learning algorithms?
- Can the brain implement an actor-critic structure?

- What can we learn without Backprop?
- Applications of 'brain-style computing'?
- Properties of learning rules: 'local', 'Hebbian', 'Three-factor'

There are big research fields interested in these questions:

- Computational neuroscience
- Cognitive neuroscience
- Neuro-economics
- Clinical Neuroalscience of Addiction

Previous slide.

Program for this week.

In this introduction, we have reviewed some aspects of RL in an actor-critic structure, in particular the online 'learning rule', i.e., the algorithm for the parameter update after each step of the agent. In the following we focus on the learning rule and go back and forth between algorithms and the brain.

Having identified the basic aspects of the learning rule in RL, we now turn to the biology.

Reinforcement Learning and the Brain:

Three-factor learning rules and 'brain-style' computing

Wulfram Gerstner

EPFL, Lausanne, Switzerland

Introduction

Coarse Brain Anatomy and Reinforcement Learning

Previous slide.

Before we can make a link to Reinforcement Learning we need to know a bit more about the brain.

1. Coarse Brain Anatomy and Reinforcement Learning

Reinforcement learning needs:

- states / sensory representation
 - where are states encoded in the brain?
- action selection
 - where is action selection encoded in the brain?
- reward signals
 - how is reward encoded in the brain?
 - is a 'TD-error' signal implemented in the brain?

Previous slide.

In reinforcement learning, the essential variables that define the update step of the learning rule are the states (defined by sensory representation), a policy for action selection, the actions themselves, and the rewards given by the environment.

If we want to link reinforcement learning to the brain, we will have to search for corresponding substrates and functions in the brain.

Therefore we now take a rather coarse and simplified look at the anatomy of the brain.

The Wikipedia articles give more information for those who are interested.

1. Coarse Brain Anatomy: Cortex

Sensory representation in visual/somatosensory/auditory cortex

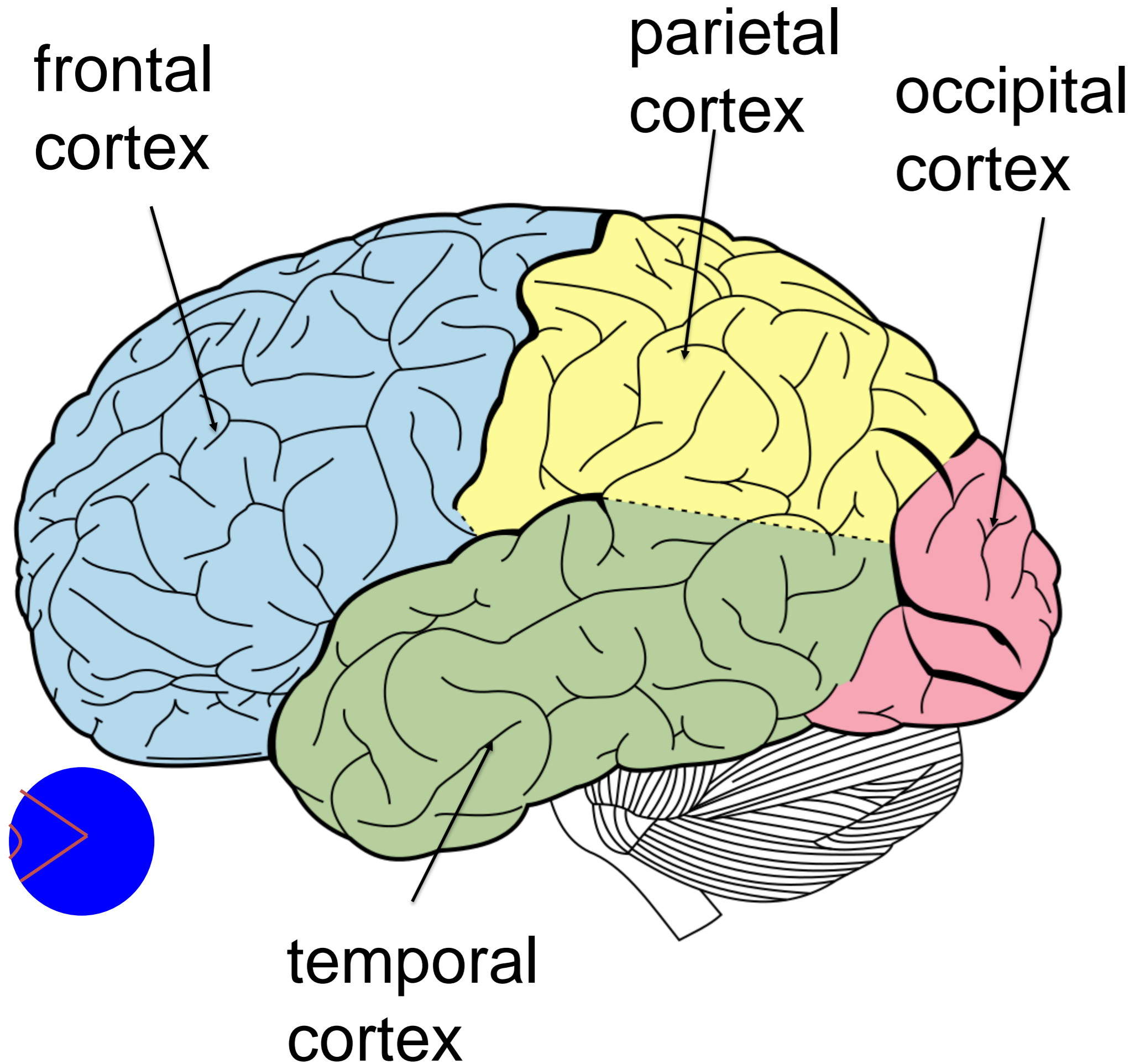

Motor and Sensory Regions of the Cerebral Cortex

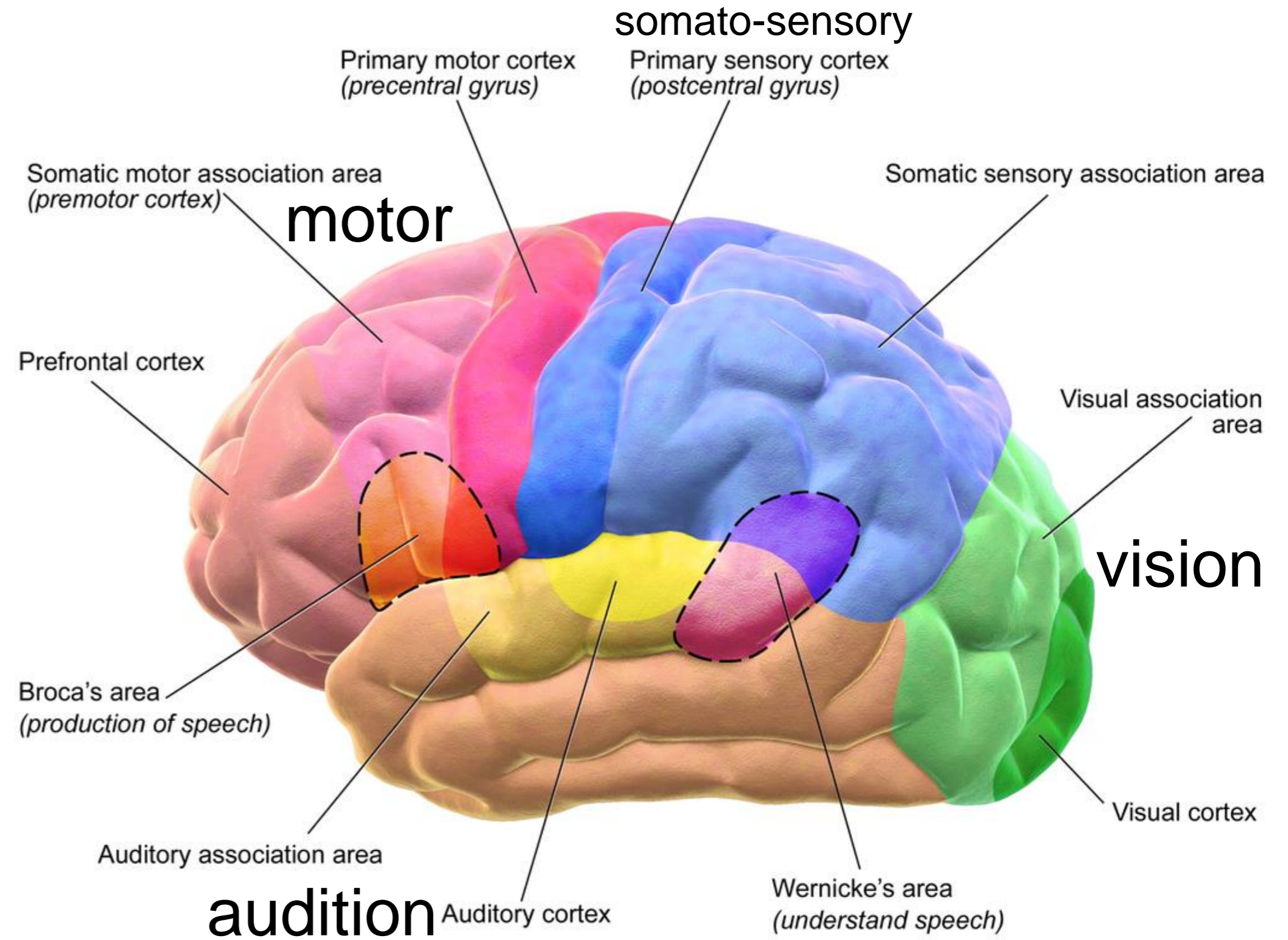

fig: Wikipedia

Previous slide.

Left: Anatomy. The Cortex is the part of the brain directly below the skull. It is a folded sheet of densely packed neurons. The biggest folds separate the four main parts of cortex (frontal, parietal, occipital, and temporal cortex)

Right: Functional assignments. Different parts of the brain are involved in different tasks. For example there several areas involved in processing visual stimuli (called primary and secondary visual cortex). Other areas are involved in audition (auditory cortex) or the presentation of the body surface (somatosensory cortex). Yet other areas are prepared in the preparation of motor commands for e.g., arm movement (primary motor cortex)

1. Coarse Brain Anatomy

- many different cortical areas
- but also several brain nuclei sitting below the cortex
- Some of these nuclei send dopamine signals
- Dopamine sent from: VTA and substantia nigra
- **Dopamine is related to reward, surprise, and pleasure**

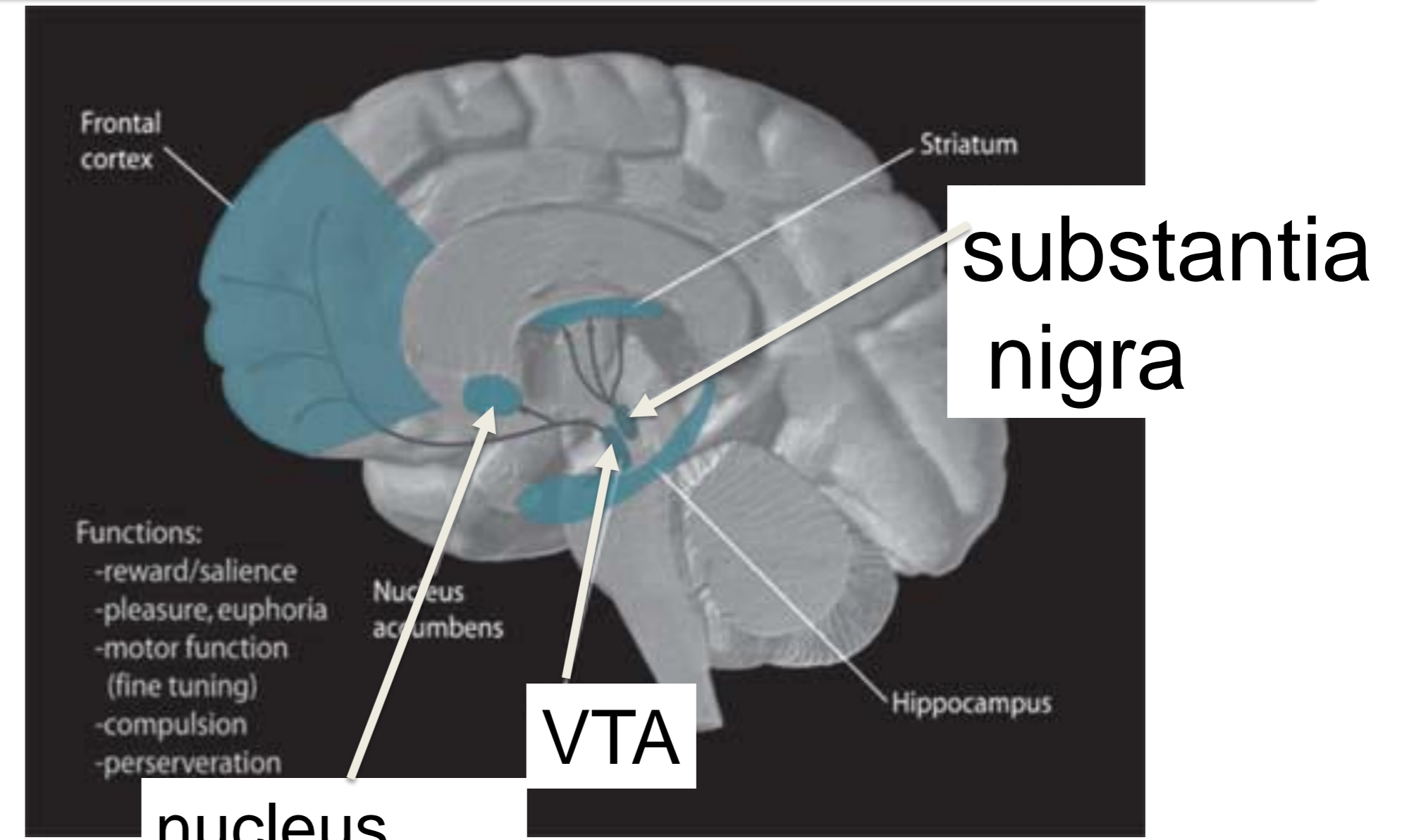
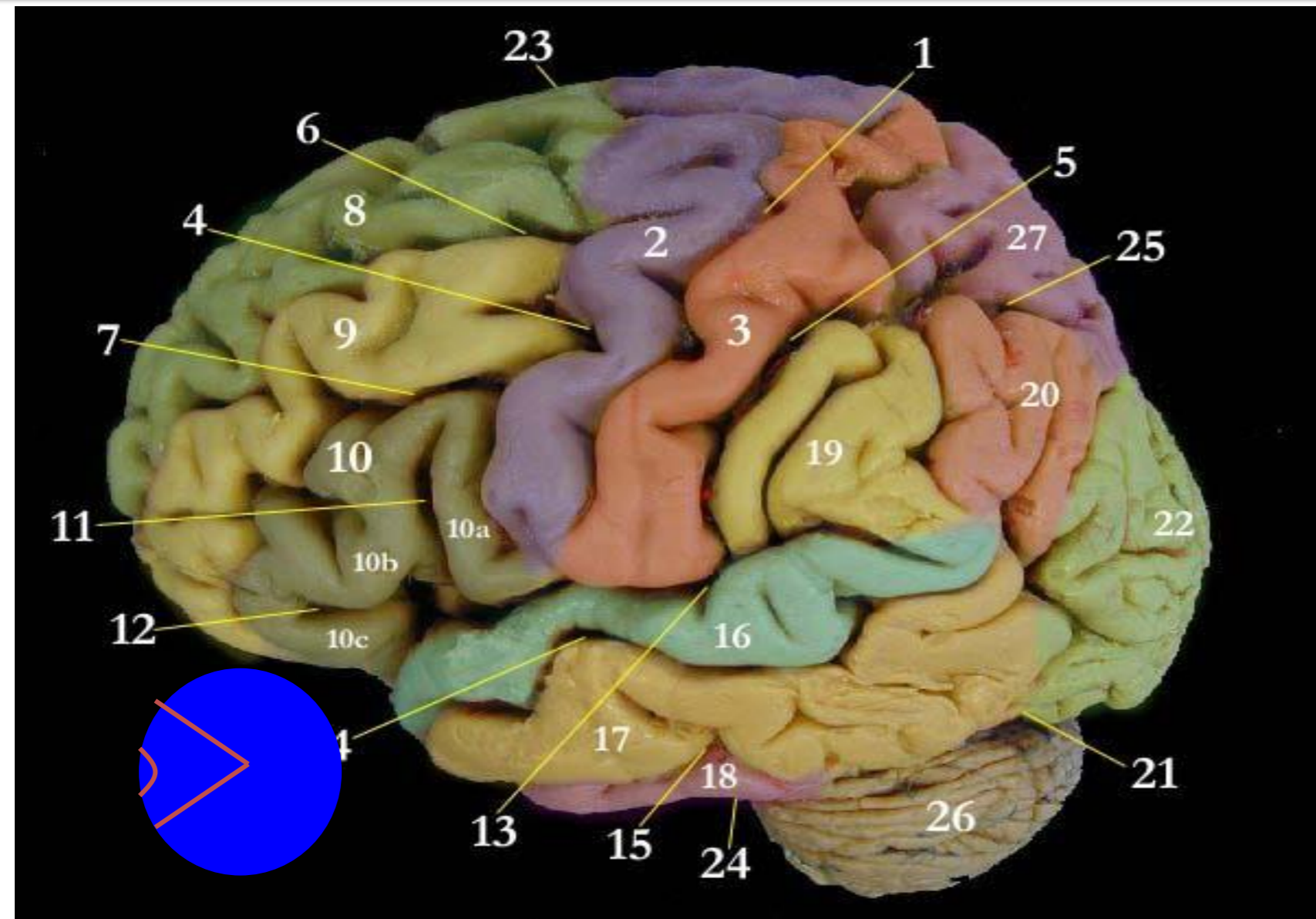

nucleus

accumbens

fig: Wikipedia commons

Previous slide.

Left: Anatomy. View on the folds of the cortex, and main cortical areas in different color.

Right: Below the cortex sit different nuclei. Some of these nuclei use dopamine as their signaling molecule. Important nuclei for dopamine are the Ventral Tegmental Area (VTA) and the Substantia Nigra pars compacte (SNc). These dopamine neurons send their signals to large areas of the cortex as well as to the striatum (and nucleus accumbens).

Since dopamine is involved in reward, these dopamine neurons will play a role in this lecture that links reinforcement learning and the brain.

Frontal Cortex is also involved in many aspects related to Reinforcement Learning.

In the next slides we will focus on striatum and hippocampus.

1. Coarse Brain Anatomy: Striatum

- Striatum sits below cortex
- Part of the 'basal ganglia'
- **Dorsal striatum involved in action selection, decisions**

- Striatum consists of
- Caudate (dorsal striatum)
 - Putamen (dorsal striatum)

<https://en.wikipedia.org/wiki/Striatum>

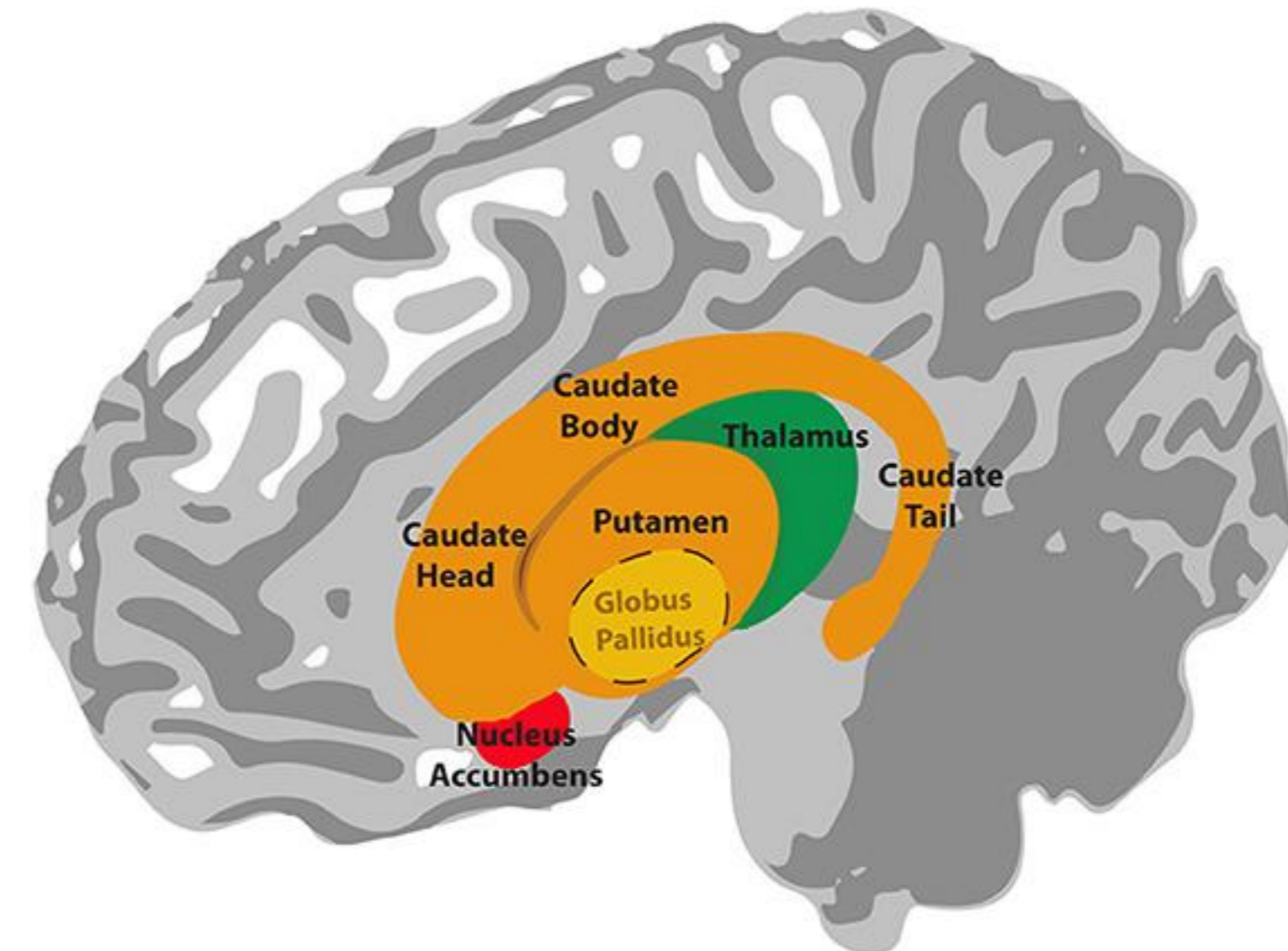
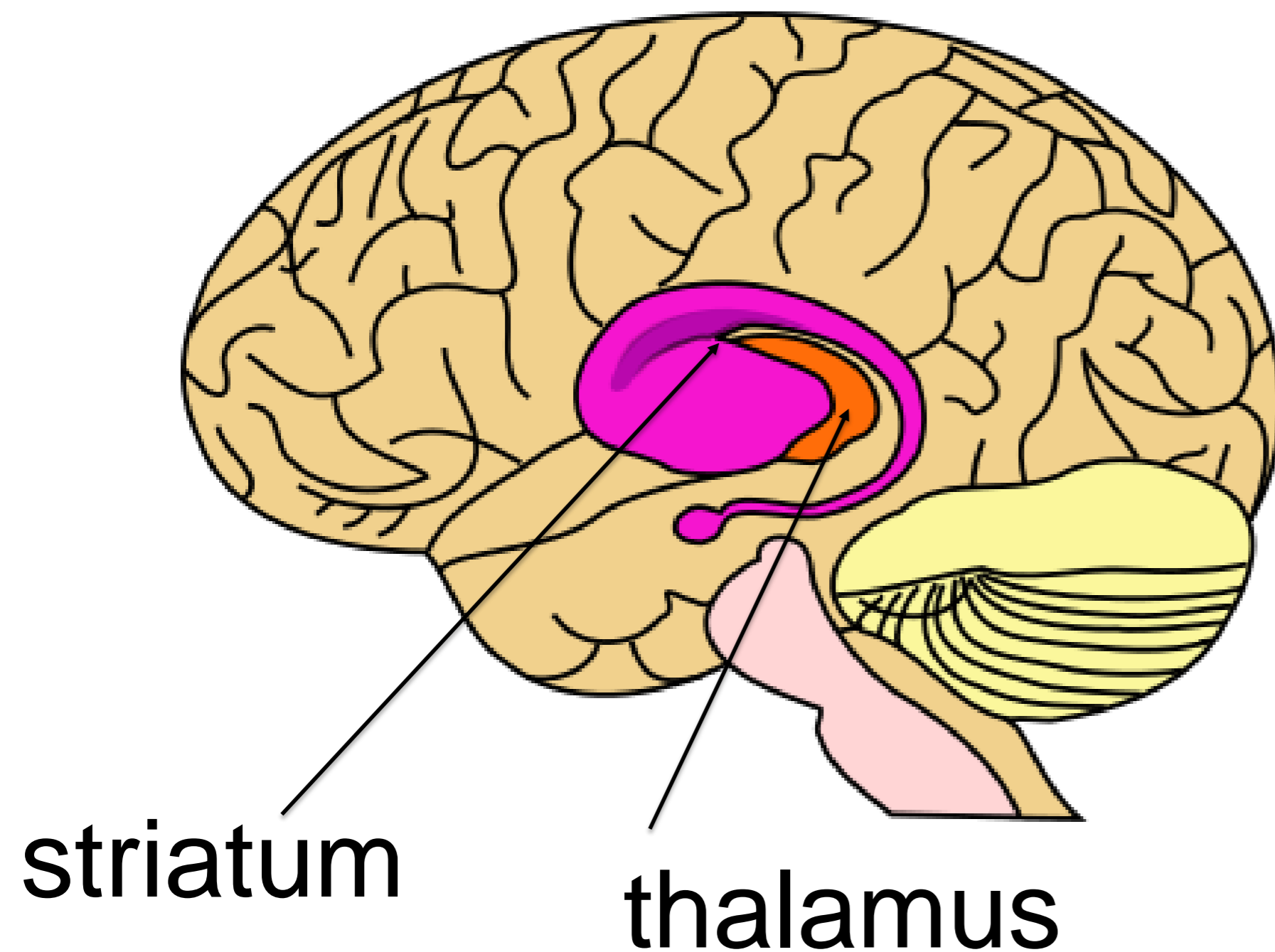

Nucleus Accumbens is part of ventral striatum

fig: Wikipedia

Previous slide.

Left: Sketch of the Anatomical location of striatum and thalamus.

Right: the striatum lies also below the cortex. Since the striatum is involved in action selection it will play an important role in this lecture.

From Wikipedia:

The **striatum** is a [nucleus](#) (a cluster of [neurons](#)) in the [subcortical basal ganglia](#) of the [forebrain](#). The striatum is a critical component of the [motor](#) and [reward](#) systems; receives [glutamatergic](#) and [dopaminergic](#) inputs from different sources; and serves as the primary input to the rest of the basal ganglia.

Functionally, the striatum coordinates multiple aspects of [cognition](#), including both motor and action [planning](#), [decision-making](#), [motivation](#), [reinforcement](#), and [reward](#) perception. The striatum is made up of the [caudate nucleus](#) and the [lentiform nucleus](#). The lentiform nucleus is made up of the larger [putamen](#), and the smaller [globus pallidus](#).

In [primates](#), the striatum is divided into a **ventral striatum**, and a **dorsal striatum**, subdivisions that are based upon function and connections. The [ventral](#) striatum consists of the [nucleus accumbens](#) and the [olfactory tubercle](#). The [dorsal](#) striatum consists of the [caudate nucleus](#) and the [putamen](#). A [white matter, nerve tract](#) (the [internal capsule](#)) in the dorsal striatum separates the [caudate nucleus](#) and the [putamen](#).^[4] Anatomically, the term *striatum* describes its striped (striated) appearance of grey-and-white matter

1. Coarse Brain Anatomy: hippocampus

[Henry Gray](#) (1918) *Anatomy of the Human Body*

fig: Wikipedia

Hippocampus

- sits below/part of temporal cortex
- involved in memory
- involved in **spatial** memory

Spatial memory:

knowing where you are,
knowing how to navigate in an environment

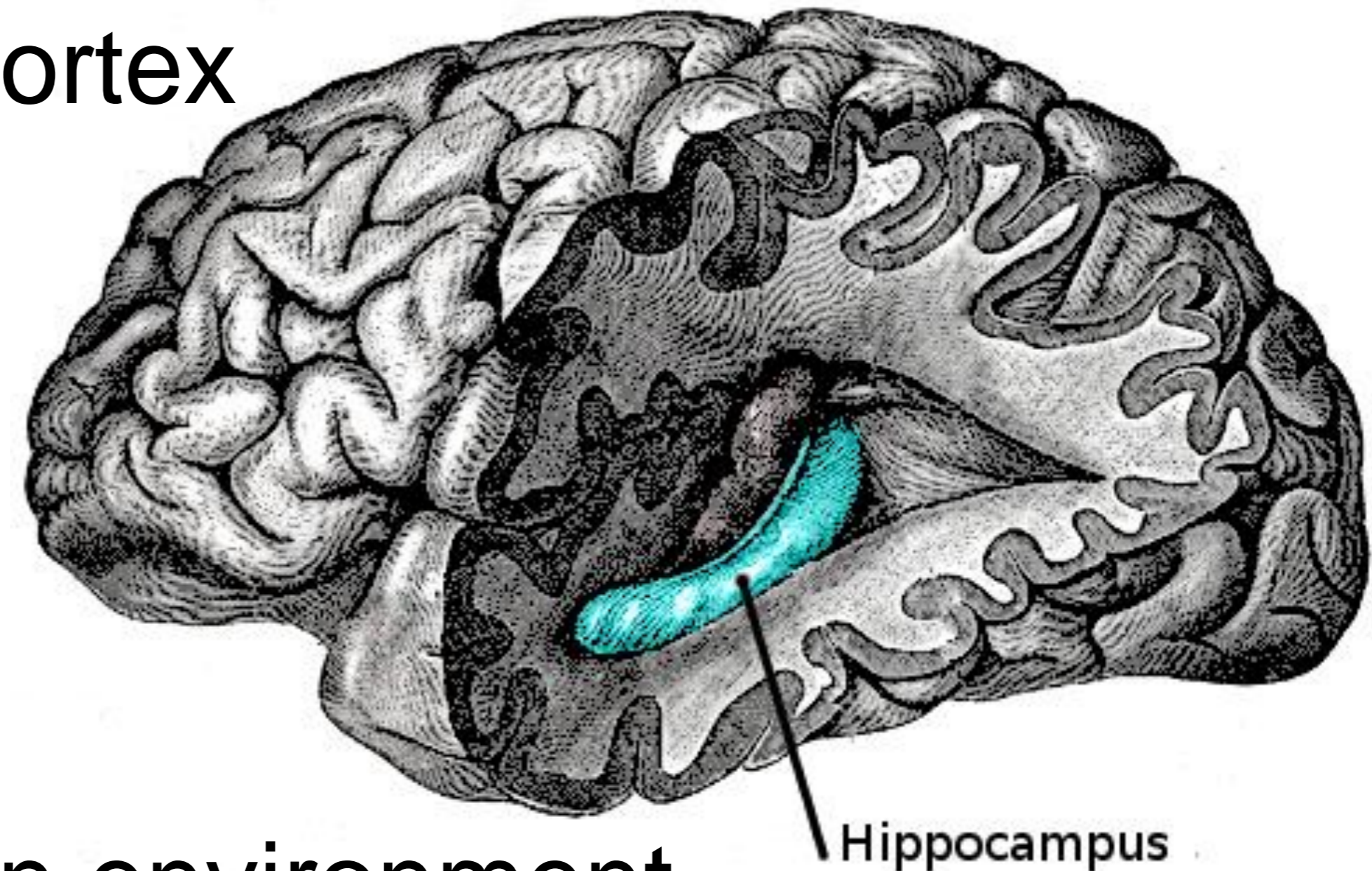

Hippocampus involved in spatial memory
→ 'state representation'

Previous slide.

From Wikipedia:

The **hippocampus** (named after its resemblance to the [seahorse](#), from the [Greek](#) ἵππόκαμπος, "seahorse" from ἵππος *hippos*, "horse" and κάμπος *kampos*, "sea monster") is a major component of the [brains](#) of [humans](#) and other [vertebrates](#). Humans and other mammals have two hippocampuses, one in each [side of the brain](#). The hippocampus belongs to the [limbic system](#) and plays important roles in the consolidation of information from [short-term memory](#) to [long-term memory](#), and in [spatial memory](#) that enables navigation. The hippocampus is located under the [cerebral cortex](#) ([allocortical](#))^{[1][2][3]} and in primates in the [medial temporal lobe](#).

1. Coarse brain anatomy: the brain adapts during use

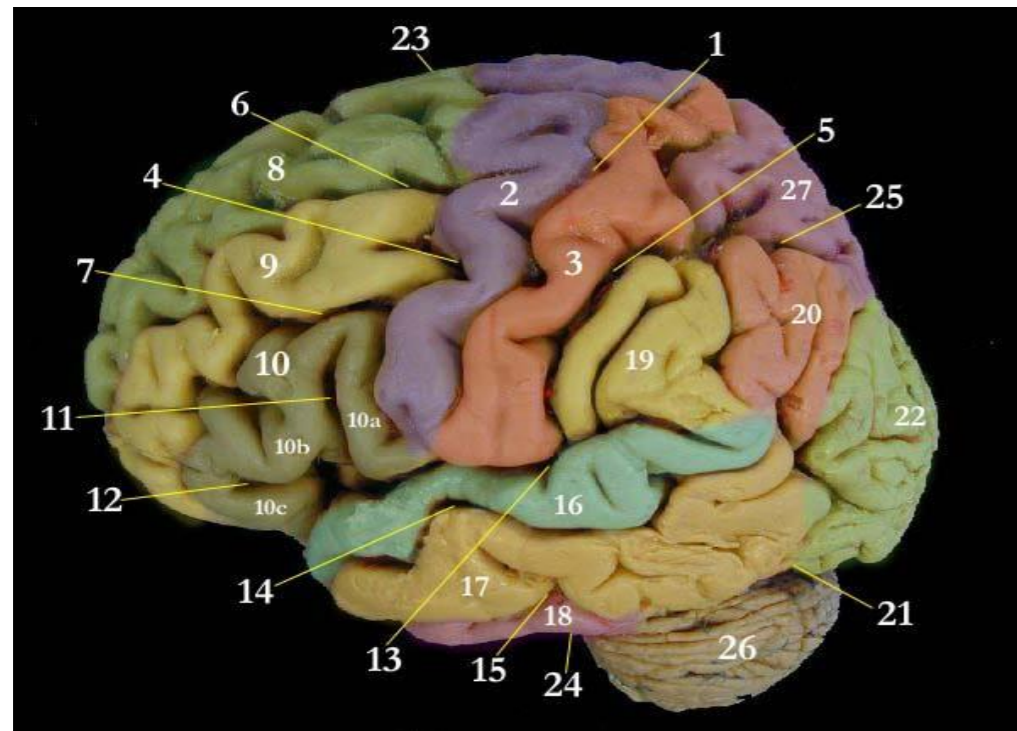

More space for fingers allocated in somato-sensory cortex (=body representation; number 3 on image)
- musicians vs. non-musicians

Amunts et al. Human Brain Map. 1997
Gaser and Schlaug, J. Neurosci. 2003

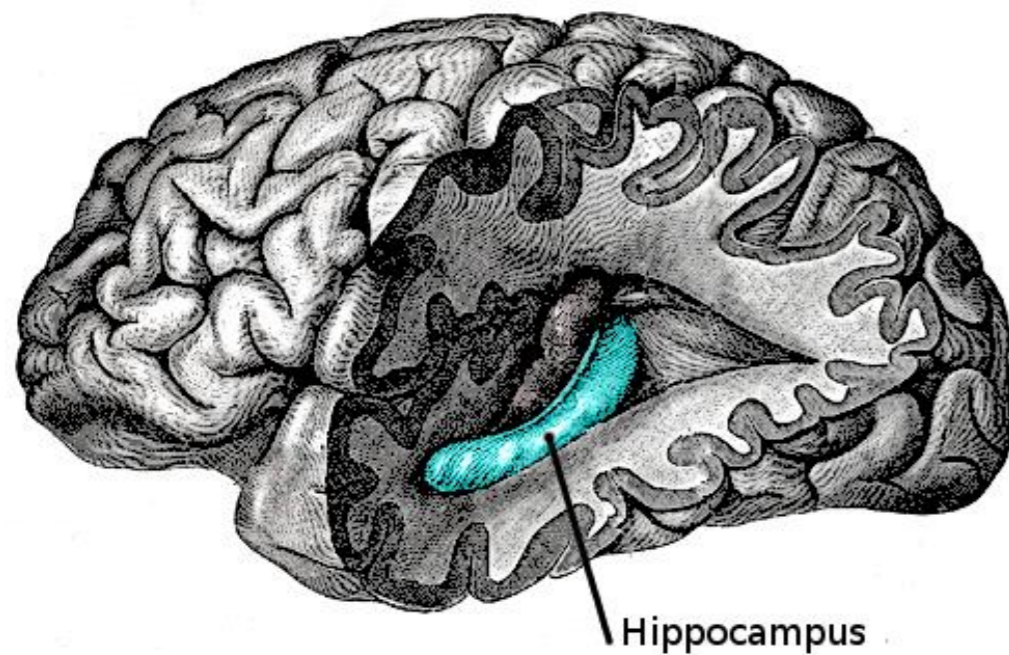

More space allocated in hippocampus (= representation of space; blue on image)
- London taxi driver vs bus driver

Macquire et al. Hippocampus 2006

DOI 10.1002/hipo.2023

→ 'state representation' is 'learned'

Previous slide.

https://en.wikipedia.org/wiki/Primary_somatosensory_cortex#/media/File:Blausen_0103_Brain_Sensory&Motor.png

We said that different areas of the brain are involved in different tasks. For example, the somatosensory cortex represents the body surface. Nowadays one can measure that the size of the cortical area devoted to fingers is larger for musicians than for non-musicians. Since musicians are not born with a larger area, this result implies that experience can influence the function of the neurons in the brain. Somatosensory cortex is labeled 3 (previous page). The actual movements of fingers and other body parts are controlled by motor cortex (label 2).

Similarly, hippocampus is involved in spatial navigation. Not surprisingly, London taxi drivers have a bigger hippocampus than London bus drivers.

Image from
wikipedia

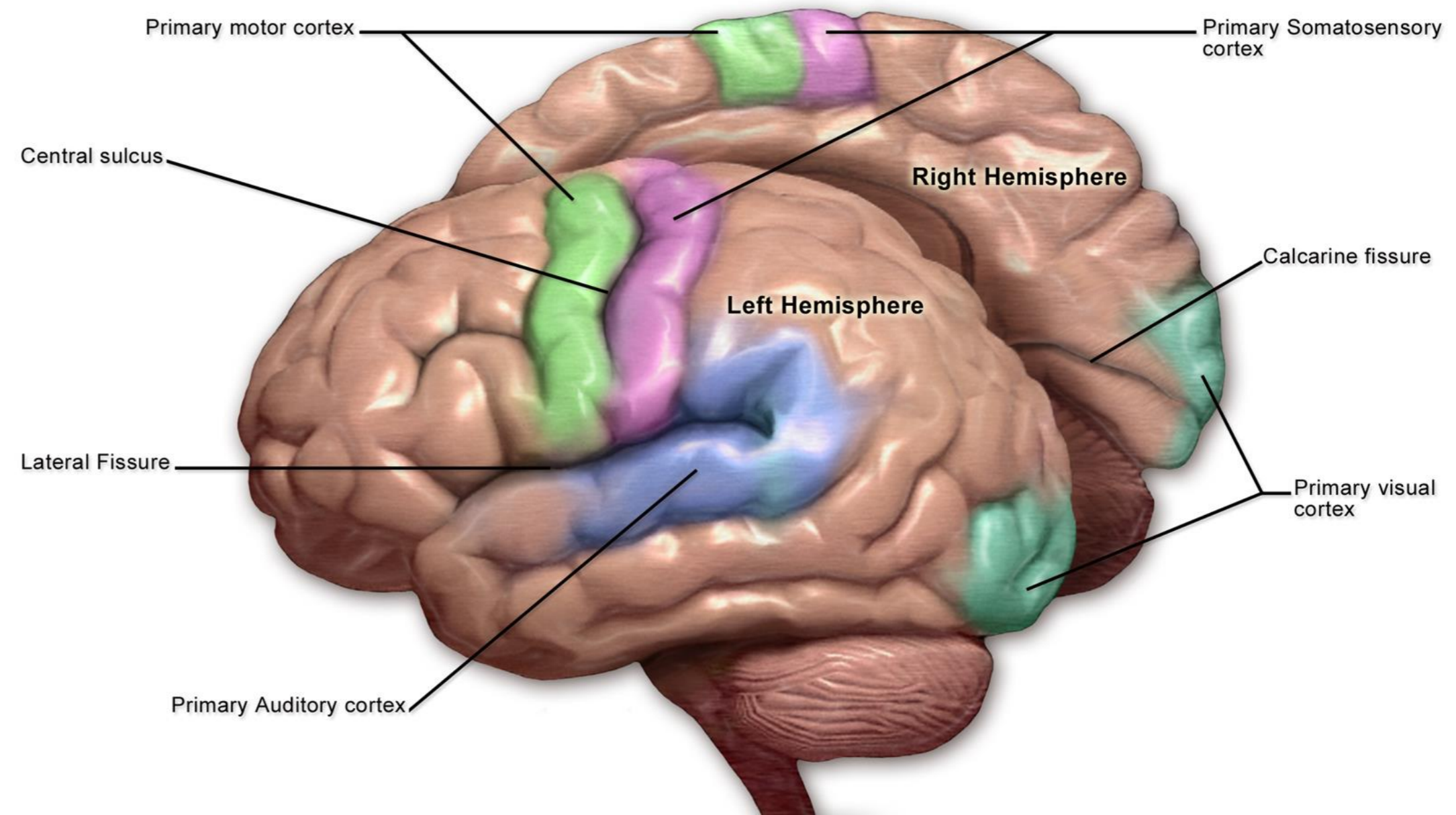

1. Coarse Brain Anatomy and Reinforcement Learning

Reinforcement learning needs:

- representation of states / sensory input / 'where'
→ hippocampus? / sensory cortex?
- action selection → striatum?, motor cortex?
- reward signals → dopamine?

→ Candidate brain areas and brain signals!

Previous slide.

In reinforcement learning, the essential variables are the states (defined by sensory representation), a policy for action selection, the actions themselves, and the rewards given by the environment.

If we want to link reinforcement learning to the brain, we will have to search for corresponding substrates and functions in the brain.

The potential relations show candidate brain region for a mapping to state, actions, and reward. The above rough ideas need to be defined during the rest of this lecture.

1. Quiz: Coarse Functional Brain anatomy

- the brain = the cortex (synonyms)
- the cortex consists of several areas
- some areas are more involved in vision, others more in the representation of the body surface
- below the cortex there are groups (clusters) of neurons
- Hippocampus sends out dopamine signals
- VTA sends out dopamine signals

- dopamine is linked to reward, pleasure, surprise
- striatum is involved in action selection
- hippocampus is involved in the representation of 'WHERE'

Previous slide. Your comments

Reinforcement Learning and the Brain:

Three-factor learning rules and 'brain-style' computing

1. Coarse Brain Anatomy

2. **Synaptic Plasticity**

- basis of 'learning rules' in the brain

- Hebbian Learning and Long-Term Potentiation (LTP)

synapse: connection point between two neurons

presynaptic neuron: sending neuron

postsynaptic neuron: receiving neuron

Previous slide.

Reinforcement Learning is, obviously, a form of 'learning'.

Learning is related to synaptic plasticity. Therefore this is our second topic.

The claim is that the biological observation of 'synaptic plasticity' is the basis of 'learning rules' implemented in the brain.

Two important manifestations of synaptic plasticity are Hebbian Learning and Long-Term Potentiation (LTP) that will be explained in this part.

2. Behavioral Learning

Learning actions (reward-based):

- riding a bicycle
- play tennis
- play the violin

‘models of action choice’

Remembering episodes

- first day at EPFL
- first visit in a new city
- reward-free

‘models of the world’

Previous slide.

When we learn to ride a bike we learn with Reinforcement-like feedback, e.g., we don't want to fall because falling hurts.

When we learn play the tennis we also get feedback via the observed outcome – which can be good or bad.

When we walk around a city for the first time we develop a model of the environment – even in the absence of any specific rewards (except, may be, that it is good to know how to find the way home).

All these are examples of learning. Remembering episodes is mainly unsupervised learning, but the others are clearly reinforcement learning.

2. Behavioral Learning – and synaptic plasticity

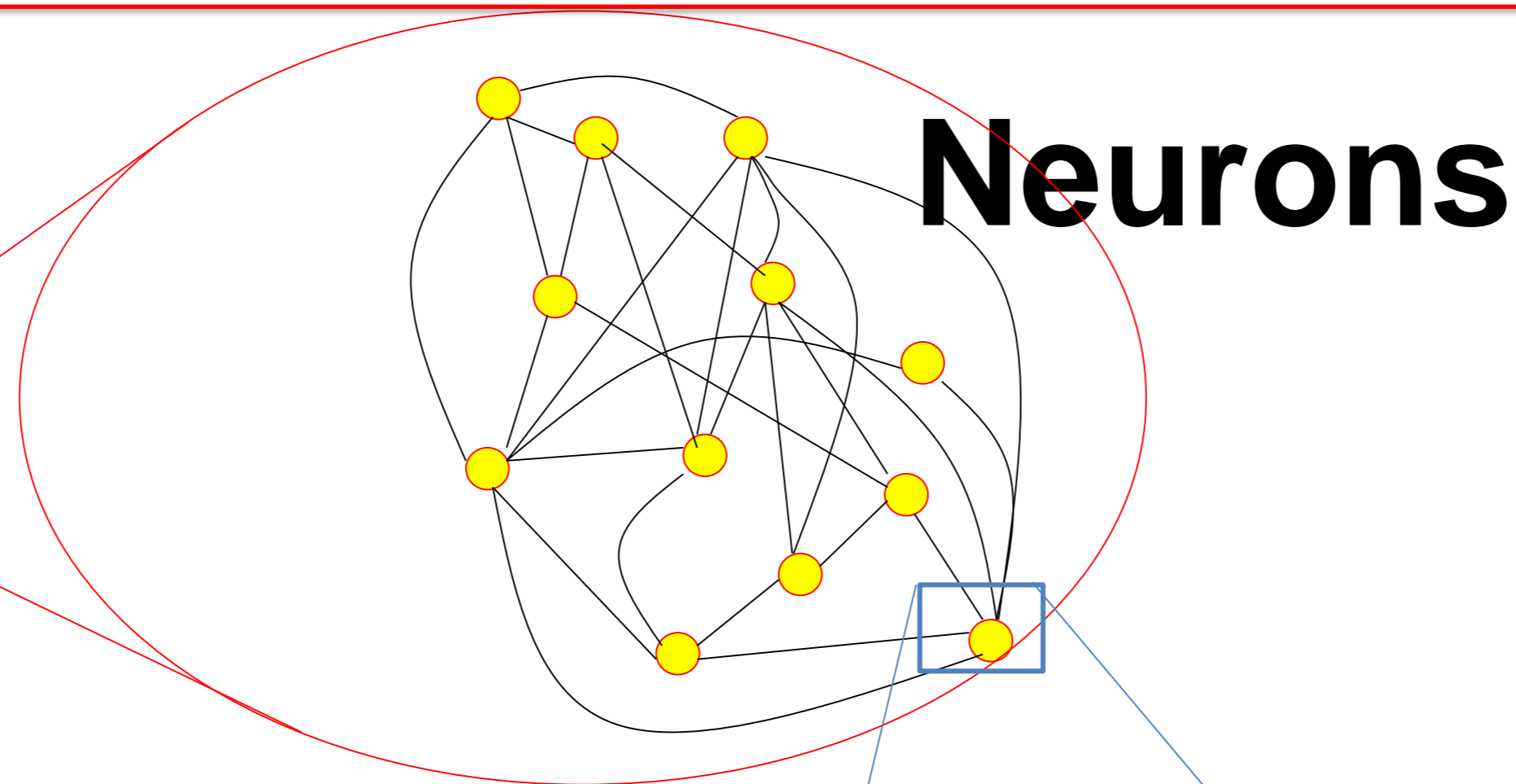
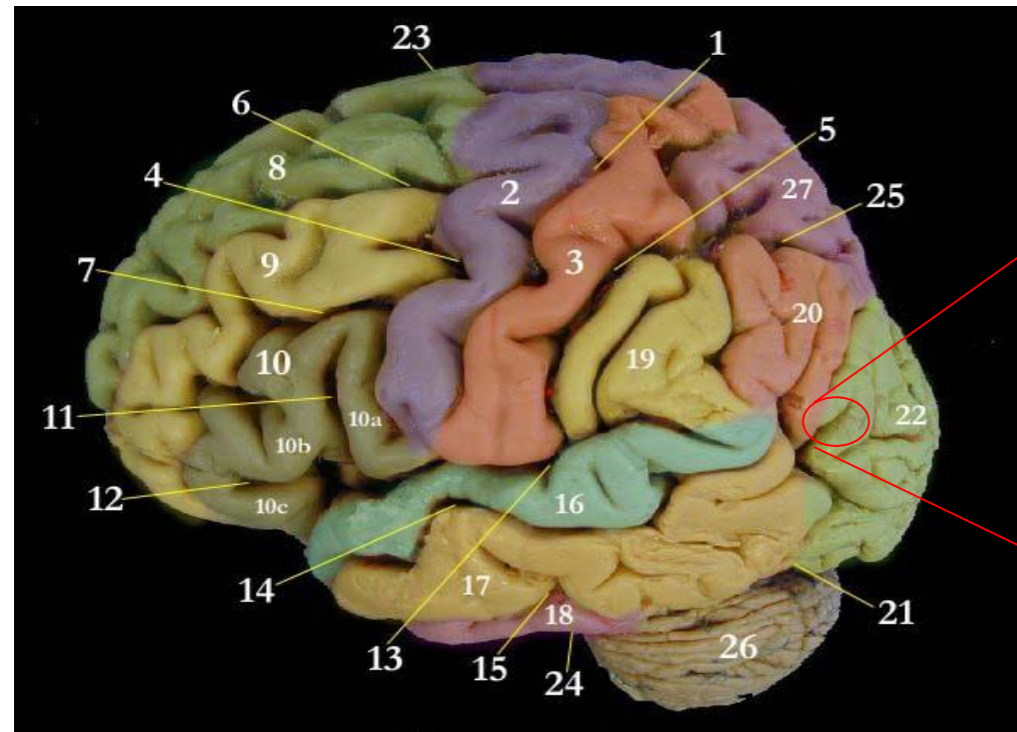

Amplitude of Postsynaptic Potential (PSP)

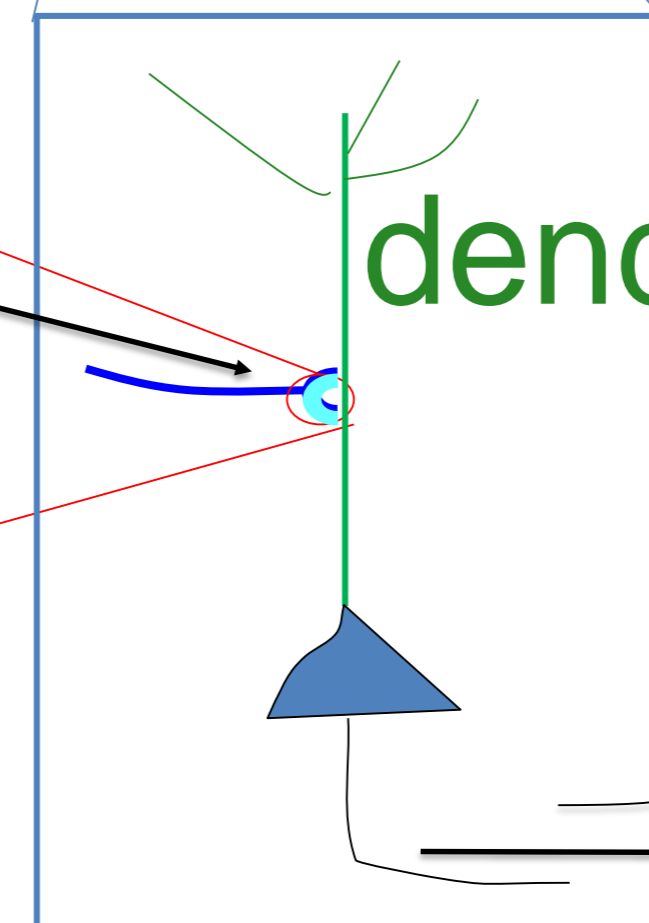
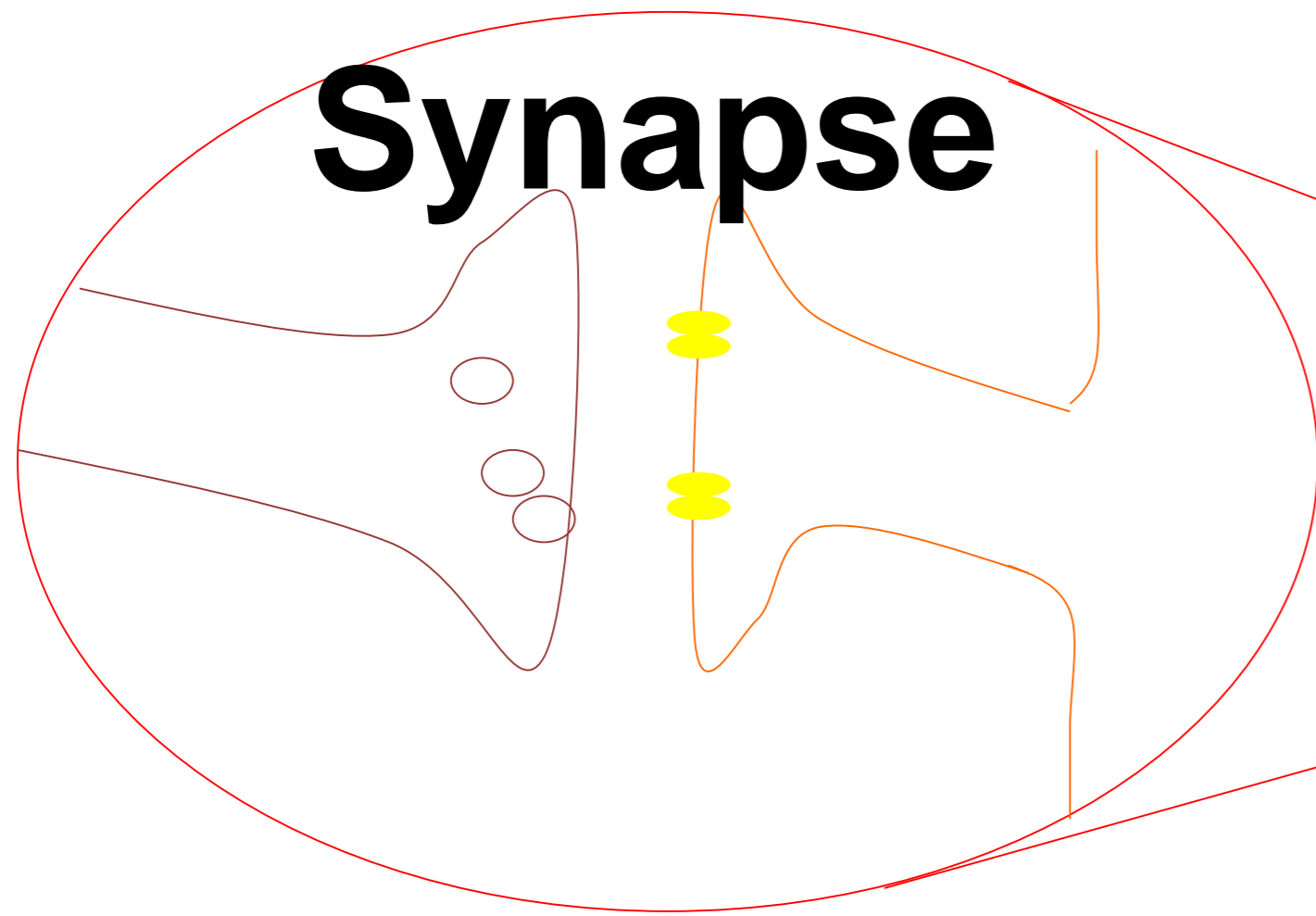
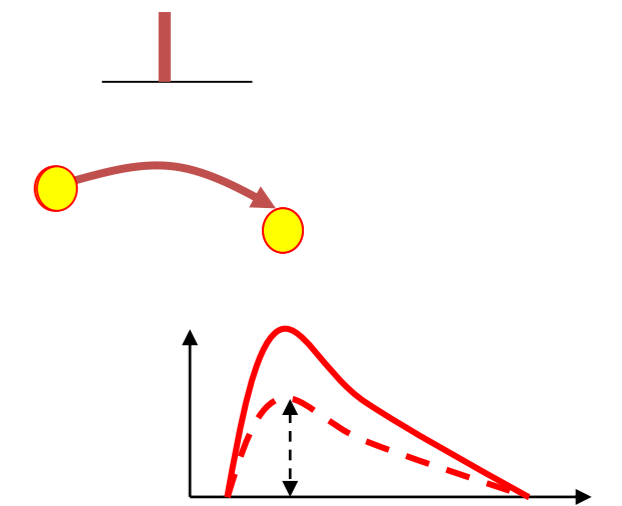

'spike':
output signal (pulse)
sent to other neurons

Synaptic Plasticity = Change in Connection Strength

Previous slide.

When we observe learning on the level of behavior (we get better at tennis), then this implies that something has changed in our brain:

The contact points between neurons (called synapses) have changed. Synaptic changes manifest themselves as a change in connections strength.

Synaptic plasticity describes the phenomena and rules of synaptic changes.

The connection strength can be measured by the

- amplitude of the postsynaptic potential (PSP)
- by physical size of the synapse (in particular the spine, see next slide)

Important:

Neurons communicate with each other by short electrical pulses, often called 'spikes'.

2. Synaptic plasticity – structural changes

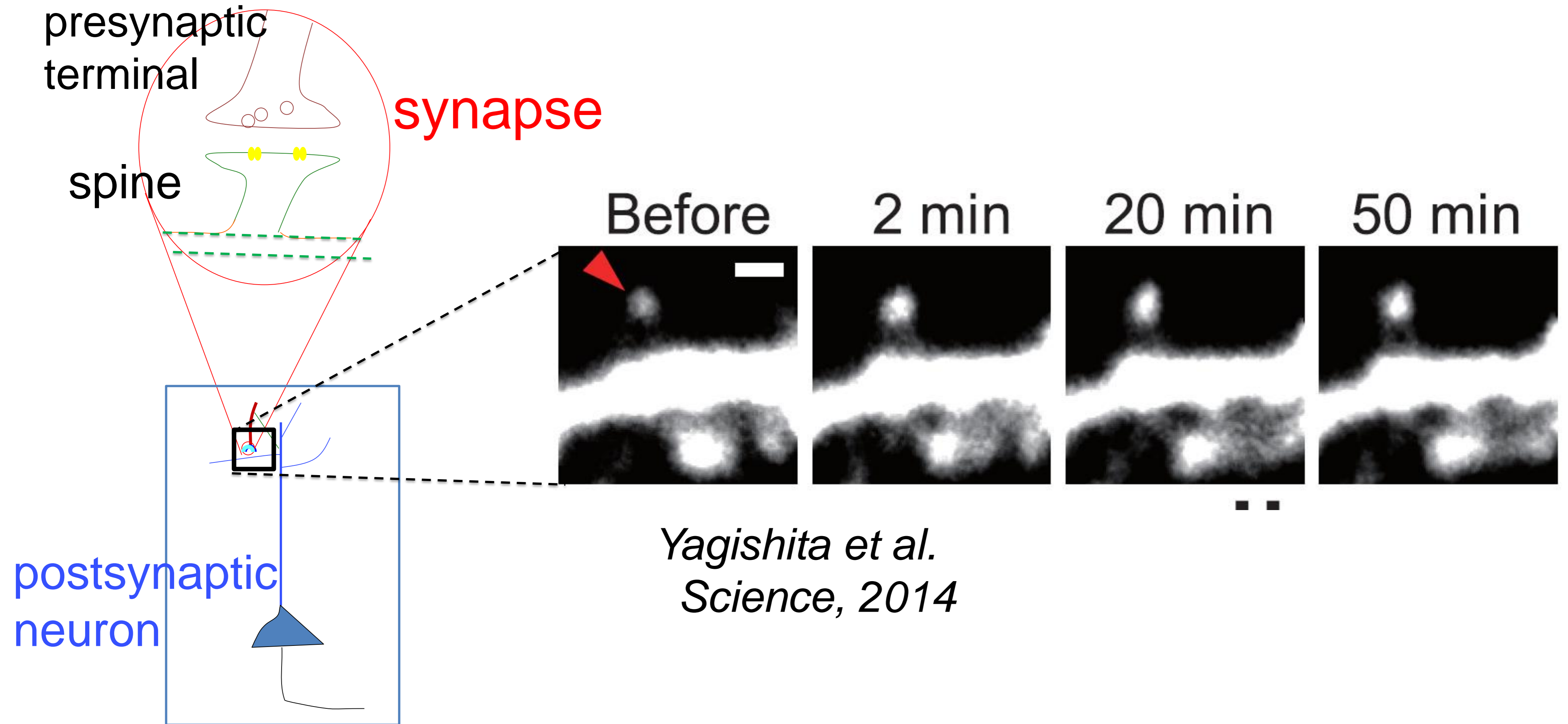

Previous slide.

The synaptic connection consists of two parts. The end of an axonal branch coming from the sending neuron; and the counterpart, a protrusion on the dendrite of the receiving neuron, called spine.

We refer to the sending neuron as presynaptic and to the receiving one as postsynaptic.

A change in the connection strength is observable with imaging methods as an increase in the size of the spine. The bigger spine remains big for a long time (here observed for nearly one hour).

2. Synaptic plasticity: summary

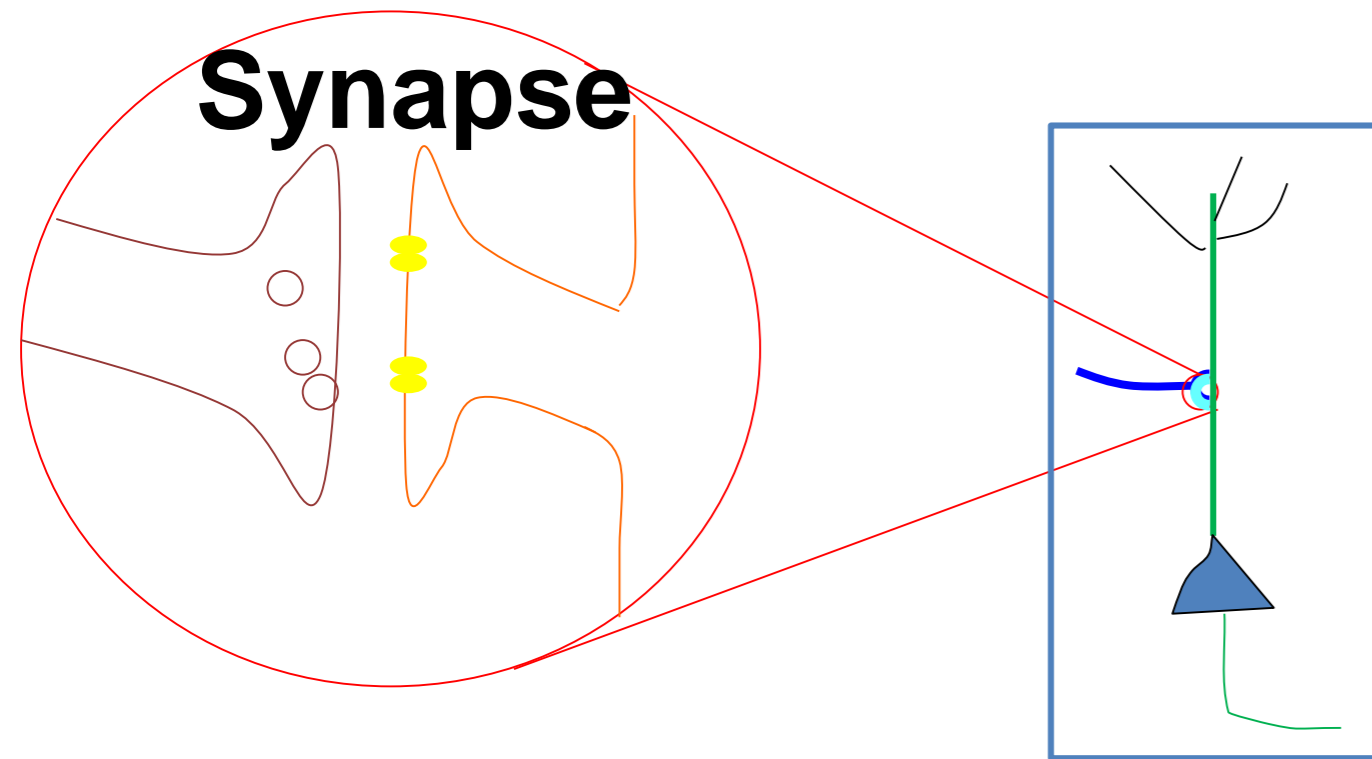

- Connections can be strong or weak
- Strong connections have thick spines
- Synaptic plasticity
= change of connection

Syn. Plasticity should enable Learning

- memorize facts and episodes
- learn to recognize WHERE we are
→ current state
- learn models of the world
→ predict the near future
- learn appropriate actions

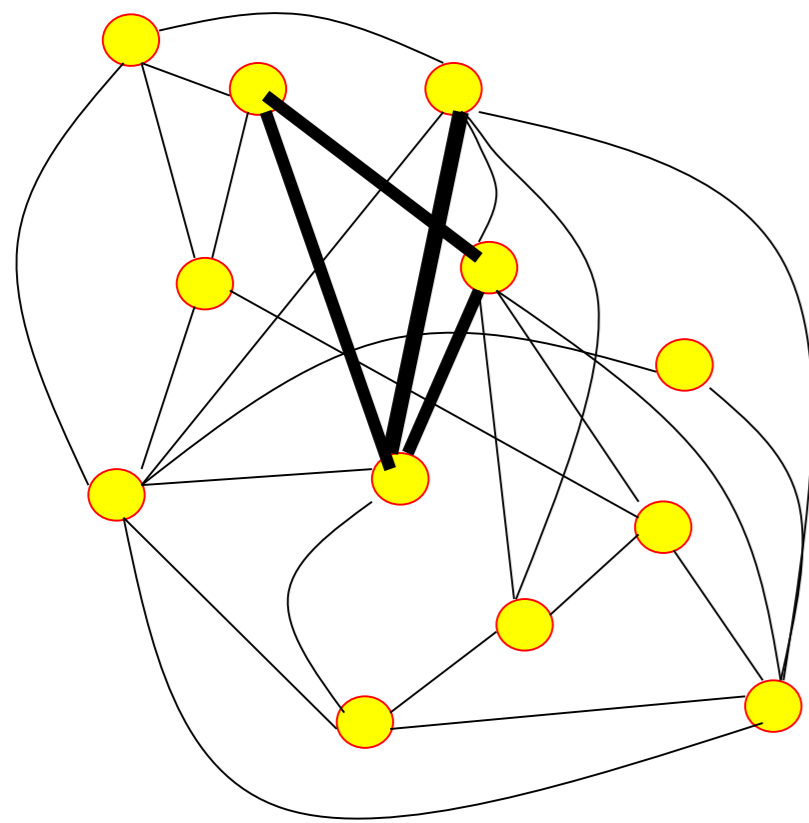

Previous slide.

Thus connections can be strong or weak – and synaptic plasticity describes the changes of one synapse from weak to strong or back.

The synaptic changes are thought to be the basis of learning – whatever the learning task at hand. And RL has several aspects of learning:

- learn to recognize states = where we are;
- learn to choose good actions = action selection;
- learn to predict possible next states = model-based reinforcement learning.

The question now is: Are there any 'rules' for connection changes that would predict whether and when a synapse gets stronger?

2. Hebb rule / Hebbian Learning

presynaptic neuron

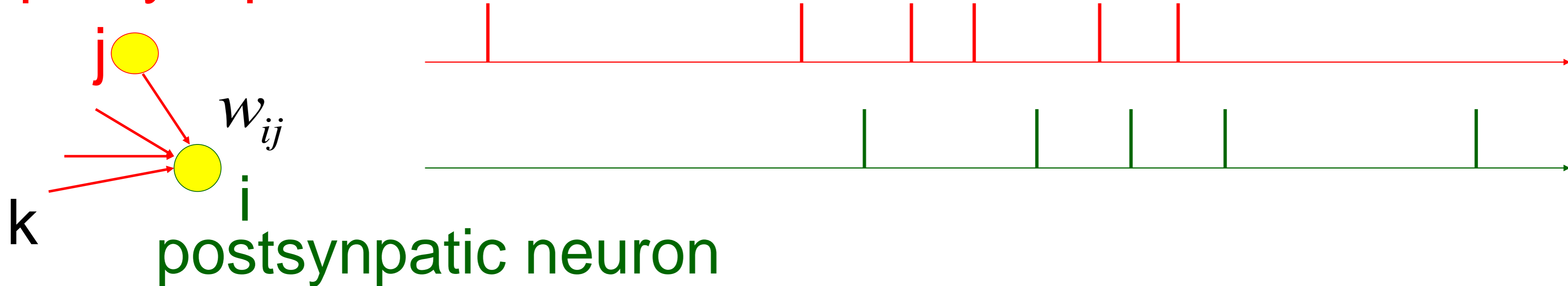

When an axon of cell **j** repeatedly or persistently takes part in firing cell **i**, then **j**'s efficiency as one of the cells firing **i** is increased

Hebb, 1949

- local rule
- simultaneously active (correlations)

Previous slide.

The Hebb rule is the classic rule of synaptic plasticity.

It is often summarized by saying: if two neurons are active together, the connection between those two neurons gets stronger.

Note that the original formulation of Hebb also has a 'causal' notion: 'takes part in firing' – which is more than just firing together.

Local rule means: changes only depend on information that is available at the synapse.

The changes for the weight from j to i can depend on the activity of neuron j and the state (or activity) of neuron i , and the value of the weight itself, but for example not explicitly on the activity of another neuron k . Note that if k connects to i , the activity of i is a good summary of the influence of k . In other words, i may depend **IMPLICITLY** on k , but the weight changes do not depend **EXPLICITLY** on k .

Quiz. Terms used Synaptic Plasticity and Learning

We look at the specific synapse w_{ij}

k is called the presynaptic neuron of the synapse w_{ij}

k is called a presynaptic neuron of i

j is called the presynaptic neuron of this synapse

i is called the postsynaptic neuron of this synapse

the strength of a synapse can be measured by the PSP amplitude.

PSP means presynaptic potential

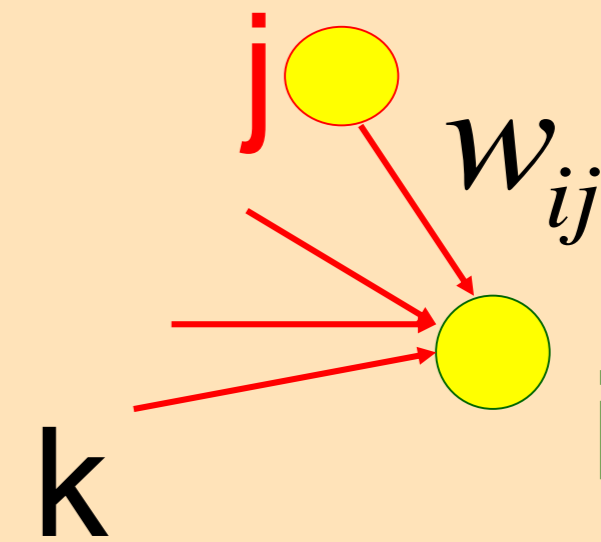

Learning rules in the brain

Hebbian learning depends on presynaptic activity AND on state of postsynaptic neuron

A learning rule is called local, if it uses only information available at the location of the synapse.

Neurons communicate by sequences of spikes

Previous slide.

1. The neuron BEFORE the synapse is called the **presynaptic neurons:**
it sends spike to the synapse.
2. The neuron AFTER the synapse is called the **postsynaptic neurons:**
it receives a signal via the synapse.
3. Hebbian learning: the joint activation of pre- and postsynaptic neuron induces a strengthening of the synapses.
4. A learning rule is called local, if it uses only information available at the location of the synapse.

2. Hebbian Learning (LTP)

Hebbian coactivation:
pre-post-post-post

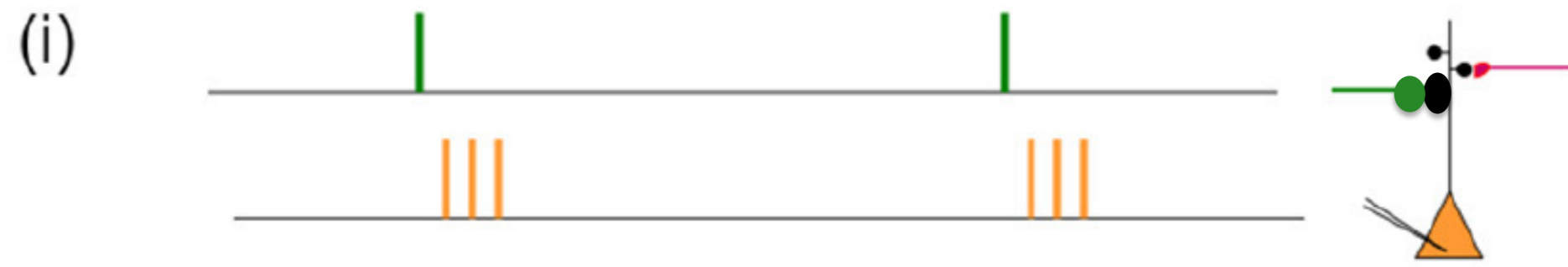

“if two neurons are active together, the connection between those two neurons gets stronger.”

“another synapse (red) which does not receive presynaptic spikes, does NOT increase”

Previous slide.

The joint activation of pre- and postsynaptic neuron induces a strengthening of the synapses. A strong stimulus is several repetitions of a pulse of the presynaptic neuron, followed by three or four spikes of the postsynaptic neuron.

Hundreds of experiments are consistent with Hebbian learning.

Note that by definition of Hebbian learning, only the stimulated synapses (green) is strengthened, but not another synapses (red) onto the same neuron.

2. Synaptic plasticity: Long-Term Potentiation (LTP)

Hebbian Learning in experiments (schematic)

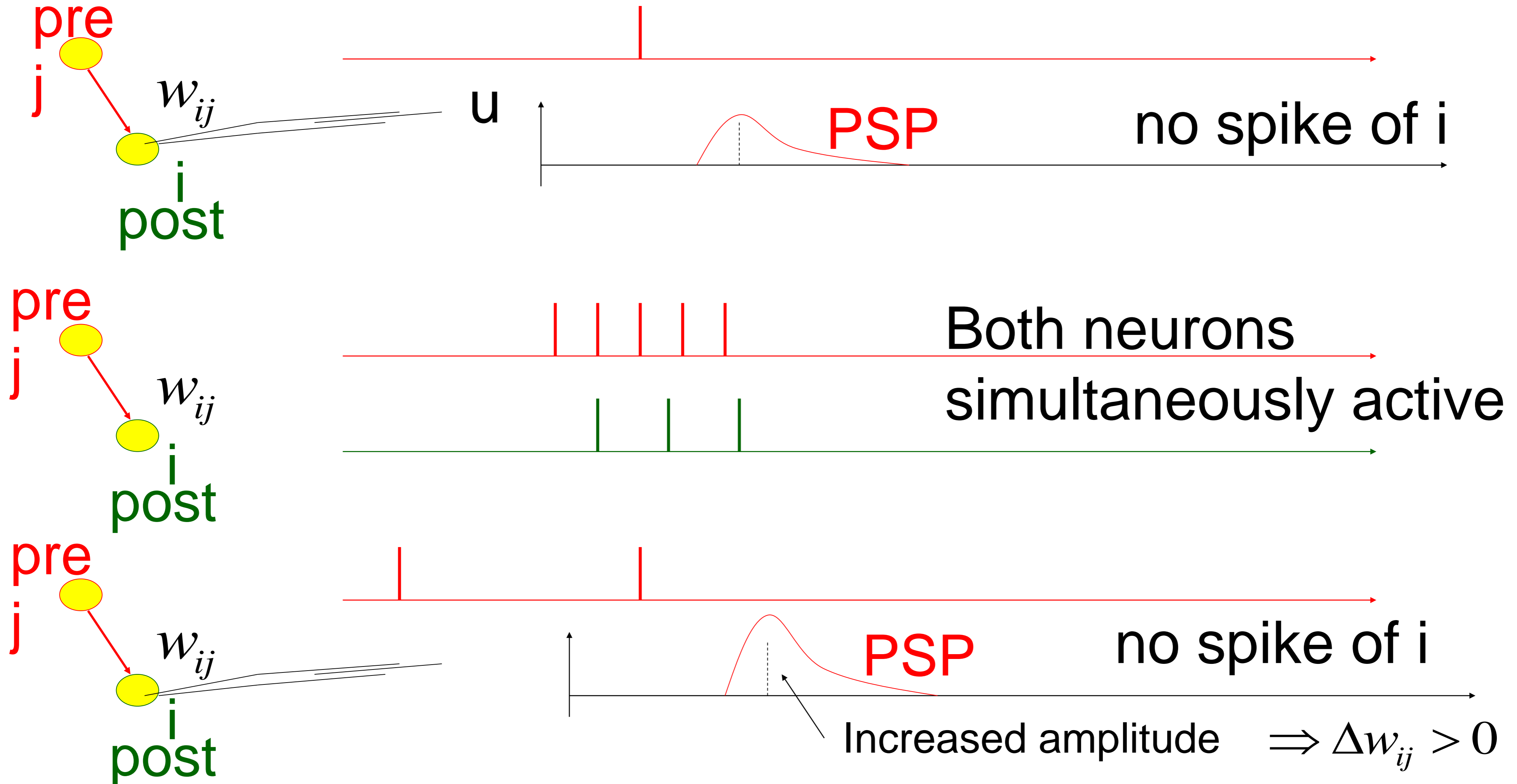

Previous slide.

In a schematic experiment,

- 1) You first test the size of the synapse by sending a pulse from the presynaptic neurons across the synapses. The amplitude of the excitatory postsynaptic potential (EPSP) is a convenient measure of the synaptic strength. It has been shown that it is correlated with the size of the spine.
- 2) Then you do the Hebbian protocol: you make both neurons fire together
- 3) Finally you test again the size of the synapse. If the amplitude is bigger you conclude that the synaptic weight has increased.

2. Why the name 'Long-term plasticity' (LTP)?

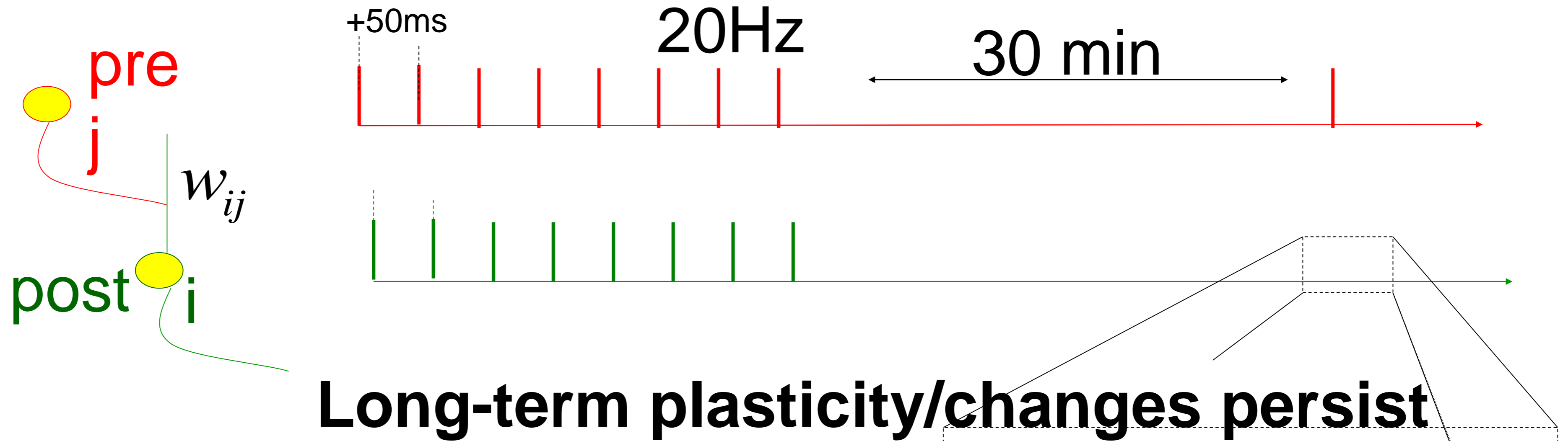

Changes

- induced over 3 sec
- persist over 1 – 10 hours (or longer?)

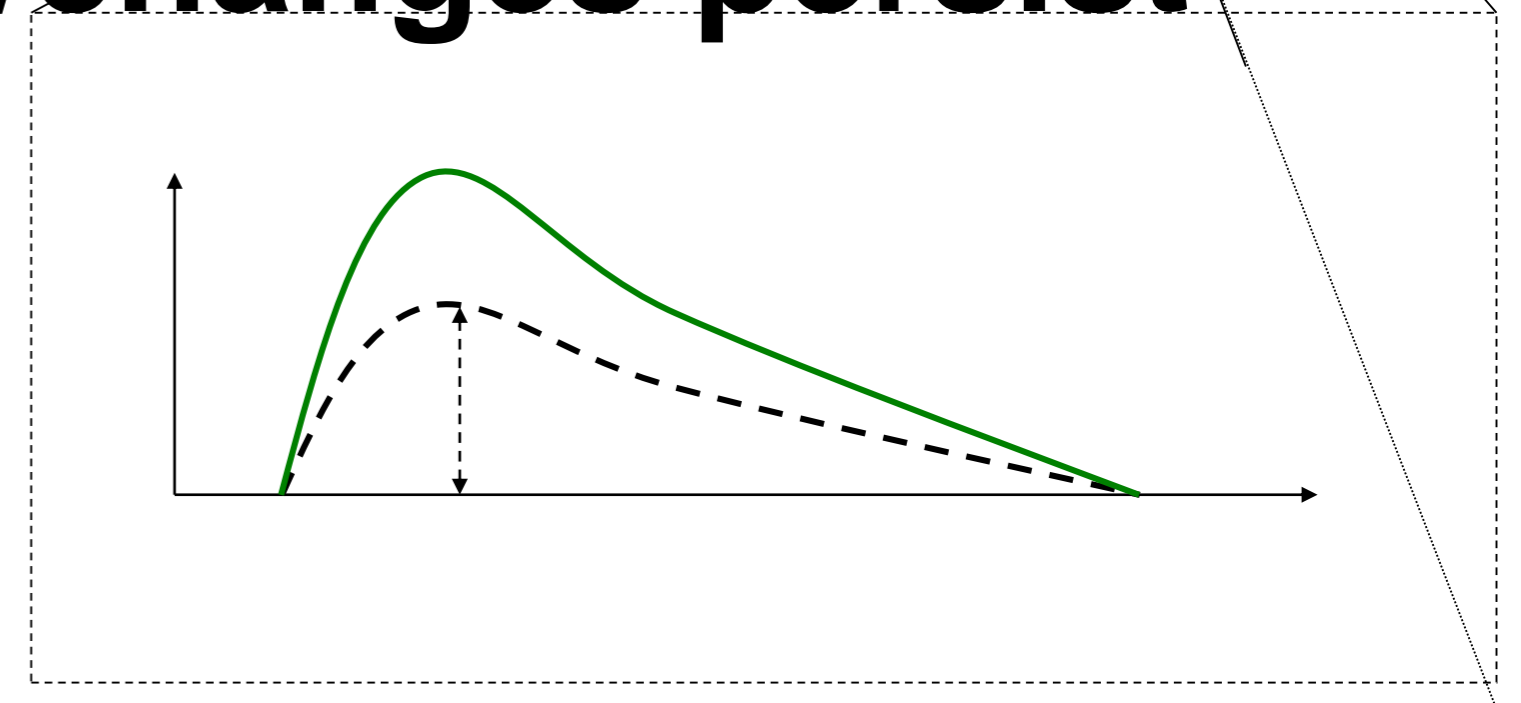

Previous slide.

Experimentalists talk about Long-Term Potentiation (LTP), because once the change is induced it persists for a long time. Interestingly, it is sufficient to make the two neurons fire together for just a few seconds.

Thus induction of plasticity is rapid, but the changes persist for an hour or more.

2. Classical paradigm of LTP induction – pairing

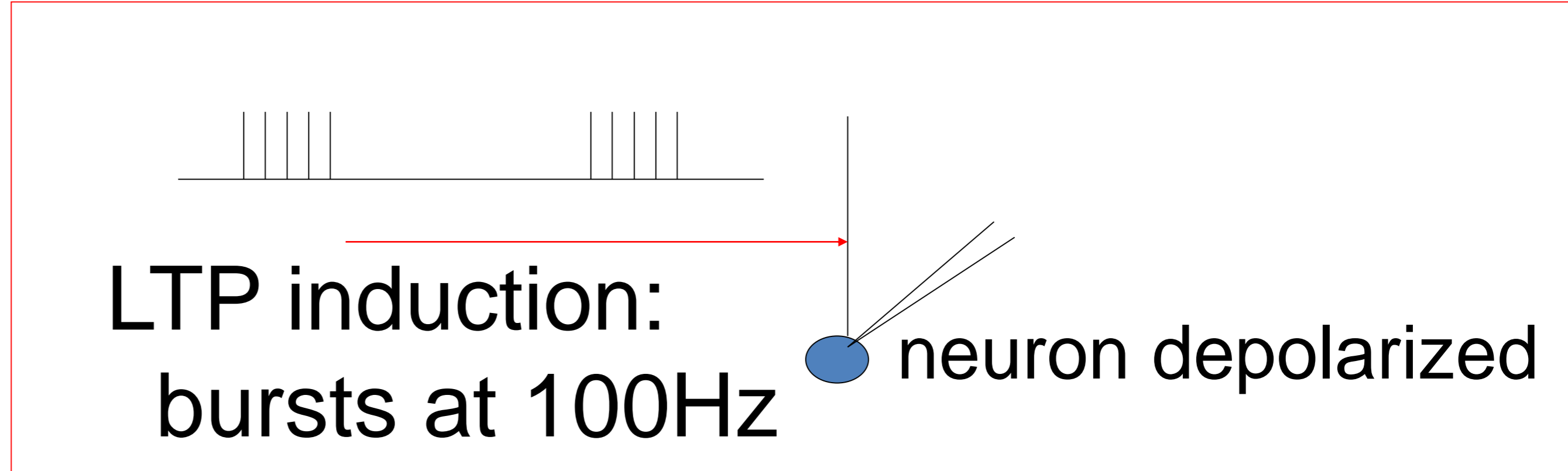
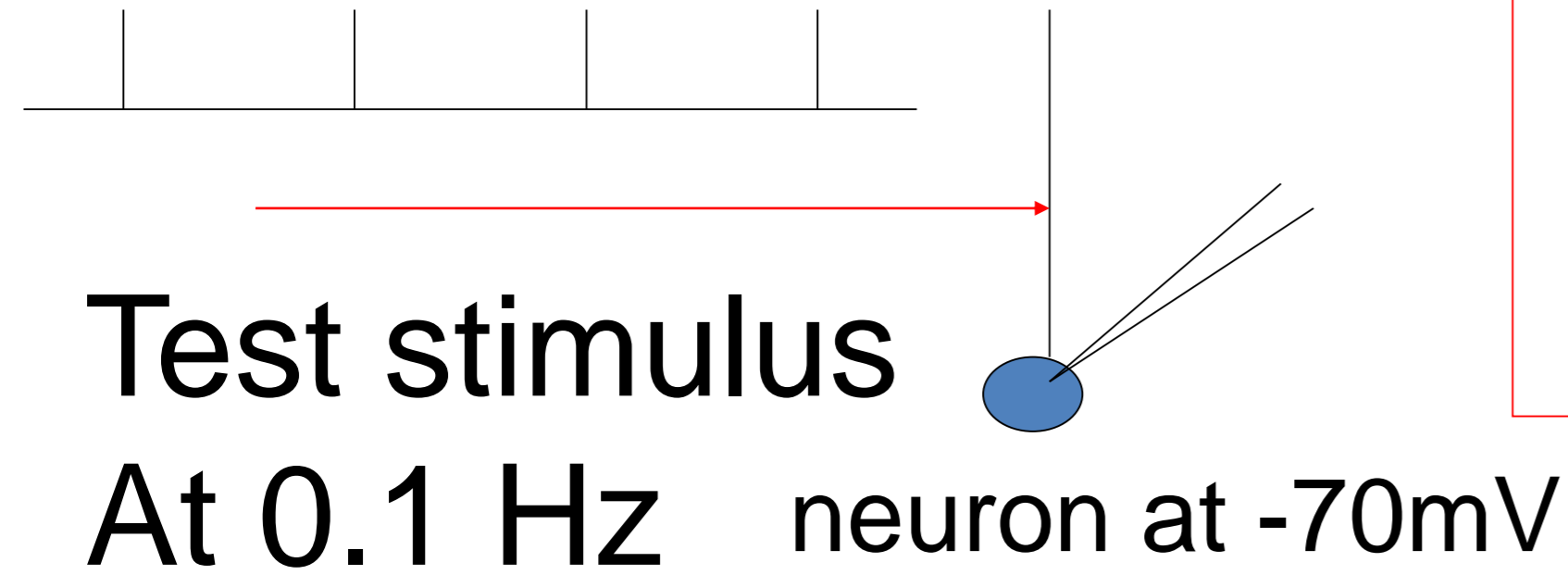

Standard LTP
PAIRING experiment

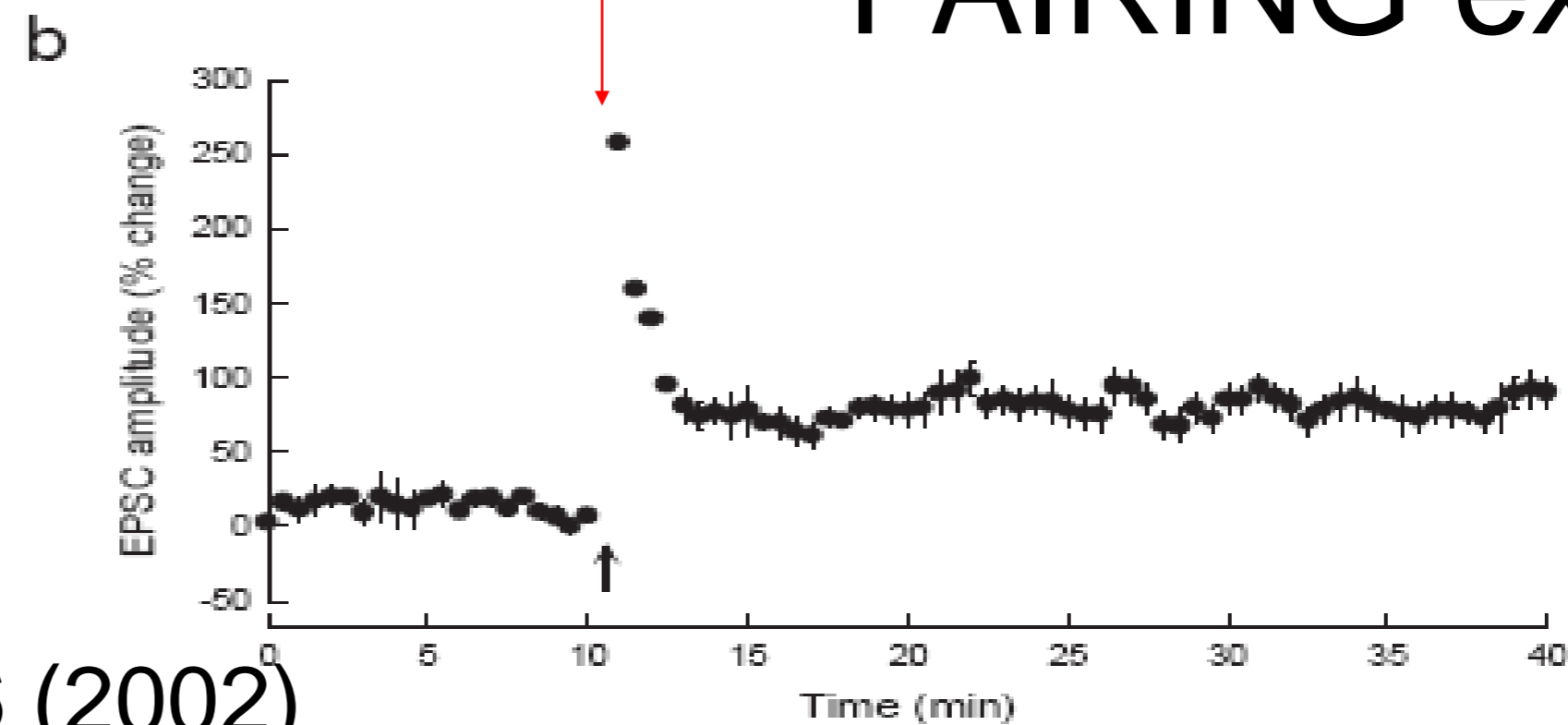
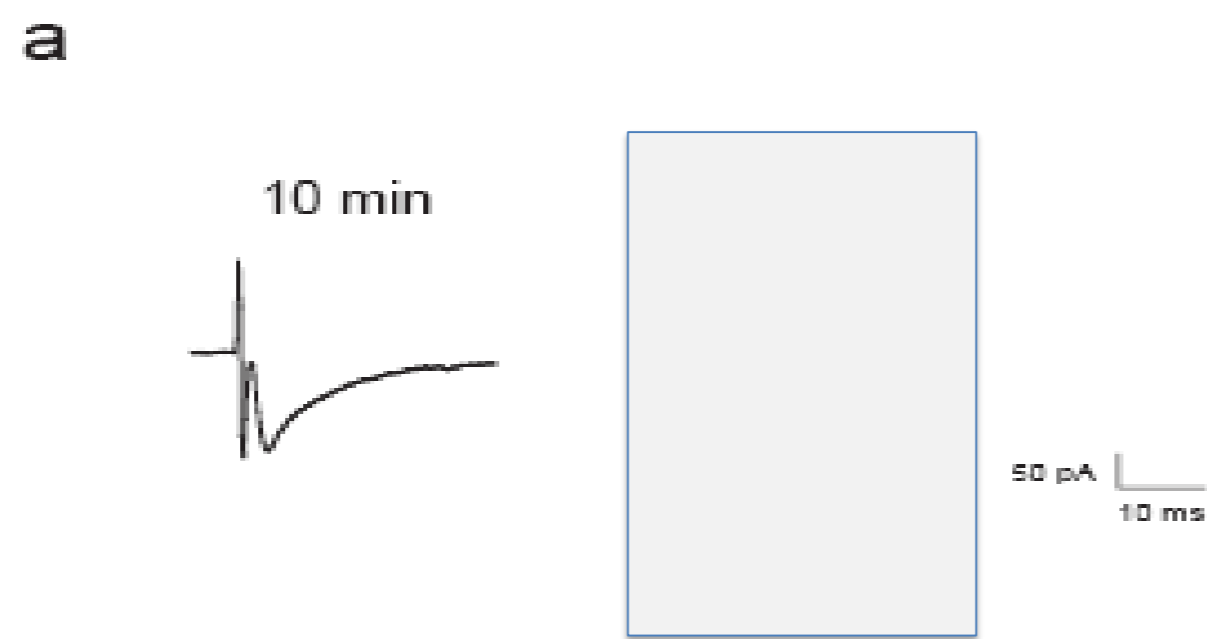

Fig. from Nature Neuroscience **5**, 295 - 296 (2002)

D. S.F. Ling, ... & Todd C. Sacktor

See also: Bliss and Lomo (1973), Artola, Brocher, Singer (1990), Bliss and Collingridge (1993)

Previous slide. Not shown in class.

In one classic paradigm of LTP induction, the presynaptic fibers are strongly stimulated (with bursts of 100 pulses per second, repeated several times) while the postsynaptic neuron is stimulated with an electrode to put above its normal 'resting potential'.

The size of the synapses is measured by the excitatory postsynaptic current (EPSC) which is itself proportional to the EPSP. After the stimulation (which lasts less than a minute) the synapse remains strong for a long time.

The initial transient is of no importance for our discussion.

2. Spike-timing dependent plasticity (STDP)

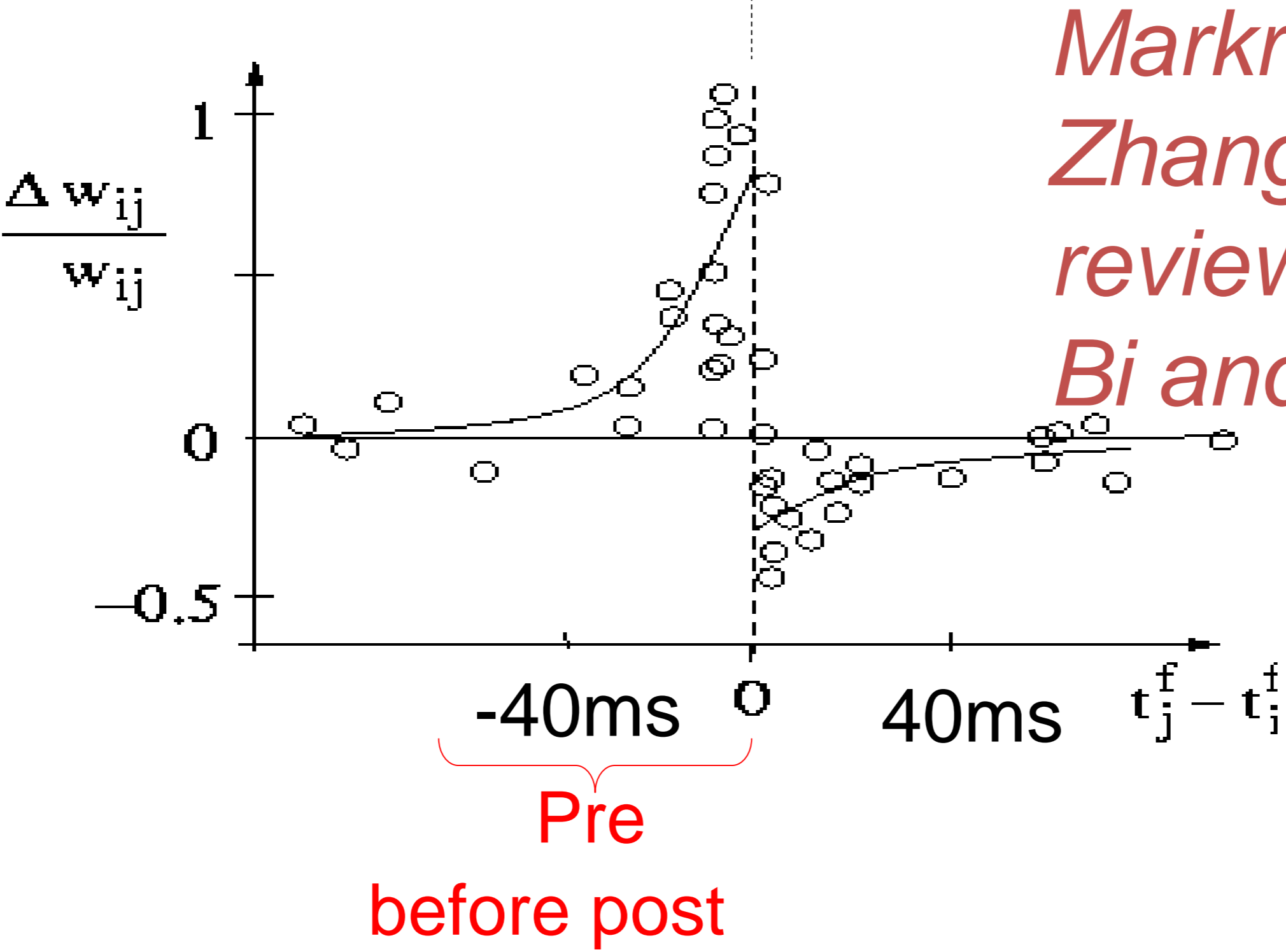
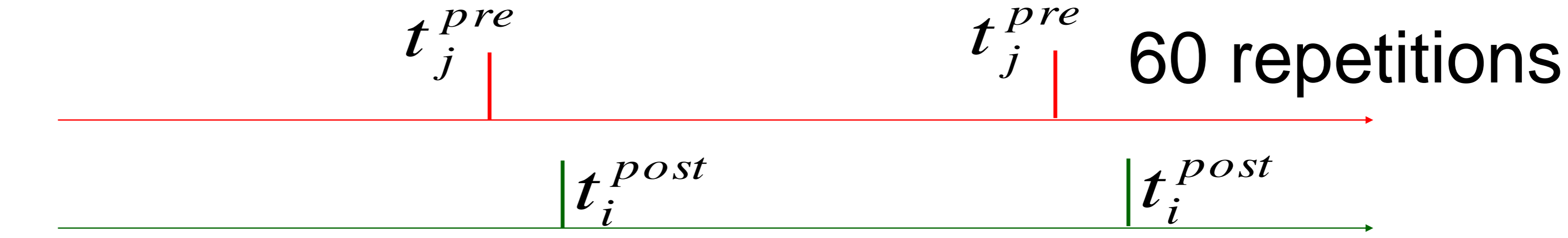
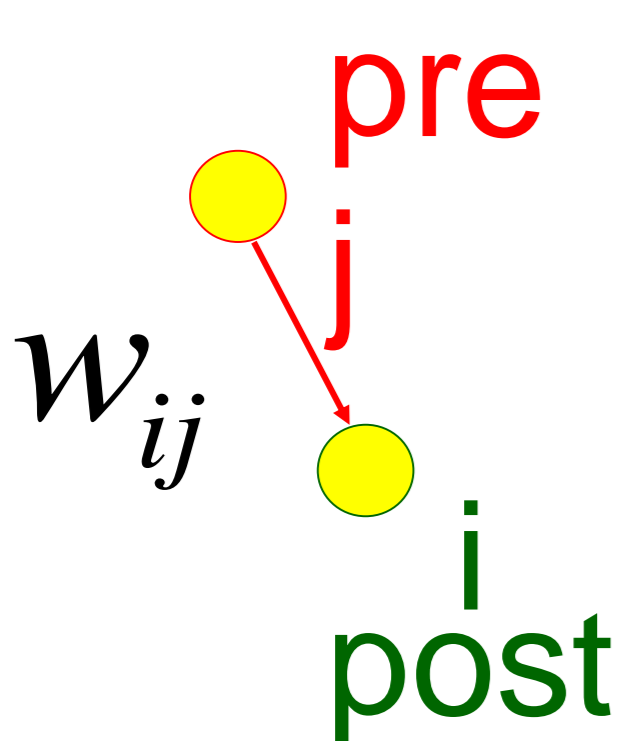

Markram et al, 1995, 1997
Zhang et al, 1998
review:
Bi and Poo, 2001

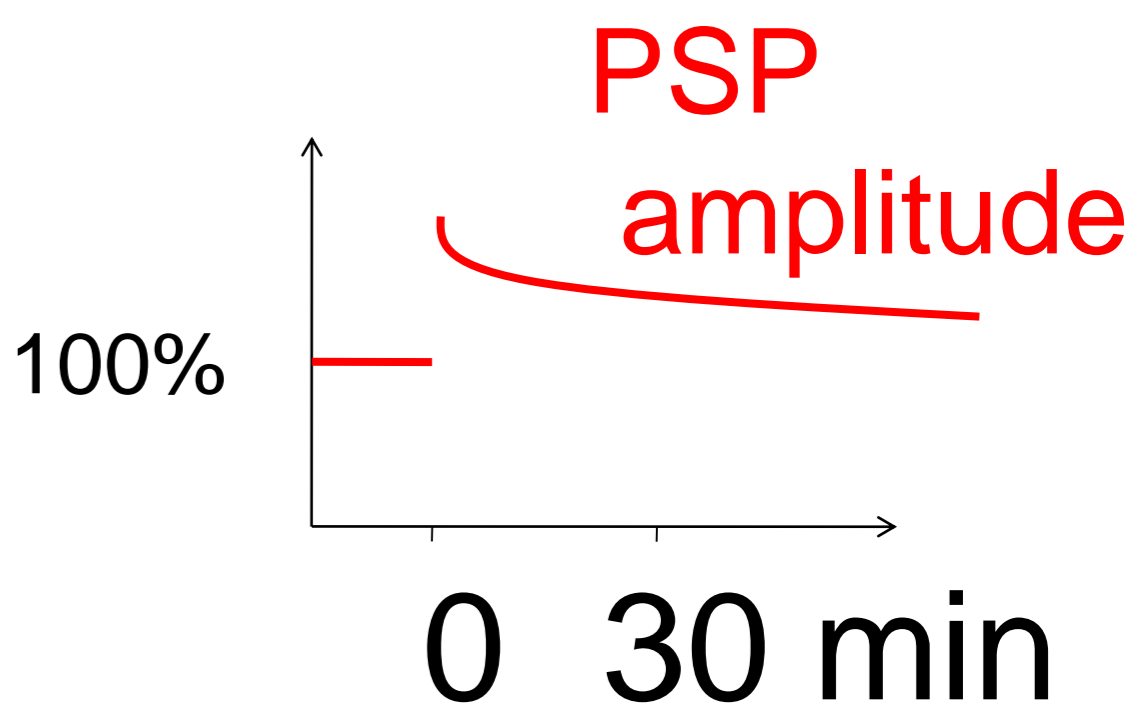

Previous slide.

In the STDP paradigm of LTP induction, the presynaptic neuron is stimulated so that it emits a single spike, and the postsynaptic neuron is also stimulated so that it emits a single spike – either a few milliseconds before or after the presynaptic spike. This stimulation protocol (for example pre-before-post) is then repeated several times.

The increase of the synaptic weight (induced by repeated pre-before-post) persists for a long time.

How much it increases (or decreases) depends on the exact timing of coincidences of pre- and post-spikes on the time scale of 10ms

Since the size of the increase depends on the relative timing of the two spikes, this induction protocol is called Spike-Timing-Dependent Plasticity (STDP).

2. Summary: Synaptic plasticity

Synaptic plasticity

- makes connections stronger or weaker
- can be experimentally induced
- needs 'joint activation' of the two connected neurons
- is **induced rapidly**, but can **last for a long time**
- Spike-timing dependent plasticity is one of many protocols

Hebb rule:

- 'neurons that fire together, wire together'

S. Loewl and W. Singer, Science 1992

'Local rule':

- only the activity of sending and receiving neurons matters

Previous slide.

There are several experimental paradigms to induce synaptic changes.

Most of these paradigms are consistent with the Hebb rule:

Neurons that fire together, wire together, a slogan that was introduced by Loewi and Singer in 1992.

However, in all these Hebbian learning rules and their corresponding experimental paradigms, the role of reward is unclear and not considered.

Hebbian rules are examples of 'LOCAL' learning rules.

- For the change of a connection from neuron j to neuron i , only the activity of these two neurons i and j matters, but not the activity of some other neuron k further away.
- Local means that only information that is locally available at the site of the synapse can be used to drive a weight change. What is available is the value of the weight itself, as well as the state of the postsynaptic neuron and the incoming spikes sent by the presynaptic neuron.

2. Hebbian Learning depends on two factors

1. 'local' learning rule: only local information is used
2. Changes depend on two factors:
 - pre (spike arrival from neuron j)
→ variable x_j
 - post (activation or output spike of postsynaptic neuron i)
→ variable φ_i
3. Sensitive to coincidences
'pre' and 'post'

$$\Delta w_{ij} = F(\text{pre}, \text{post}, w_{ij})$$

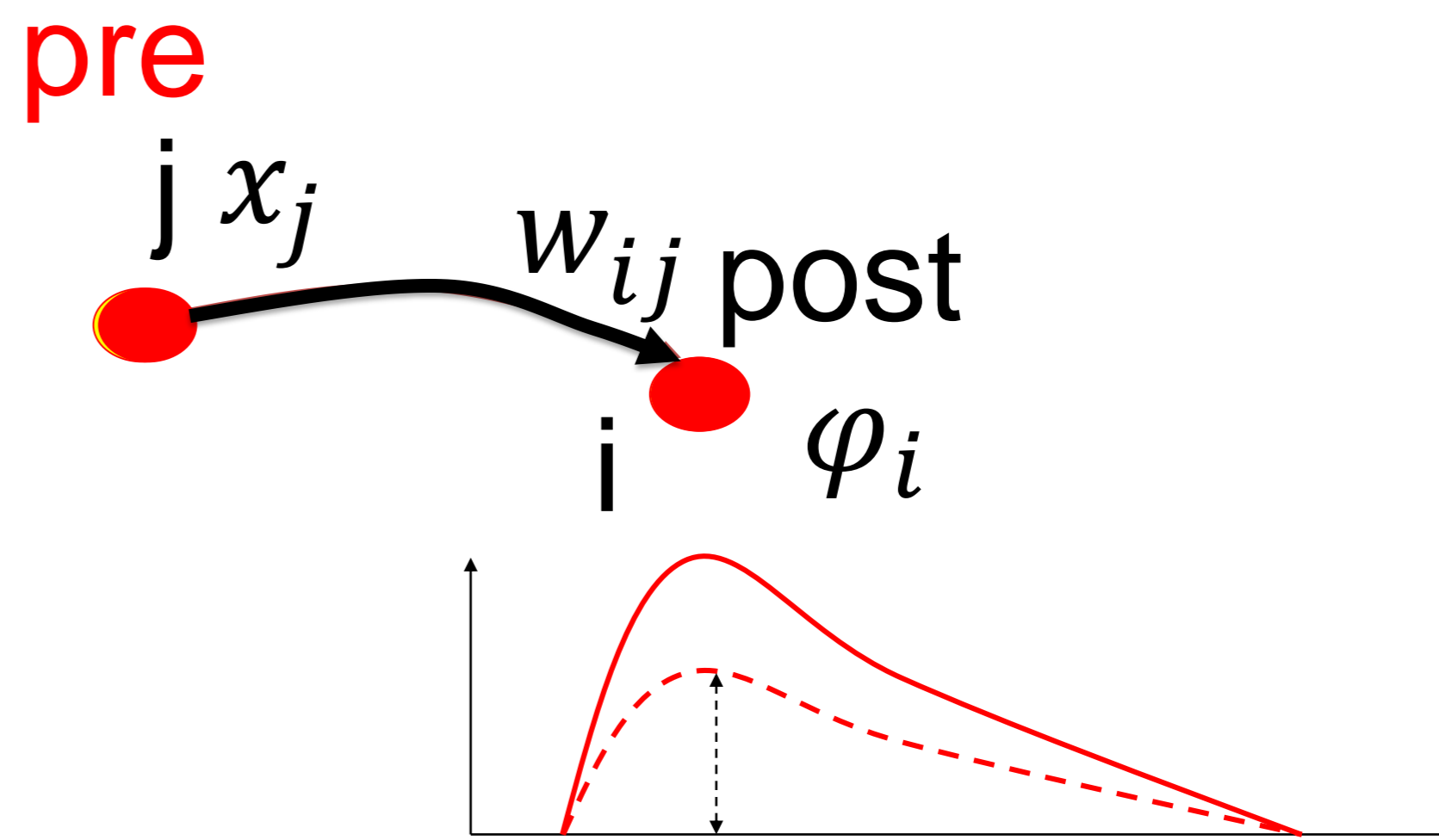

$$\Delta w_{ij} = F(x_j, \varphi_i, w_{ij})$$

$$\Delta w_{ij} = c x_j [\varphi_i - b]$$

Previous slide.

In standard Hebbian learning, the change of the synaptic weight depends on presynaptic activity x_j (the presynaptic factor, pre) and the state of the postsynaptic neuron (a specific example of a postsynaptic factor is $\varphi_i - b$, where b is an arbitrary constant).

1. The rule is local: it depends only on information that is available at the synapse.
2. It is built from two factors: the multiplication of a presynaptic and a postsynaptic factor.
3. Note that it does not contain the notion of reward or success.

Now we want to see whether such rules can be mapped to the math we did in this class!

Quiz. Synaptic Plasticity and Learning Rules

Standard Long-term potentiation

- has an acronym LTP
- takes more than 10 minutes to induce
- lasts more than 30 minutes
- depends on presynaptic activity
AND on state of postsynaptic neuron

Hebbian Learning and STDP:

- Hebbian learning depends on presynaptic activity (presynaptic factor)
AND on state of postsynaptic neuron (postsynaptic factor)
- STDP is a special case of Hebbian learning:
if presynaptic spikes precede postsynaptic spikes
repeatedly by 10ms, LTP is induced

Feedback on Brain Anatomy and Hebbian Learning rules

[] Up to here at least 60 percent of the material was new to me

For 80 percent of the material that we have seen so far

[] I understood the concepts and got a rough or reasonably precise idea of the biological phenomena

Reinforcement Learning and the Brain:

Three-factor learning rules and 'brain-style' computing

1. Coarse Brain Anatomy
2. Synaptic Plasticity
 - basis of 'learning rules' in the brain
 - Hebbian Learning and Long-Term Potentiation (LTP)
- 3. What 'Learning rules' to expect for RL?**
 - Can the brain implement Policy Gradient?

Previous slide.

After this introduction into the learning rules of the brain, let us now ask the following question:

Is the learning rule of policy gradient with softmax output consistent with what we know about learning rules in the brain?

Learning Rules

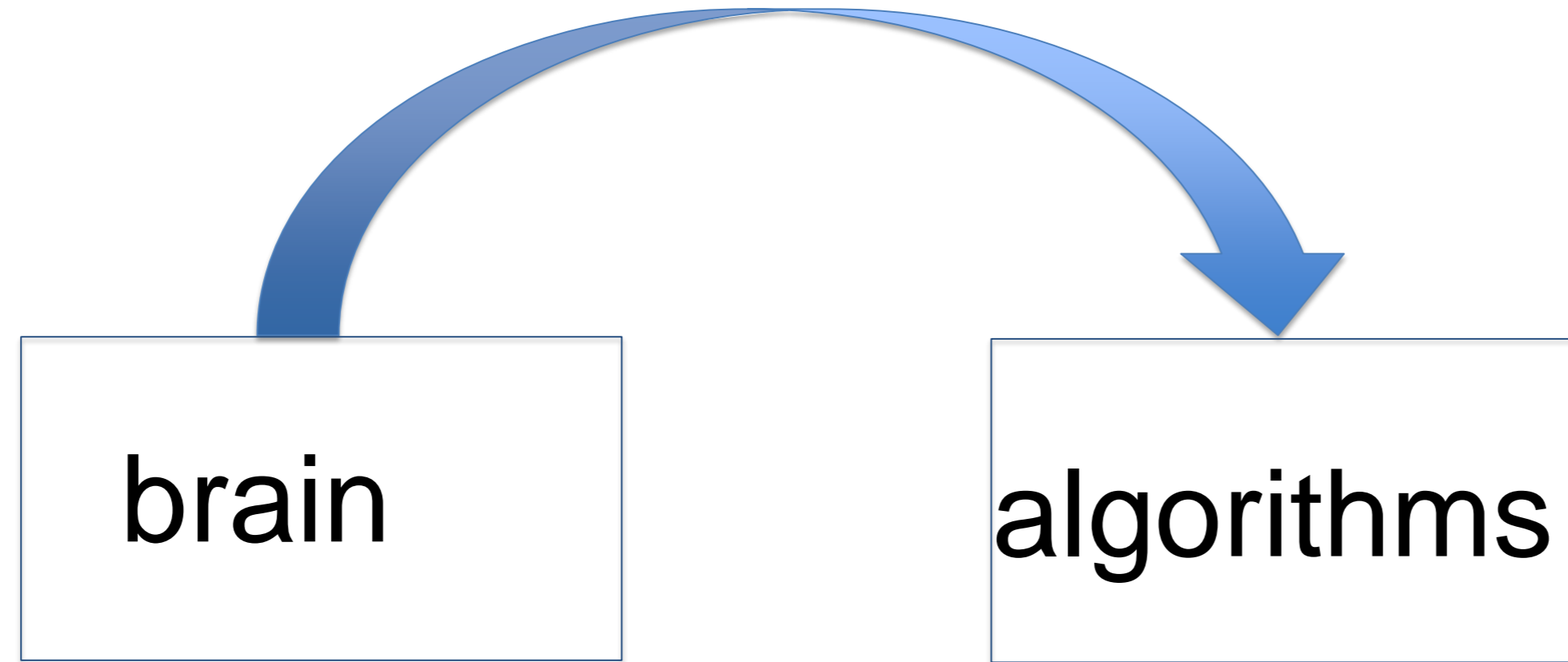

“Can the brain implement policy gradient?”

“Does policy gradient yield a learning rule with
‘presynaptic factor’ and **‘postsynaptic factor’**?”

Previous slide.

The more precise question is:

Does policy gradient yield a learning rule with '**presynaptic factor**' and '**postsynaptic factor**'

Policy gradient rule – can we interpret this as local rule?

North: $a_1=1; a_2=a_3=a_4=0$

East: $a_1=a_2=a_3=0; a_4=1$

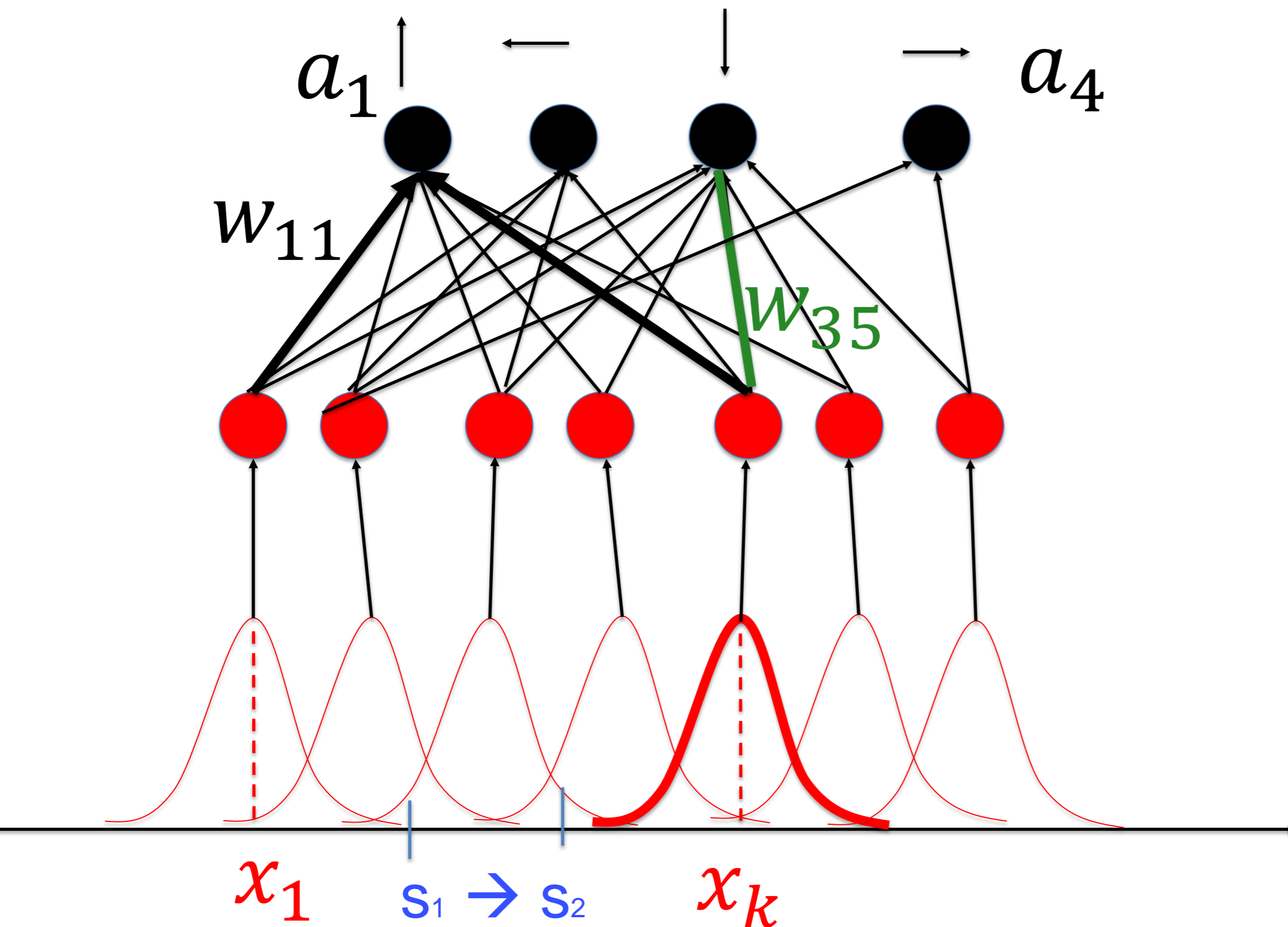

Discrete actions with
1 hot coding

If at time t , the action
 $a_i^t = 1$ is chosen then
 $a_j^t = 0$ for all other
output neurons $j \neq i$

Action choice:
Softmax

(previous slide)

1. The policy is softmax:

this implies that output neurons interact interact such that the policy $\pi(a_i^t = 1|\vec{x})$ is normalized to

$$\sum_i \pi(a_i^t = 1|\vec{x}) = 1$$

2. The coding is 1-hot:

This implies that if at time t , the action $a_i^t = 1$ is chosen then neuron i sends immediately an output signal to all other neurons to inhibit their activity so that

$a_j^t = 0$ for all other output neurons $j \neq i$.

Exercise: Continuous input representation

Ex 1 NOW!

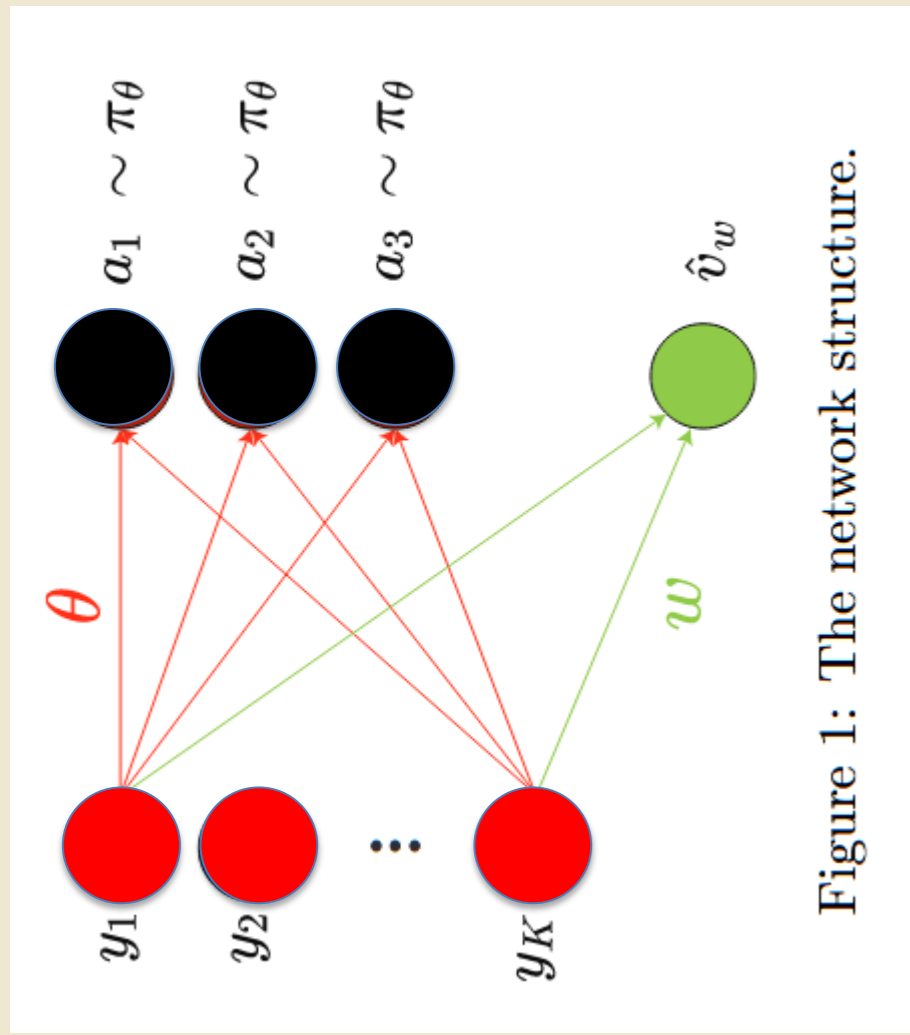

Figure 1: The network structure.

In this exercise you will show how applying Advantage Actor-Critic with eligibility traces to a softmax policy in combination with a linear read-out function leads to a biologically plausible learning rule.

Consider a policy and a value network as in Figure 1 with K input neurons $\{y_k = f(x - x_k)\}_{k=1}^K$. The policy network is parameterized by θ and has three output neurons corresponding to actions a_1, a_2 and a_3 with 1-hot coding. If $a_k = 1$, action a_k is taken. The output neurons are sampled from a softmax policy: The probability of taking action a_i is given by

$$\pi_\theta(a_i = 1|x) = \frac{\exp[\sum_k \theta_{ik} y_k]}{\sum_j \exp[\sum_k \theta_{jk} y_k]} \quad (1)$$

In addition, consider the exponential value network $\hat{v}_w(x) = \exp[\sum_k w_k y_k]$.

Assume the transition to state x^{t+1} with a reward of r^{t+1} after taking action a^t at state x^t . The learning rule for the Advantage Actor-Critic with Eligibility traces is

$$\begin{aligned} \delta &\leftarrow r^{t+1} + \gamma \hat{v}_w(x^{t+1}) - \hat{v}_w(x^t) \\ z^w &\leftarrow \lambda^w z^w + \nabla_w \hat{v}_w(x^t) \\ z^\theta &\leftarrow \lambda^\theta z^\theta + \nabla \log \pi \\ w &\leftarrow w + \alpha^w z^w \delta \\ \theta &\leftarrow \theta + \alpha^\theta z^\theta \delta \end{aligned}$$

Your goal is to show that this learning rule applied to the network of Figure 1 has a biological interpretation.

a. Show that

$$\frac{d}{dw_5} \hat{v}_w(x^t) = y_5^t \hat{v}_w(x^t). \quad (2)$$

b. Interpret the update of the eligibility trace z_5^w in terms of a ‘presynaptic factor’ and a ‘postsynaptic factor’. Can the rule be implemented in biology?

c. Show that

$$\frac{d}{d\theta_{35}} \ln[\pi_\theta(a_i^t = 1|x^t)] = [a_3^t - \pi_\theta(a_3 = 1|x^t)] y_5^t. \quad (3)$$

Hint: simply insert the softmax and then take the derivative and exploit 1-hot coding of actions.

d. Interpret the update of the eligibility trace z_{35}^θ in terms of a ‘presynaptic factor’ and a ‘postsynaptic factor’. Can the rule be implemented in biology?

actor-critic update rule

$$\begin{aligned} \delta &\leftarrow r^{t+1} + \gamma \hat{v}_w(x^{t+1}) - \hat{v}_w(x^t) \\ z^w &\leftarrow \lambda^w z^w + \nabla_w \hat{v}_w(x^t) \\ z^\theta &\leftarrow \lambda^\theta z^\theta + \nabla_\theta \pi_\theta(a^t|x^t) \\ w &\leftarrow w + \alpha^w z^w \delta \\ \theta &\leftarrow \theta + \alpha^\theta z^\theta \delta \end{aligned}$$

I need the result for lecture.

Lecture continues at 14h15

(previous slide)

Your notes.

Discussion of Exercise: Comparison with Biology

parameter = weight w_{ij}

Stimulus

success

pre

j

i

post

Change depends on pre and post

Three factors: success

post

pre

$$\Delta w_{ij} = \eta \quad S(a_i^t, \vec{x}) \left[a_i^t - \langle a_i(\vec{x}) \rangle \right] x_j$$

postsynaptic factor is

'activity – expected activity'

Previous slide.

Reinforcement Learning includes a set of very powerful algorithm – as we have seen in previous lectures. Here S denotes the success, which is reward (in REINFORCE) or reward minus baseline (in REINFORCE with baseline), or TD error (in the advantage actor-critic)

For today the big question is:

Is the structure of the brain suited to implement reinforcement learning algorithms?

If so which one? Q-learning or SARSA? How about Policy gradient?

Is the brain architecture compatible with an actor-critic structure?

These are the questions we will address in the following sections.

A key element is the algorithmic structure of a ‘Three-factor Rule’.

The specific rule here is instantaneous (no eligibility trace).

The exercise discusses a version with eligibility trace. If you have calculated the solution with eligibility trace, you can set $\lambda=0$ to remove the eligibility trace.

Three-factor rule

Change depends

- Local factor **pre**
- Local factor **post**
- Global broadcast factor **success**
- **Success** could be **reward** or **TD error**

Stimulus

success

pre



j



i post

Three factors: **success** **post** **pre**

$$\Delta w_{ij} = \eta \quad S(a_i^t, \vec{x}) \left[\overbrace{a_i^t - \langle a_i(\vec{x}) \rangle}^{\text{post}} \right] x_j$$

postsynaptic factor is

'activity – expected activity'

Previous slide.

The result of Reinforcement Learning with an actor-critic leads to a three-factor rule:

- A presynaptic factor, activity of the sending neuron, such as spike arrival at the synapse.
- A postsynaptic factor: its activity (output spikes, $a=1$ or inactive $a=0$) minus the 'mean drive' for this state $\langle y_i(\vec{x}) \rangle = \pi(a_i | \vec{x})$
- In addition to the above two local factors (similar to a Hebb rule) there is one global broadcasting factor. The success.
- The success could be the reward itself (REINFORCE algorithm), or the TD signal (advantage actor critic).
- The specific version here is the one without eligibility traces. We will come back to eligibility traces later.

Reinforcement Learning and the Brain:

Three-factor learning rules and 'brain-style' computing

1. Coarse Brain Anatomy
2. Synaptic Plasticity
3. **Three-factor Learning Rules**
 - RL gives rise to three-factor learning rules
 - 3-factor rules vs. 2-factor rules
 - Neuromodulators act as 3rd factor
 - Experiments supporting three-factor learning rules

Previous slide.

Since Hebbian learning rules are limited, we have to extend the framework and include a 'third factor' that could represent reward.

3. Classification of synaptic changes: unsupervised learning

Hebbian Learning = unsupervised learning

no notion of reward
or success.

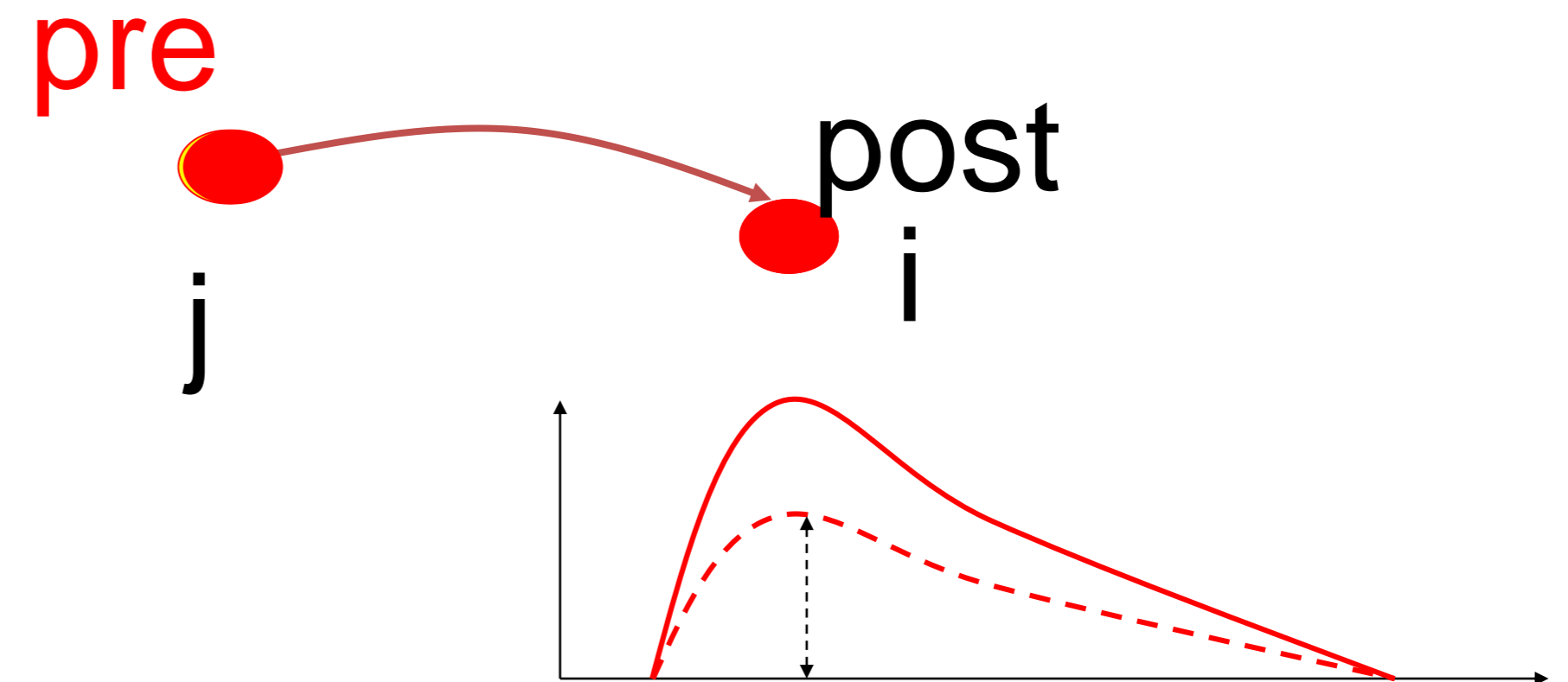

$$\Delta w_{ij} = F(pre, post, w_{ij})$$

Previous slide.

In standard Hebbian learning, the change of the synaptic weight depends only on presynaptic activity (pre) and the state of the postsynaptic neuron (post). The rule is local, and does not contain the notion of reward or success.

The value of the weight w_{ij} is measured by sending a test-pulse across the synapse. The change of the weight is a function of 'pre' and 'post' and the weight itself where 'pre' and 'post' are rather general variables.

Is Hebbian Learning sufficient? No! – We need a third factor!

Image: Fremaux and Gerstner, *Front. Neur. Circ.*, 2015

Eligibility trace:
Synapse keeps memory of pre-post coincidences over a few seconds

Dopamine:
Reward/success

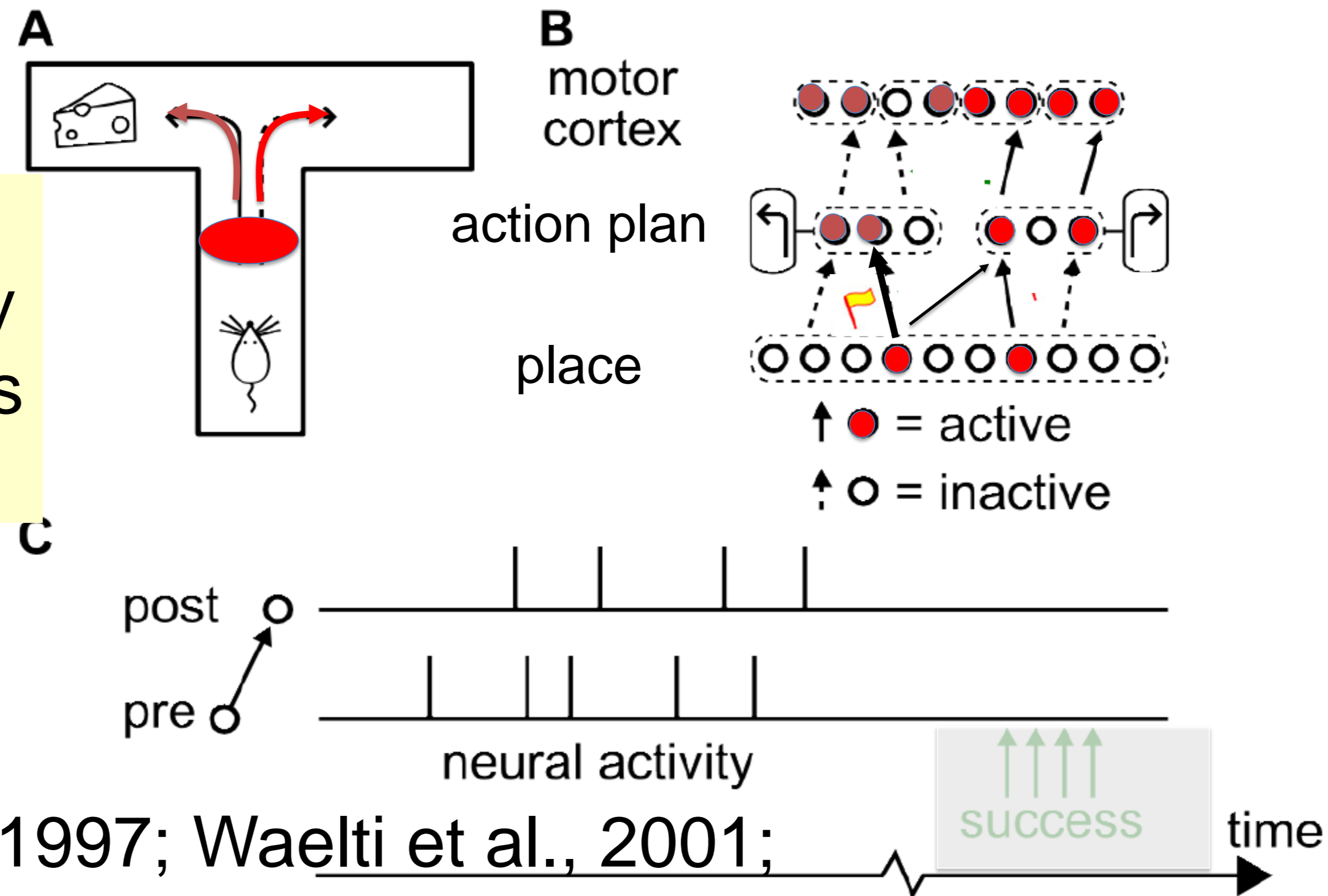

→ **Reinforcement learning: $\text{success} = \text{reward} - (\text{expected reward})$**

TD-learning, SARSA, Policy gradient (book: Sutton and Barto, 2018)

Previous slide.

Hebbian learning as it stands is not sufficient to describe learning in a setting where rewards play a role. If joint activity of pre- and post causes stronger synapses, the rat is likely to repeat the same unrewarded action a second time. A three-factor rule adds the influence of a neuromodulator (e.g., dopamine): reward-modulate plasticity.

Hypothetical functional role of neuromodulated synaptic plasticity.

(A) Schematic reward-based learning experiment. An animal learns to perform a desired sequence of actions (e.g., move straight, then turn left) in a T-maze through trial-and-error with rewards (cheese).

(B) The current position (“place”) of the animal in the environment is represented by an assembly of active cells in the hippocampus. These cells connect to neurons (e.g., in the dorsal striatum) which code for high-level actions at the decision point, e.g., “turn left” or “turn right.” These neurons in turn project to motor cortex neurons, responsible for the detailed implementation of actions. Connections between neurons that are active together are marked (flag/eligibility trace).

(C) Neuromodulator timing. While spikes occur on the time scale of milliseconds, the success signal (green arrows/shaded) may come a few seconds later.

3. Classification of synaptic changes: Reinforcement Learning

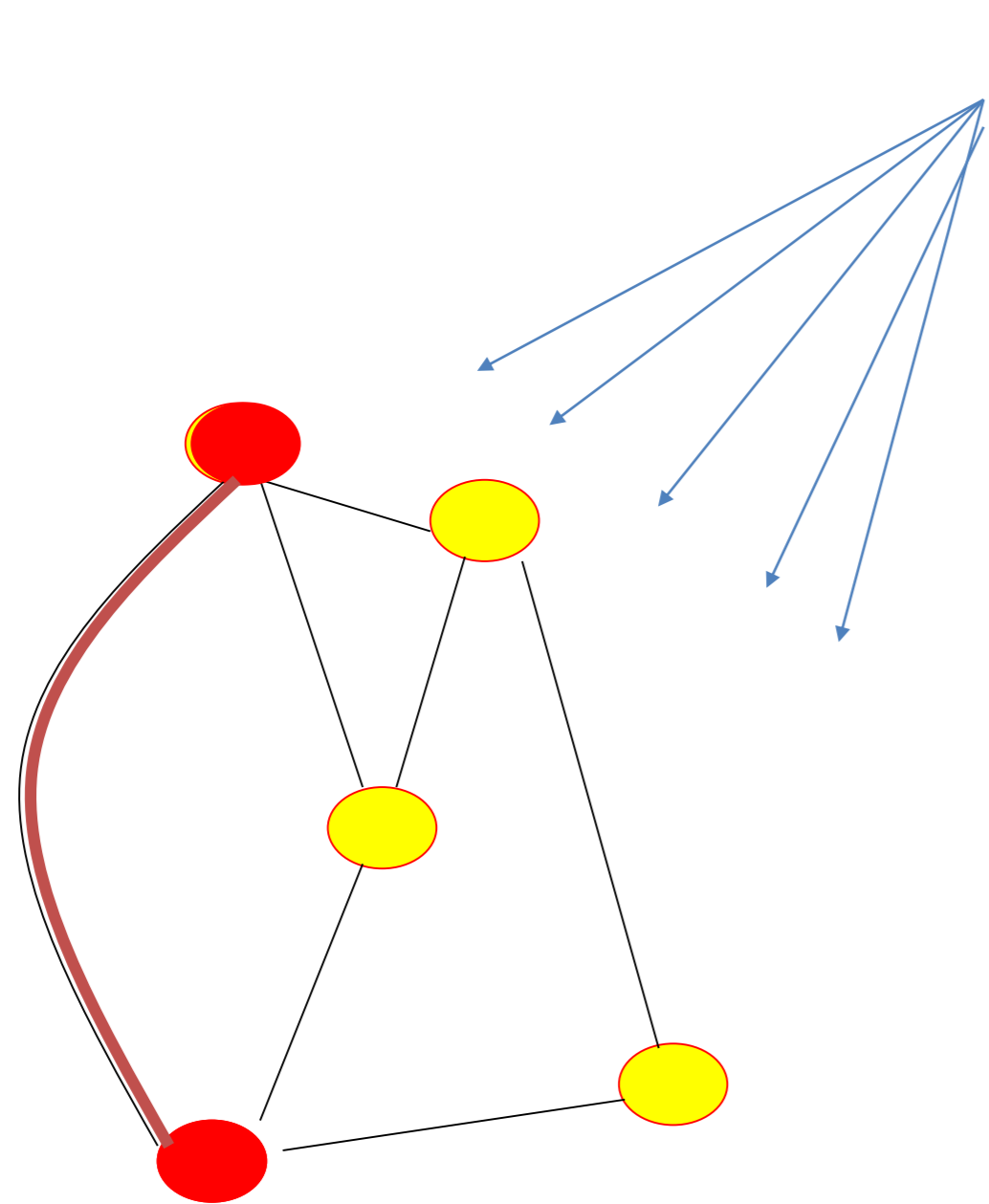

SUCCESS Reinforcement Learning
= reward + Hebb

$$\Delta w_{ij} \propto F(\underset{\substack{\uparrow \\ \text{local}}}{pre}, \underset{\substack{\uparrow \\ \text{local}}}{post}, \underset{\substack{\uparrow \\ \text{global}}}{SUCCESES}, w_{ij})$$

local

global

broadly diffused signal:
neuromodulator

Previous slide.

For the moment we say that reinforcement learning depends on three factors: the Hebbian pre- and postsynaptic factor plus a success signal related to reward. We will get more precise later.

3. Classification of synaptic changes

unsupervised vs reinforcement

LTP/LTD/Hebb

Theoretical concept

- passive changes
- exploit statistical correlations

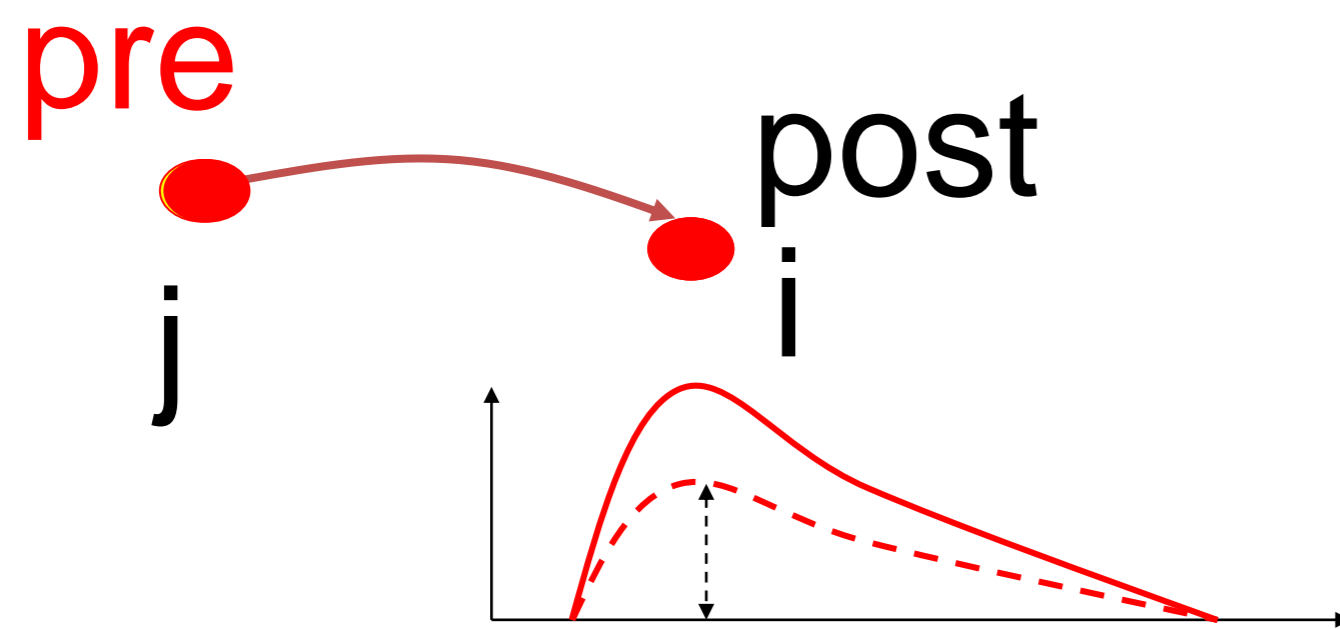

Functionality

- useful for development
(develop good filters)

Reinforcement Learning

Theoretical concept

- conditioned changes
- maximise reward

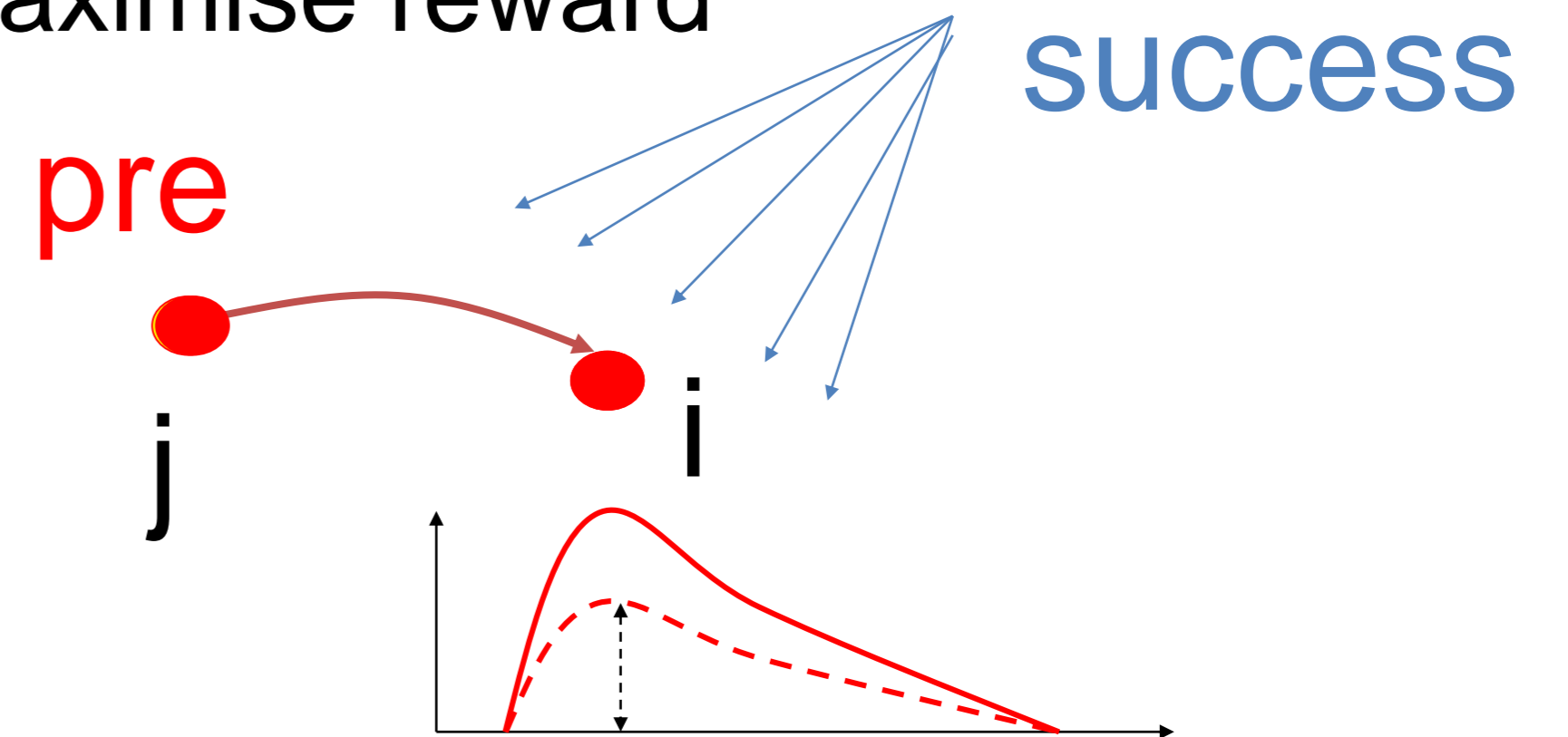

Functionality

- useful for learning
a new behavior

Previous slide.

This does not mean the standard Hebbian learning is wrong: in fact it is very useful for the development of generic synaptic connections, e.g., to make neurons develop good filtering properties that pick up relevant statistical signals in the stream of input. Unsupervised Hebbian learning can for example implement Principal Component Analysis or Independent Component Analysis.

The three-factor rules are relevant for learning novel behaviors via feedback through reward.

3. Three-factor rule: the role of neuromodulators

= Hebb-rule gated by a neuromodulator

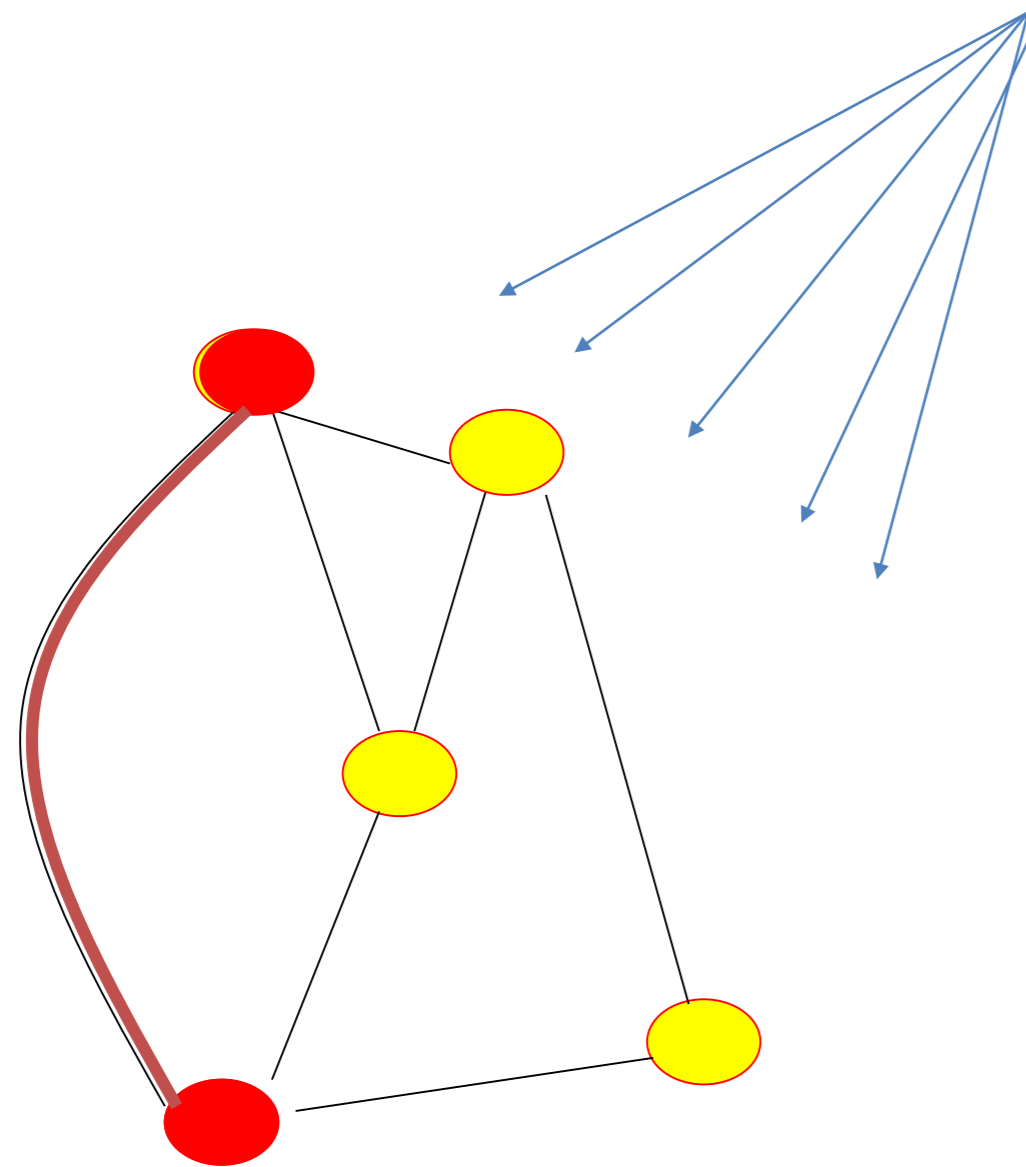

Neuromodulators: Interestingness, surprise;
attention; novelty

$$\Delta w_{ij} \propto F(\underset{\substack{\uparrow \\ \text{local}}}{pre}, \underset{\substack{\uparrow \\ \text{local}}}{post}, \underset{\substack{\uparrow \\ \text{global}}}{MOD})$$

local

global

Previous slide.

To summarized: The three-factor rules have a Hebbian component: pre- and postsynaptic activity together, but in addition the third factor which is related to neuromodulators.

There are several neuromodulators in the brain.

Neuromodulator projections

- 4 or 5 neuromodulators
- near-global action

Dopamine/reward/TD:
Schultz et al., 1997,
Schultz, 2002

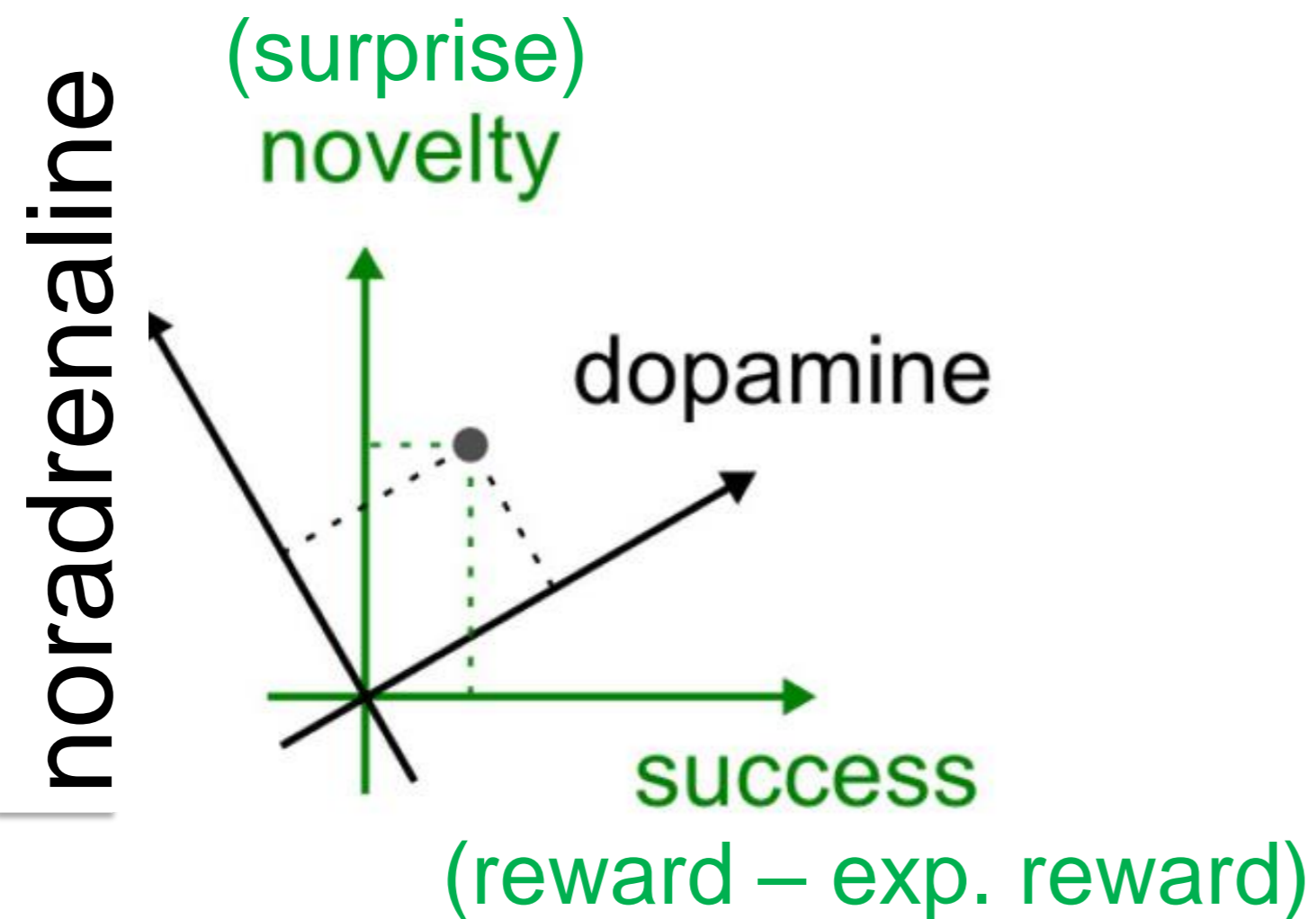
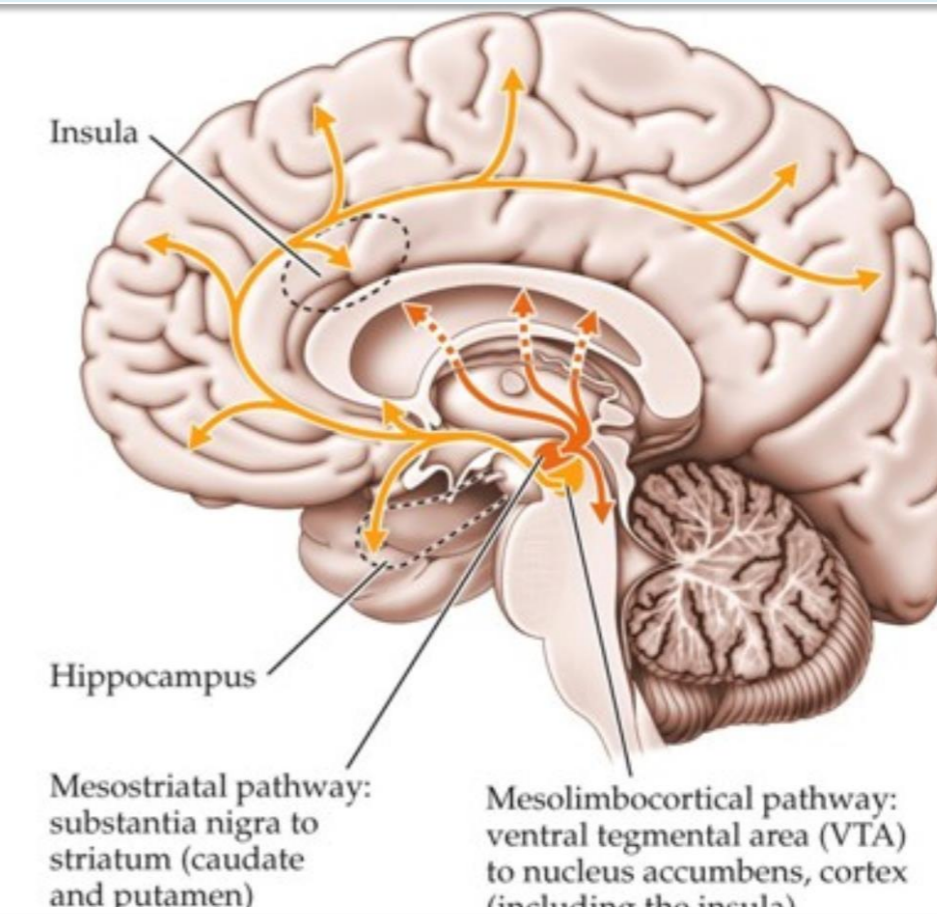

Image:
Fremaux and Gerstner, Frontiers (2016)

Image: *Biological Psychology, Sinauer*

Dopamine (DA)



Noradrenaline (NE)

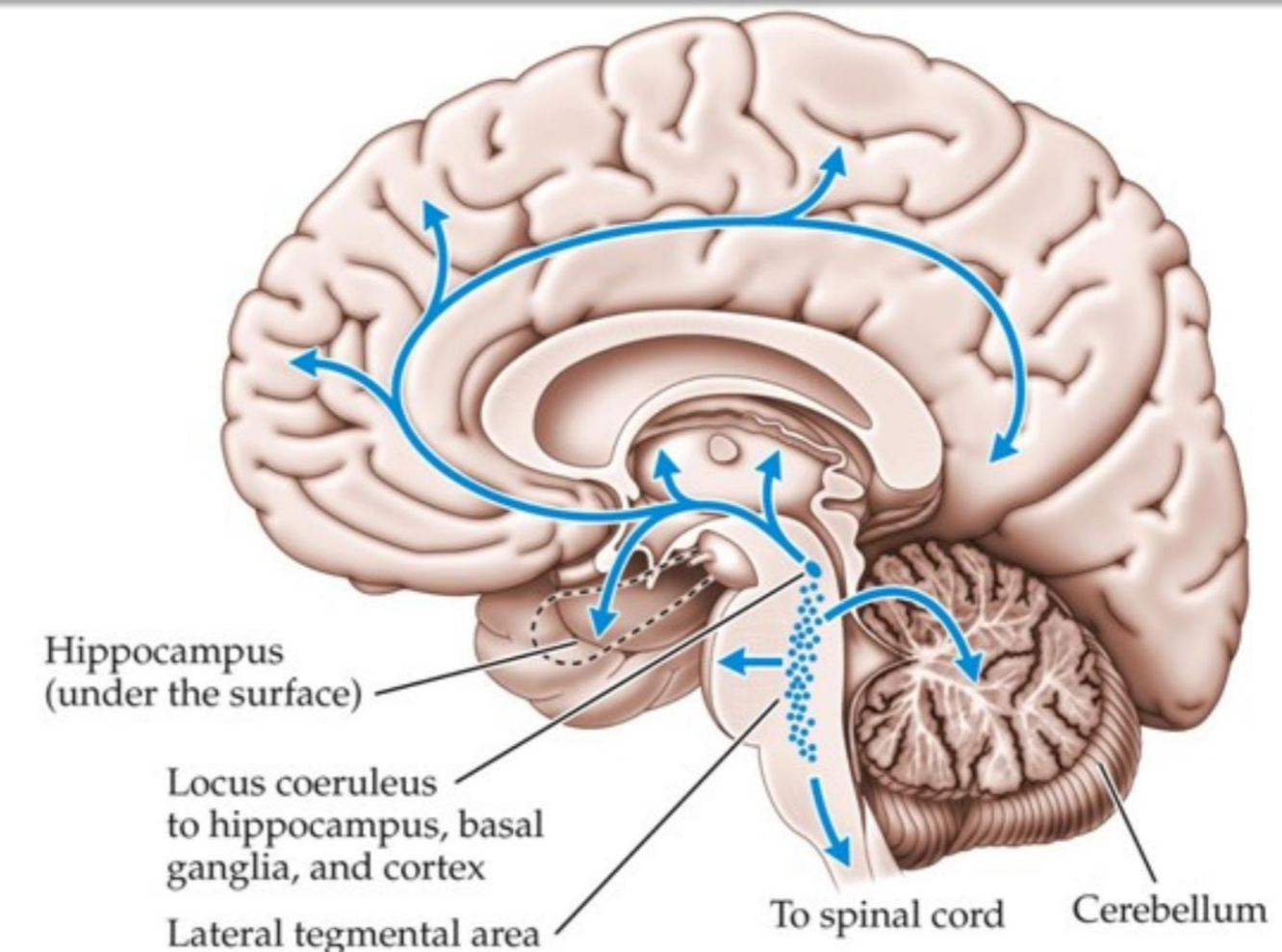

Previous slide.

The most famous neuromodulator is dopamine (DA) which is related to reward, as we will see.

But there are other neuromodulators such as noradrenaline (also called norepinephrine, NE) which is related to surprise.

Left: the mapping between neuromodulators and functions is not one-to-one. Indeed, dopamine also has a 'surprise' component.

Right: most neuromodulators send axons to large areas of the brain, in particular to several cortical areas. The axons branch out in thousands of branches. Thus the information transmitted by a neuromodulator arrives nearly everywhere. In this sense, it is a 'global' signal, available in nearly all brain areas.

3. Formalism of Three-factor rules with eligibility trace

Three-factor rule defines a framework

x_j = activity of presynaptic neuron

φ_i = activity of postsynaptic neuron

Step 1: co-activation sets eligibility trace

$$\Delta z_{ij} = \eta f(\varphi_i) g(x_j)$$

Step 2: eligibility trace decays over time

$$z_{ij} \leftarrow \lambda z_{ij}$$

Step 3: eligibility trace translated into weight change

$$\Delta w_{ij} = \eta M(S(\vec{\varphi}, \vec{x})) z_{ij}$$

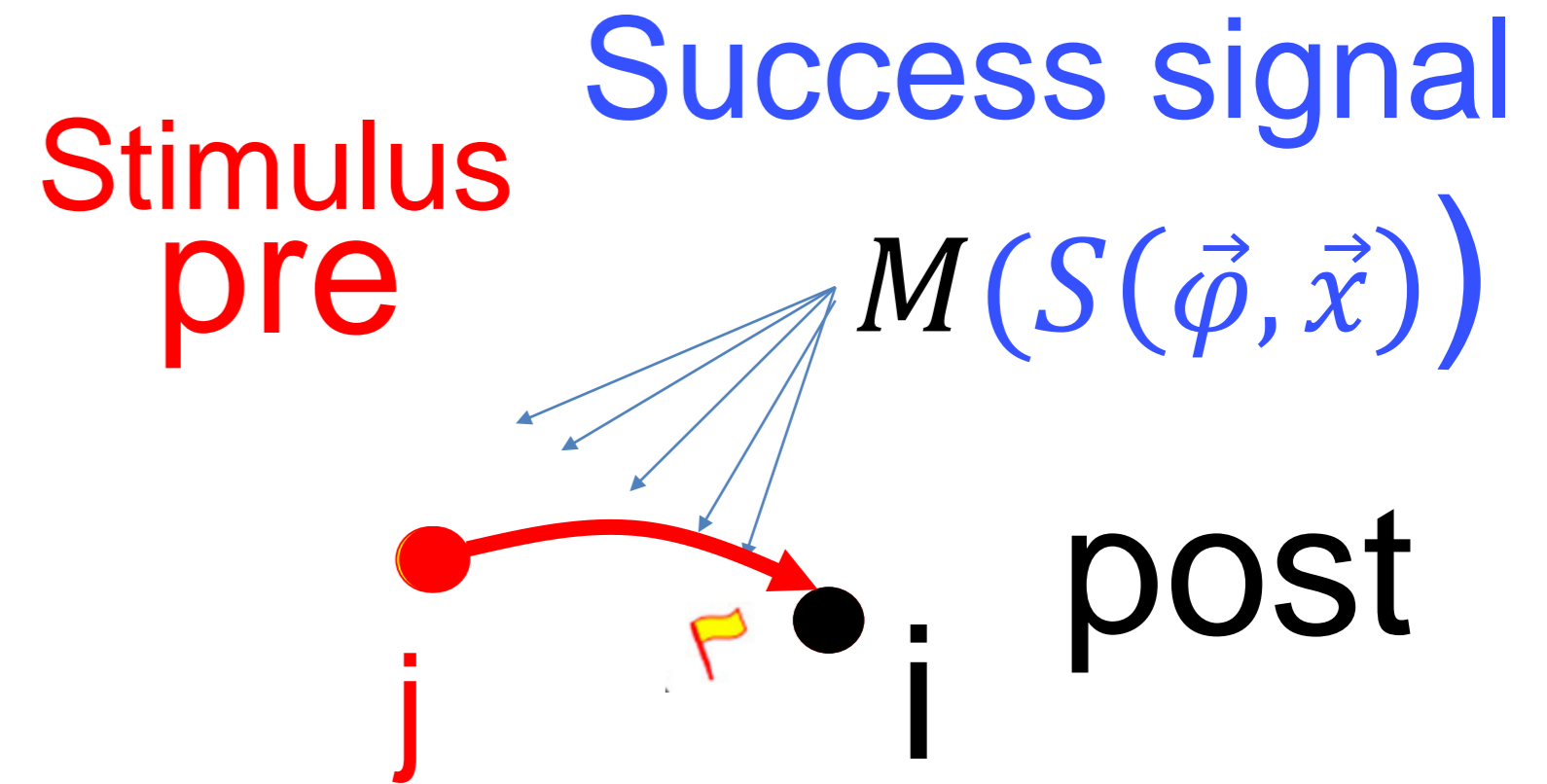

Previous slide.

Three-factor rules are implementable with eligibility traces.

1. The joint activation of pre- and postsynaptic neuron sets a 'flag'. This step is similar to the Hebb-rule, but the change of the synapse is not yet implemented. The exact condition for setting the eligibility trace COULD be the one from the actor-critic/policy gradient framework, but could also be some other combination of pre-and postsynaptic factors.

2. The eligibility trace decays over time

3. However, if a neuromodulatory signal M arrives before the eligibility trace has decayed to zero, an actual change of the weight is implemented.

The change is proportional to

- the momentary value of the eligibility trace
- the value of the success signal

The success signal can be broadcasted by a neuromodulator signaling

- Reward (minus reward-baseline) OR
- TD-error

3. Hebbian LTP versus Three-factor rules

Hebbian coactivation:
pre-post-post-post

Hebbian coactivation:
but no post-spikes

Scenario of three-factor
rule: Hebb+modulator

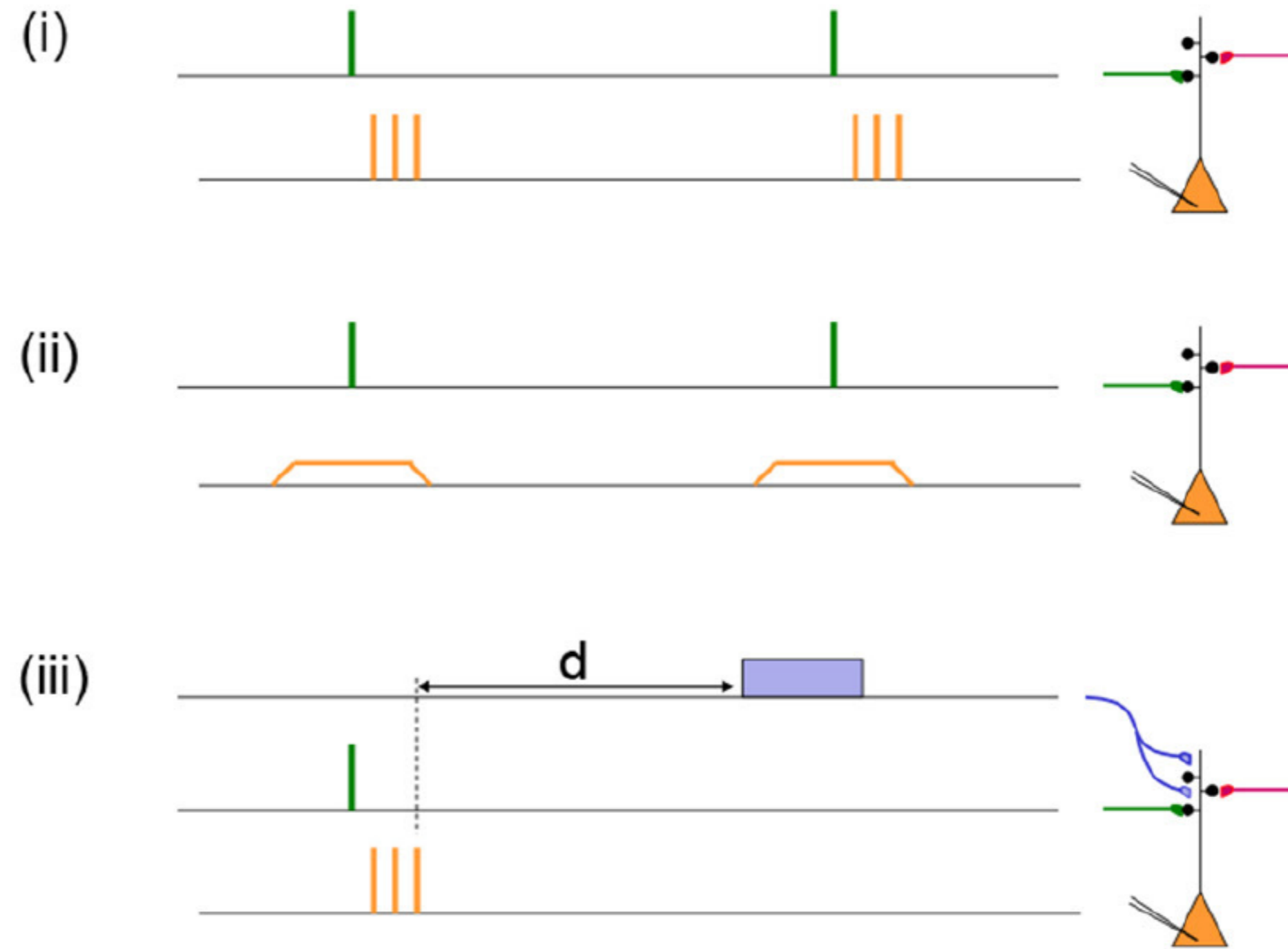

Neuromodulator can come with a delay of 1s

Image: Gerstner et al. (2018, review paper in Frontiers)

Previous slide.

The joint activation of pre- and postsynaptic neuron sets a 'flag'. This step is similar to the Hebb-rule, but the change of the synapse is not yet implemented.

Note that joint activation can imply spikes of pre- (green) and postsynaptic (orange) neuron (top);

Or spikes of a presynaptic neuron combined with a weak voltage increase in the postsynaptic neuron (middle).

Bottom: three-factor rule only if a neuromodulatory signal M arrives before the eligibility trace has decayed to zero, an actual change of the weight is implemented. The neuromodulator arrives through the branches

The ideas of three-factor rules can be traced back over several decades.

Early papers were Crow 1968, Barto, 1983/1985, Schultz 1997,

First experimental papers Schultz 1997

3. Three-factor rules: synaptic flags and delayed reward (mod)

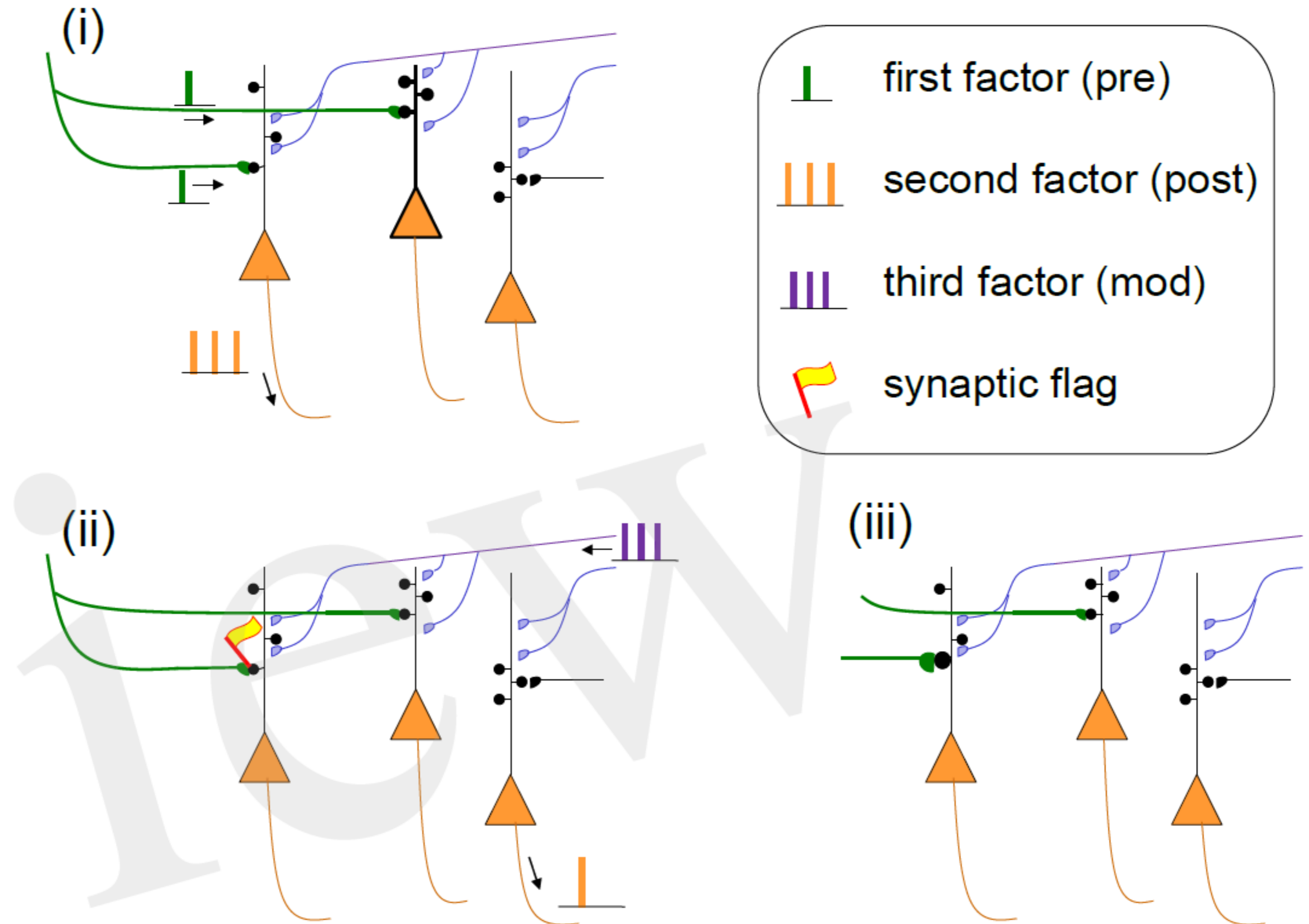

synaptic flag
plays role of
eligibility trace

Fig: Gerstner et al. 2018

Previous slide.

Specificity of three-factor learning rules.

- (i) Presynaptic input spikes (green) arrive at two different neurons, but only one of these also shows postsynaptic activity (orange spikes).
- (ii) A synaptic flag is set only at the synapse with a Hebbian co-activation of pre- and postsynaptic factors; the synapse become then eligible to interact with the third factor (blue). Spontaneous spikes of other neurons do not interfere.
- (iii) The interaction of the synaptic flag (eligibility trace) with the third factor leads to a strengthening of the synapse (green).

3. Recent experiments for Three-factor rules

Neuromodulators for reward, interestingness, surprise;
attention; novelty

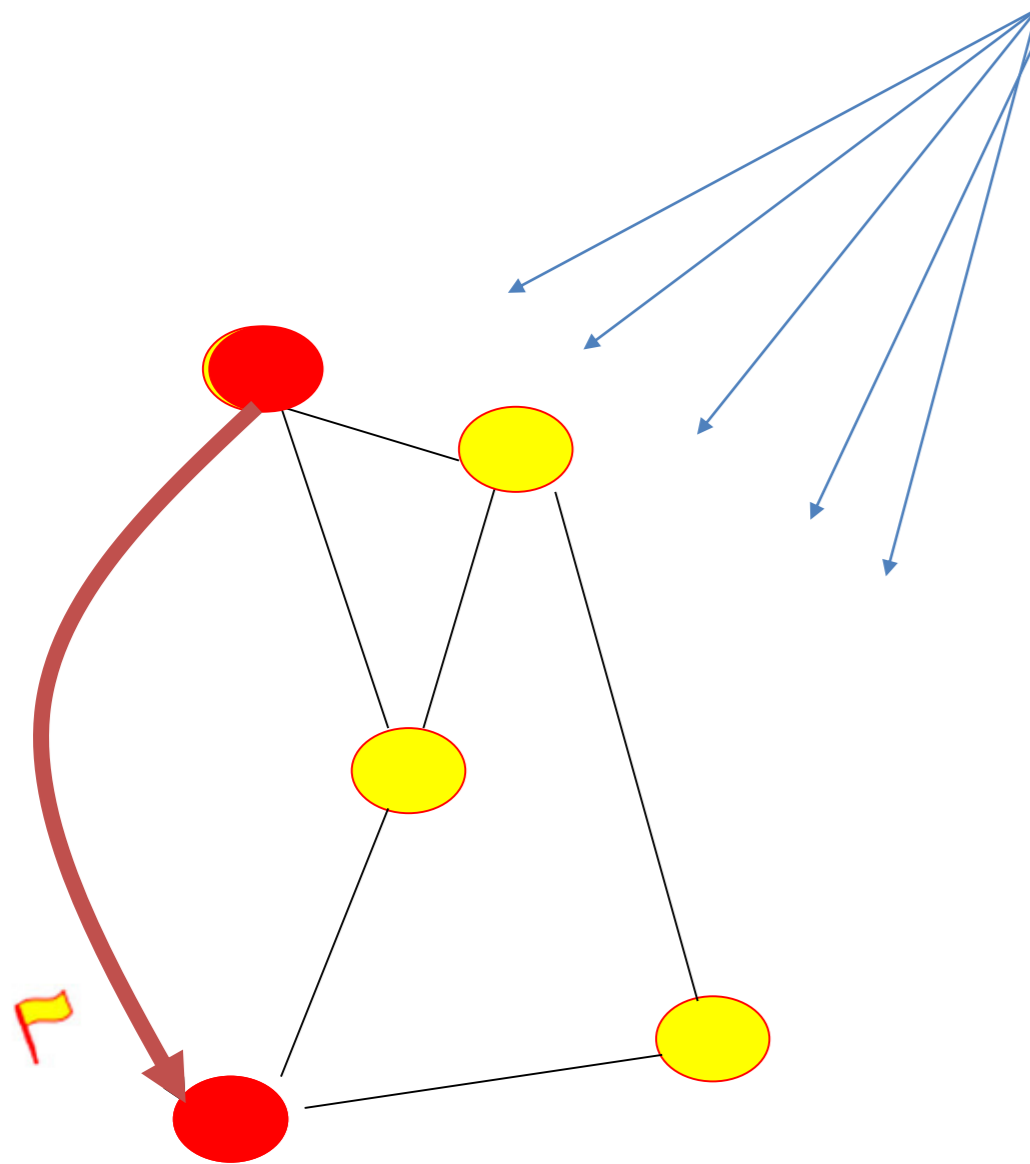

Step 1: co-activation sets eligibility trace

Step 2: eligibility trace decays over time

Step 3: delayed neuro-Modulator:
eligibility trace translated into weight change

Previous slide.

three-factor learning rules are a theoretical concept.

But are there any experiments? Only quite recently, a few experimental results were published that directly address this question.

3. Three-factor rules in striatum: eligibility trace and delayed DA

Yagishita et al. 2014

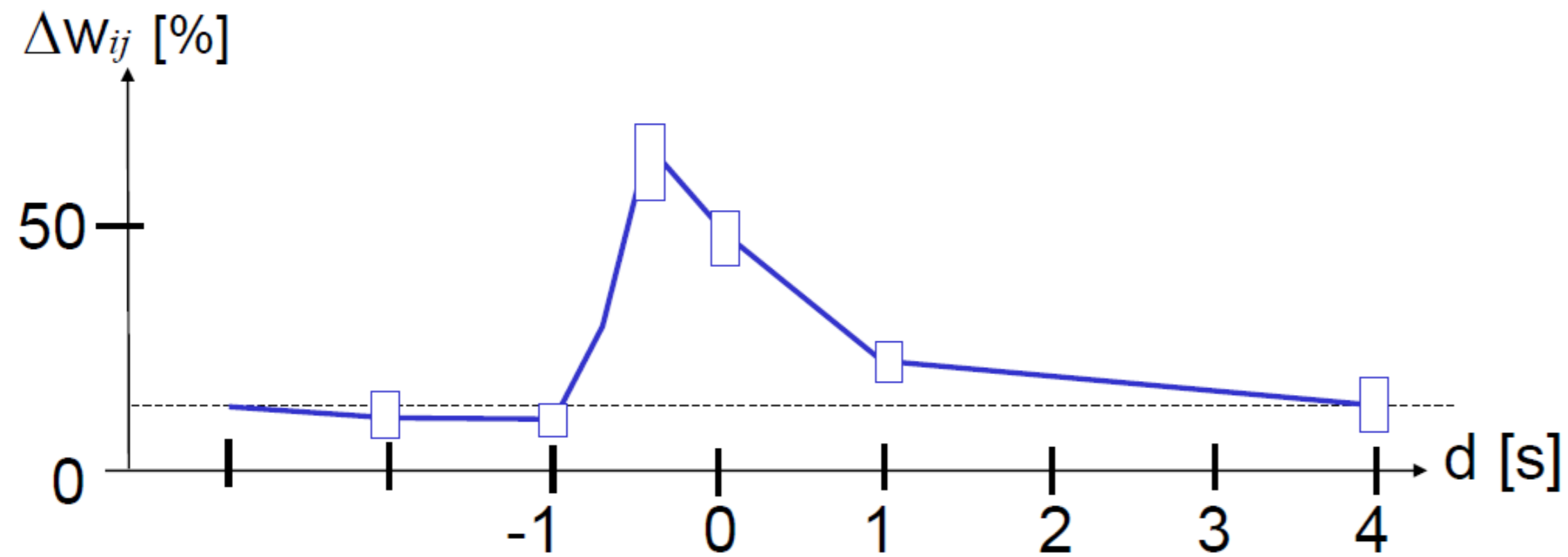

Reminder:
Striatum involved
in action selection

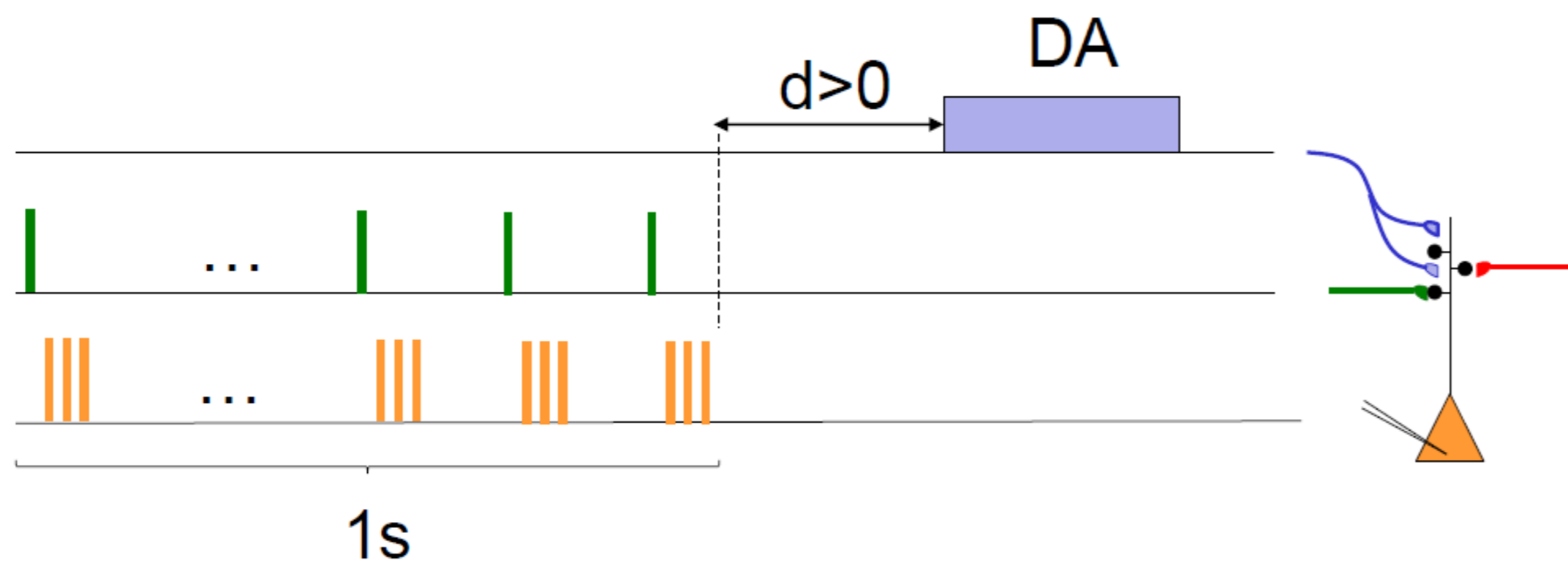

- Dopamine (DA) can come with a delay of 1s
- Long-Term stability over at least 50 min.

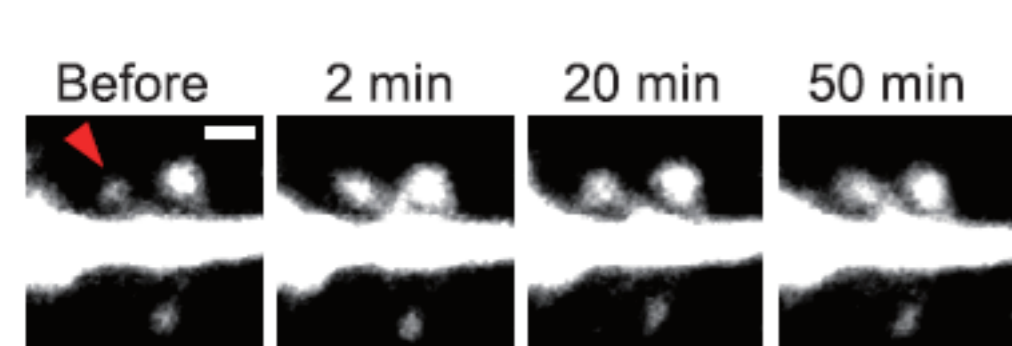

@457 nm, 30 Hz x 10

3. Three-factor rules in striatum: eligibility trace and delayed Da

Yagishita et al. 2014

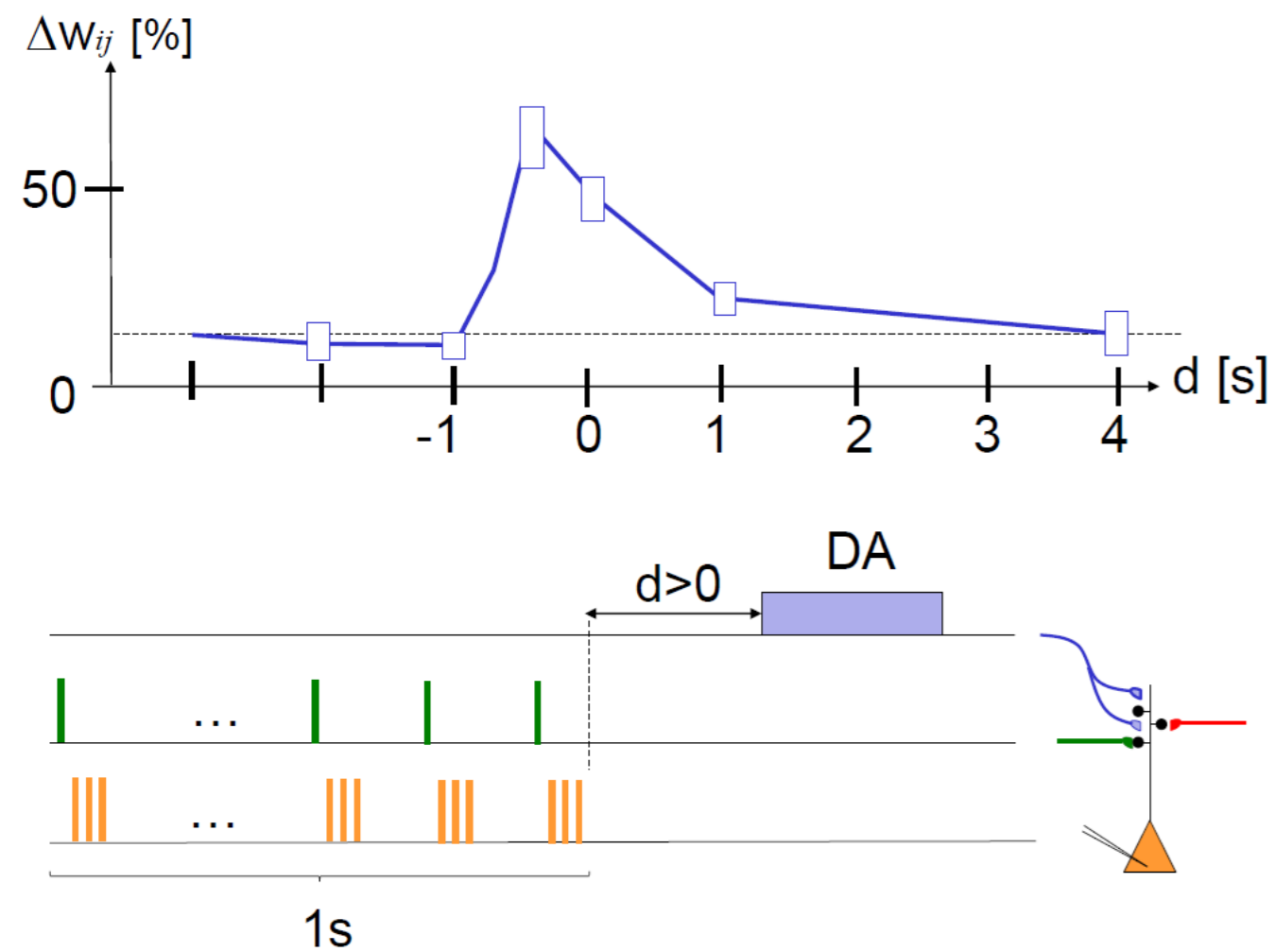

In striatum medial spiny cells, stimulation of presynaptic glutamatergic fibers (green) followed by three postsynaptic action potentials (STDP with pre-post-post-post at +10ms) repeated 10 times at 10Hz yields LTP if dopamine (DA) fibers are stimulated during the presentation ($d < 0$) or shortly afterward ($d = 0$ s or $d = 1$ s) but not if dopamine is given with a delay $d = 4$ s; redrawn after Fig. 1 of (Yagishita et al., 2014), with delay d defined as time since end of STDP protocol.

Lower left: the image from the beginning of this lecture comes from this experiment of Yagishita. This image demonstrates the Long-Term Stability over at least 50 min

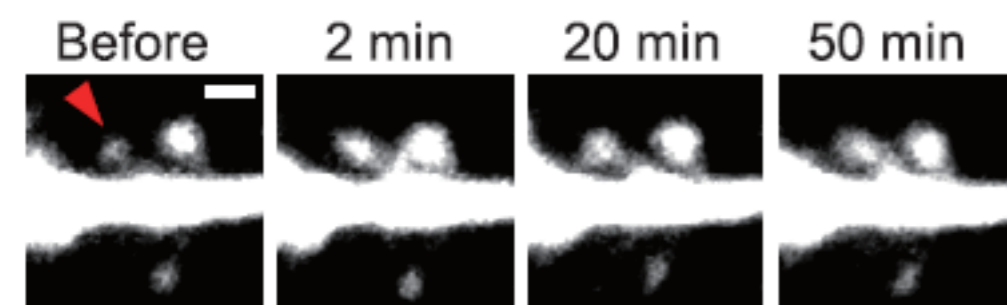

@457 nm, 30 Hz x 10

3. Three-factor rules in cortex: eligibility trace and delayed NE

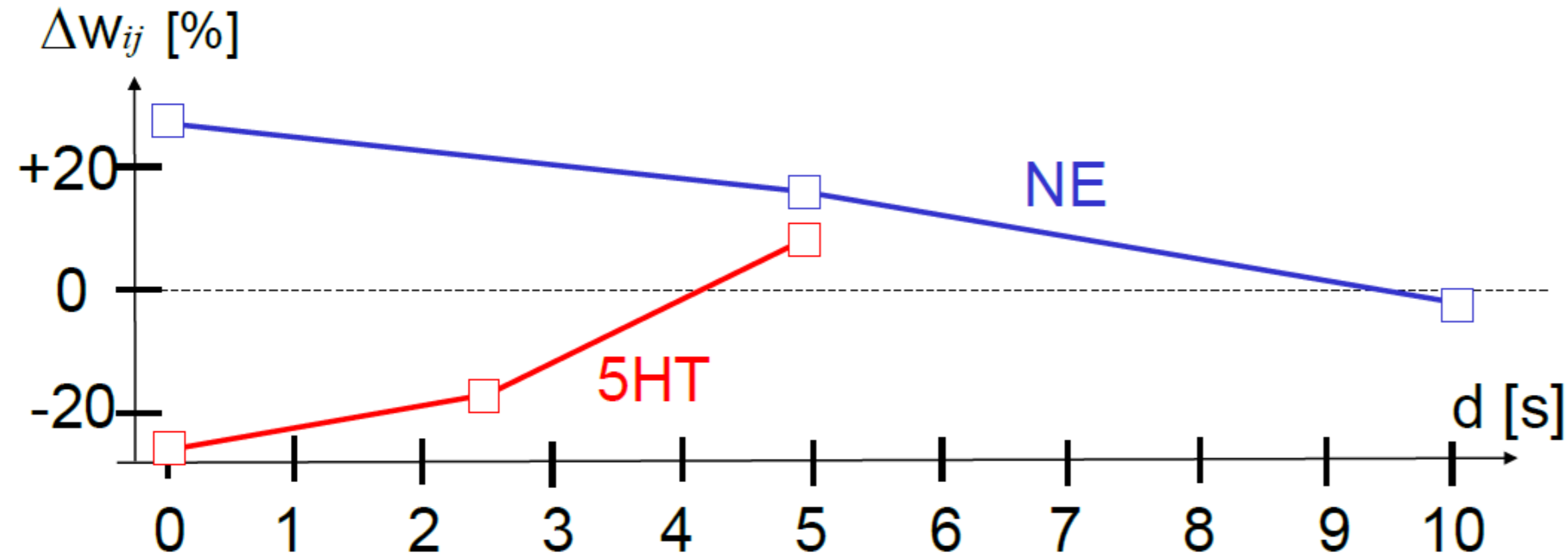

(He et al., 2015).

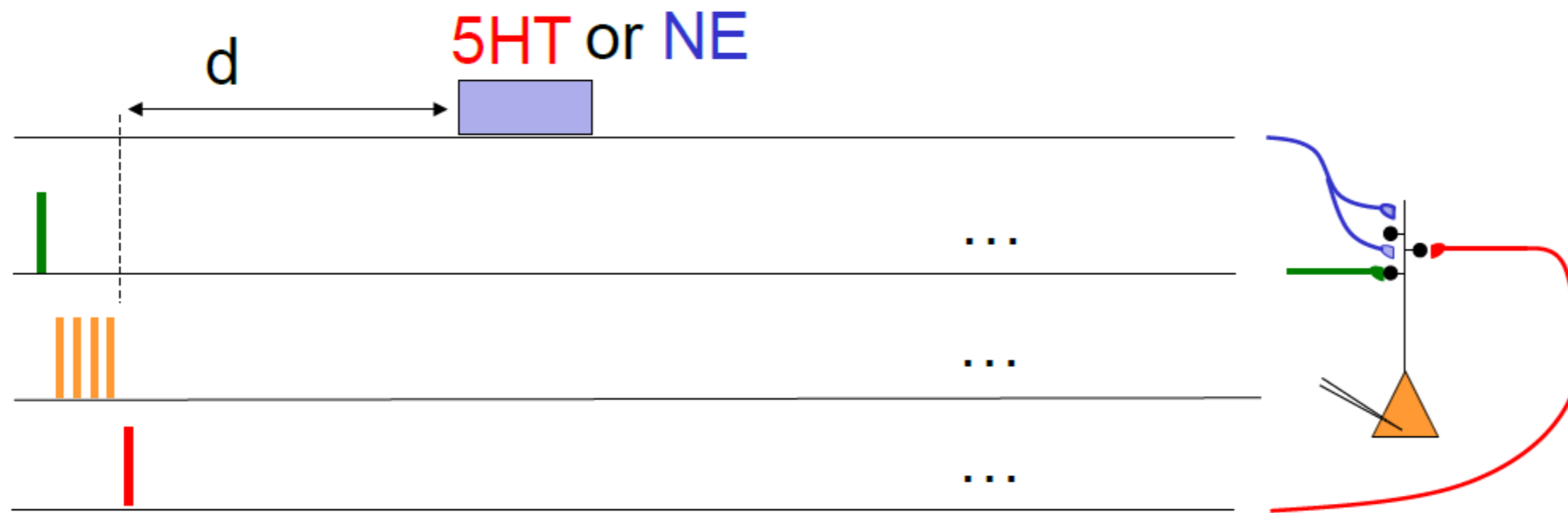

3. Not shown in class: second example

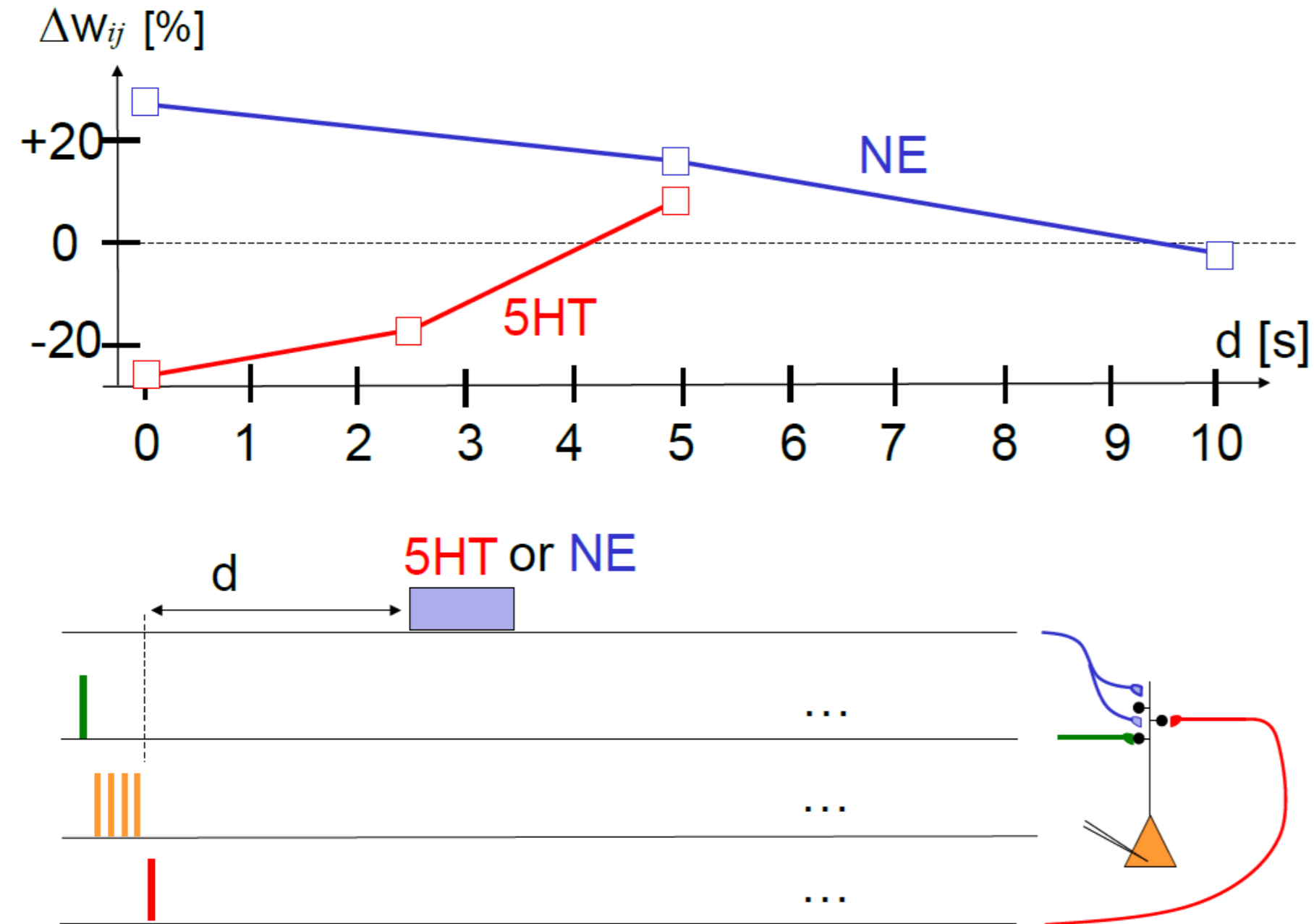

In cortical pyramidal cells, stimulation of two independent presynaptic pathways (green and red) from layer 4 to layer 2/3 by a single pulse is paired with a burst of four postsynaptic spikes (orange).

If the pre-before-post stimulation was combined with a pulse of norepinephrine (NE) receptor agonist isoproterenol with a delay of 0 or 5s, the protocol gave LTP (blue trace).

If the post-before-pre stimulation was combined with a pulse of serotonin (5-HT) of a delay of 0 or 2.5s, the protocol gave LTD (red trace).

(He et al., 2015).

3. Three-factor rules: summary

Three factors are needed for synaptic changes:

- Presynaptic factor = spikes of presynaptic neuron
or the effect of spike arrival at the synapse
- Postsynaptic factor = spikes of postsynaptic neuron
or increased voltage or a function of both
- Third factor = Neuromodulator such as dopamine

Previous slide.

three-factor learning rules are a theoretical concept.

But recent experiments show that the brain really can implement three-factor rules. Importantly, the third factor (neuromodulator) can come with a delay of one or two seconds after the Hebbian induction protocol that sets the eligibility trace. Minimal delays work better than longer delays.

Quiz. Synaptic Plasticity and Learning Rules

Standard Long-term potentiation

- [] has an acronym LTP
- [] takes more than 10 minutes to induce
- [] lasts more than 30 minutes
- [] depends on presynaptic activity
AND on state of postsynaptic neuron

Learning rules in the brain

- [] Hebbian learning depends on presynaptic activity
AND on state of postsynaptic neuron
- [] Reinforcement learning depends on neuromodulators
such as dopamine indicating reward (or TD error)
- [] Three-factor rule: presynaptic signal, postsynaptic
signal, and neuromodulator signal (e.g., DA) MUST
arrive at the same time.

Previous slide.

Your comments.

Wulfram Gerstner

EPFL, Lausanne, Switzerland

Reinforcement Learning and the Brain:

Three-factor learning rules and 'brain-style' computing

1. Coarse Brain Anatomy
2. Synaptic Plasticity
3. Three-factor Learning Rules
4. **Policy Gradient with Eligibility Traces Revisited**

Previous slide.

I now want to show that reinforcement learning with policy gradient gives rise to three-factor learning rules.

Learning Rules

3-factor
learning
rules

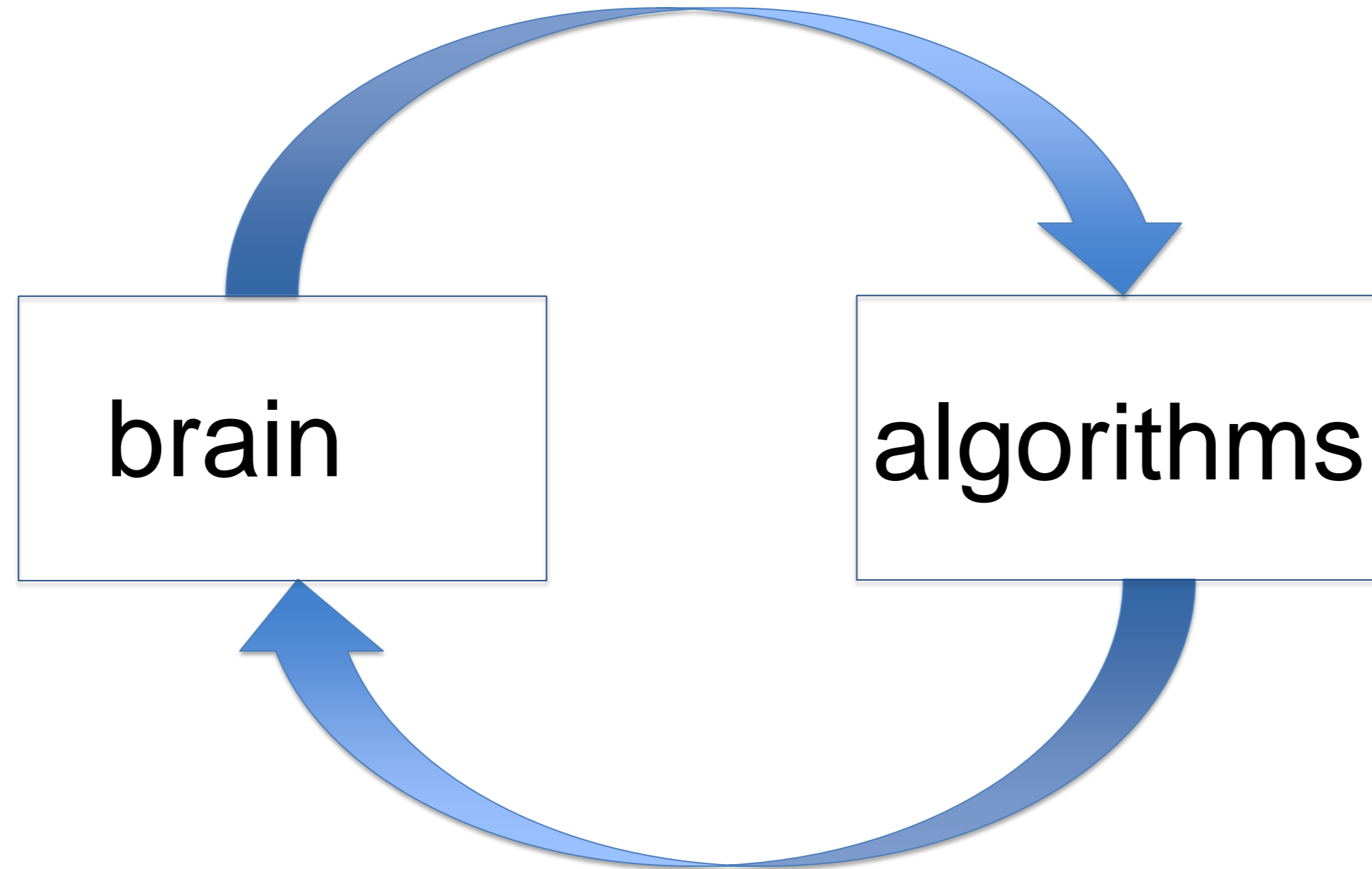

Advantage
Actor-Critic with
eligibility traces

Previous slide.

We will now compare the learning rule of the advantage actor critic with eligibility traces to the three-factor rules of the brain.

We bring together the actor-critic with eligibility traces and the results of exercise 1 today.

4. Eligibility traces from Policy Gradient (Exercise today)

Run episode.

At each time step, observe state s_t , action a_t , reward r_t

1) Update eligibility trace

$$z_k \leftarrow z_k \lambda \quad \text{decay of **all** traces}$$

$$z_k \leftarrow z_k + \frac{d}{dw_k} \ln[\pi(a_t | s_t, w_k)] \quad \text{increase of **all** traces}$$

2) update parameters: Two variants

Variant A $\Delta w_k = \eta r_t z_k \rightarrow$ REINFORCE (w. elig. trace)

Variant B $\Delta w_k = \eta \delta_t z_k \rightarrow$ Actor-Critic (w. elig. trace)

Previous slide. repetition of the exercises from week 10 and Exercise of Today Leads to the algo on slide 7

Actor–Critic with Eligibility Traces (continuing), for estimating $\pi_{\theta} \approx \pi_*$

Input: a differentiable policy parameterization $\pi(a|s, \theta)$

Input: a differentiable state-value function parameterization $\hat{v}(s, \mathbf{w})$

Algorithm parameters: $\lambda^{\mathbf{w}} \in [0, 1]$, $\lambda^{\theta} \in [0, 1]$, $\alpha^{\mathbf{w}} > 0$, $\alpha^{\theta} > 0$

Initialize state-value weights $\mathbf{w} \in \mathbb{R}^d$ and policy parameter $\theta \in \mathbb{R}^{d'}$ (e.g., to $\mathbf{0}$)

Initialize $S \in \mathcal{S}$ (e.g., to s_0)

$\mathbf{z}^{\mathbf{w}} \leftarrow \mathbf{0}$ (d -component eligibility trace vector)

$\mathbf{z}^{\theta} \leftarrow \mathbf{0}$ (d' -component eligibility trace vector)

Loop forever (for each time step):

$A \sim \pi(\cdot|S, \theta)$

Take action A , observe S', r

$\delta \leftarrow r + \gamma \hat{v}(S', \mathbf{w}) - \hat{v}(S, \mathbf{w})$

$\mathbf{z}^{\mathbf{w}} \leftarrow \lambda^{\mathbf{w}} \mathbf{z}^{\mathbf{w}} + \nabla \hat{v}(S, \mathbf{w})$

$\mathbf{z}^{\theta} \leftarrow \lambda^{\theta} \mathbf{z}^{\theta} + \nabla \ln \pi(A|S, \theta)$

$\mathbf{w} \leftarrow \mathbf{w} + \alpha^{\mathbf{w}} \delta \mathbf{z}^{\mathbf{w}}$

$\theta \leftarrow \theta + \alpha^{\theta} \delta \mathbf{z}^{\theta}$

$S \leftarrow S'$

*Adapted from
Sutton and Barto*

4. Example: Linear activation model with softmax policy

left: $a_1=1$ stay: $a_2=1$ right: $a_3=1$

parameters

$$\pi(a_j = 1 | \vec{x}, \theta) = \text{softmax}\left[\sum_k w_{jk} y_k\right]$$

$$y_k = f(\vec{x} - x_k)$$

f = basis function

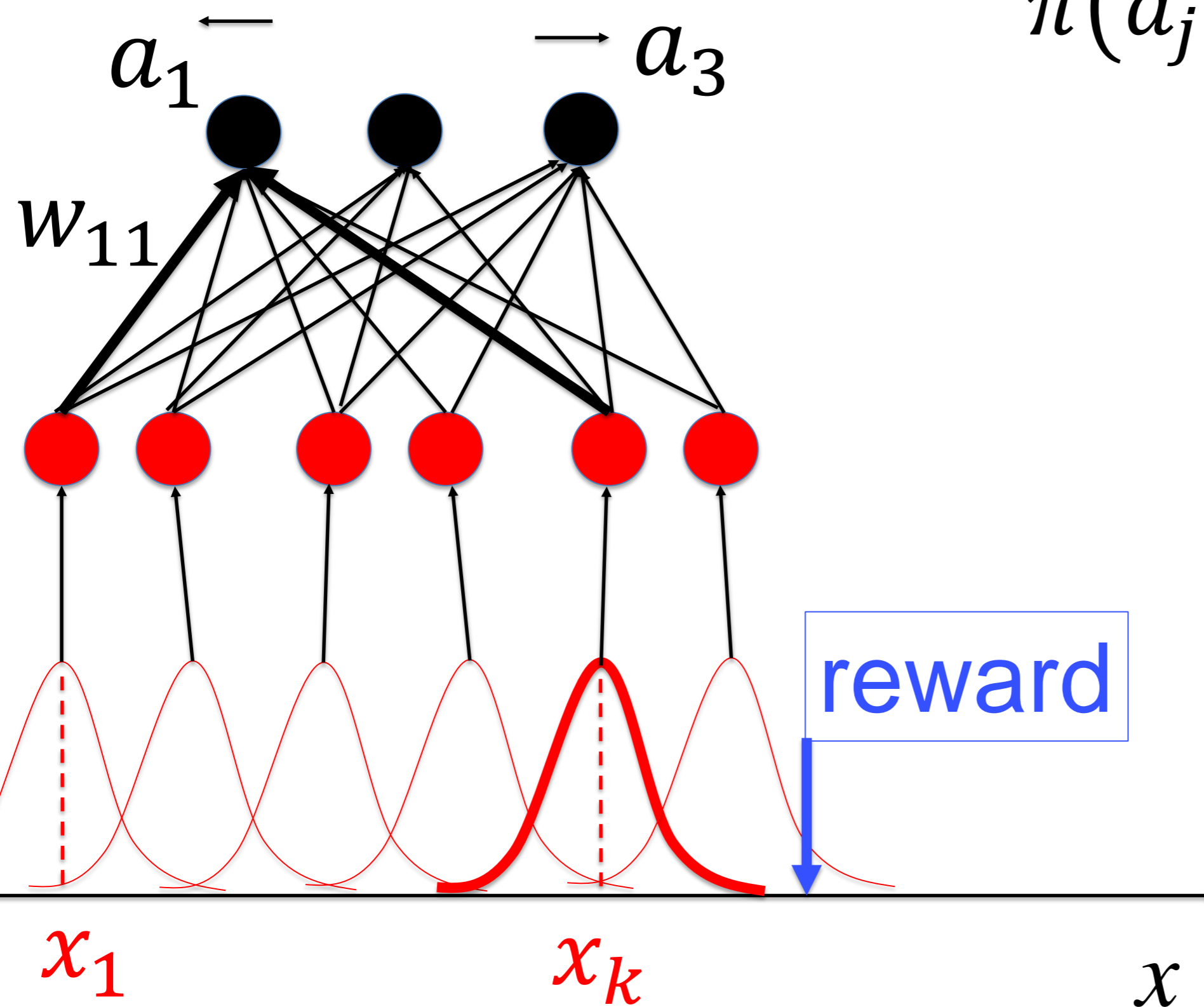

Previous slide.

Suppose the agent moves on a linear track.

There are three possible actions: left, right, or stay.

The policy is given by the softmax function. The total drive of the action neurons is a linear function of the activity y of the hidden neurons which in turn depends on the input x . The activity of hidden neuron k is $f(x-x_k)$. The basis function f could for example be a Gaussian function with center at x_k .

4. Review Exercise: Linear activation model with softmax policy

left: $a_1=1$ stay: $a_2=1$ right: $a_3=1$

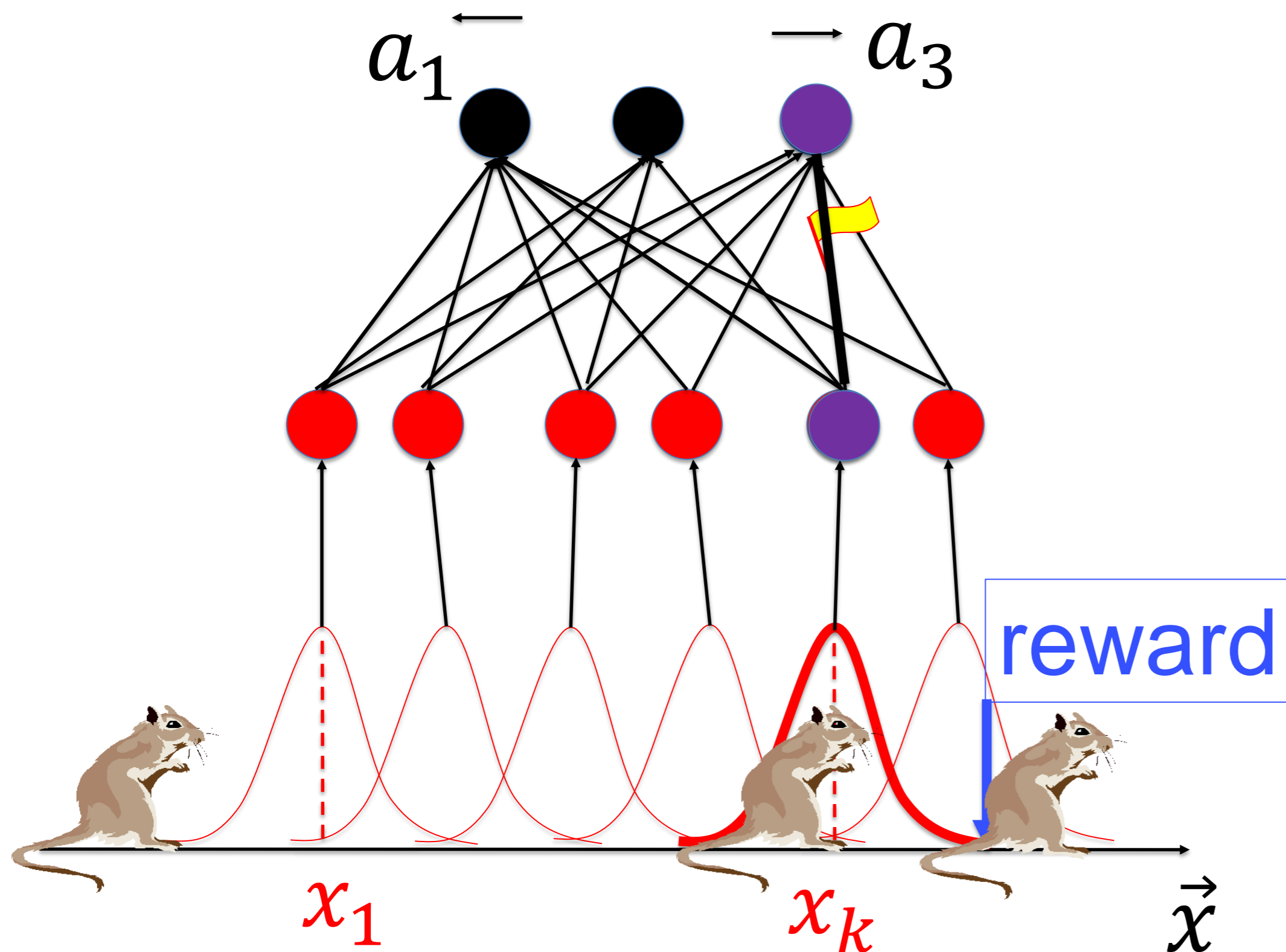

- 0) Choose action $a_i \in \{0,1\}$
- 1) Update eligibility trace

$$z_{ik} \leftarrow z_{ik} \lambda$$

$$z_{ik} \leftarrow z_{ik} + \frac{d}{dw_k} \ln[\pi(a_i^t = 1 | \vec{x})]$$

$$\Delta z_{ij} = \eta [a_i^t - \langle a_i(\vec{x}) \rangle] x_j$$

- 2) update weights

$$\Delta w_{lk} = \eta \delta_t z_{lk}$$

Already done in Exercise
 → Three-factor rule with
 eligibility traces

Previous slide.

This is the result of the in-class exercise (Exercise 1 of this week).

Importantly, the update of the eligibility trace is a local learning rule that depends on a presynaptic factor and a postsynaptic factor.

The reward is the third factor and has no indices (since it acts as a global factor, broadcasted to all neurons and synapses).

$$\Delta z_{ij} = \eta [a_i^t - \langle a_i(\vec{x}) \rangle] x_j$$

4. Summary: 3-factor rules derived from Policy Gradient

- Policy gradient with one hidden layer and linear softmax readout yields a 3-factor rule
- Eligibility trace is set by joint activity of presynaptic and postsynaptic neuron
- Update happens proportional to the eligibility trace and to either reward r (REINFORCE) or TD error (Adv. Actor-Critic)
- **The presynaptic neuron represents the state**
- **The postsynaptic neuron the action**
- True online rule
 - could be implemented in biology
 - can also be implemented in parallel asynchr. Hardware
 - non-von-Neumann compute paradigm

Previous slide.

Summary: A policy gradient algorithm in a network where the output layer has a linear drive with softmax output leads to a three-factor learning rule for the connections between neurons in the hidden layer and the output.

These three factor learning rules are important because they are completely asynchronous, local, and online and could therefore be implemented in biology or parallel hardware.

The global modulator could present either the reward r directly (in the style of the REINFORCE algorithm); or it could present the TD error (which yields an interpretation as advantage actor-critic).

Which one of the two possibilities would fit the dopamine signal?

This is the next question

Learning Rules

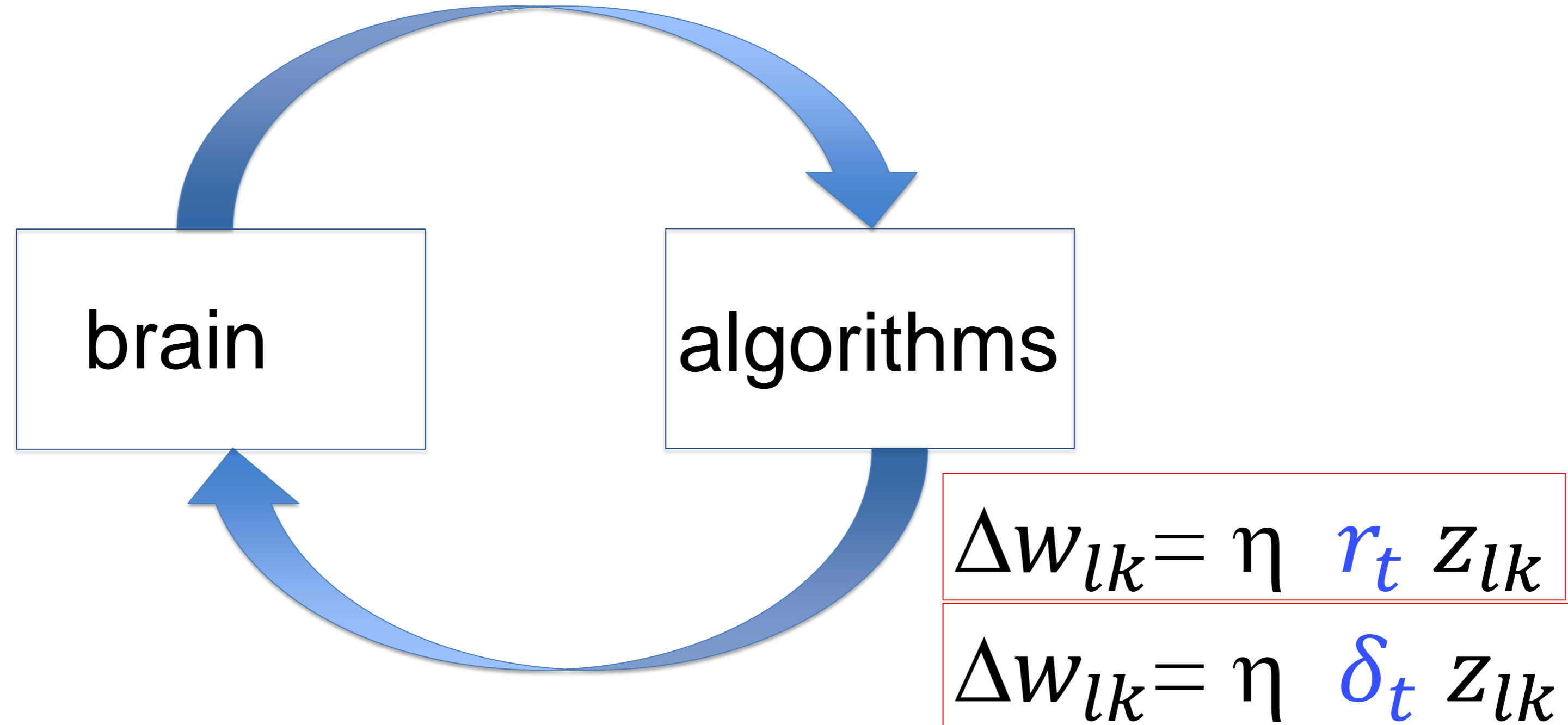

The learning rule of the (advantage) actor-critic or REINFORCE with eligibility traces are both compatible with three-factor rules

Updates proportional to the reward r or TD error δ_t

Review: Advantage Actor-Critic with Eligibility traces

Actor–Critic with Eligibility Traces (continuing), for estimating $\pi_{\theta} \approx \pi_*$

Input: a differentiable policy parameterization $\pi(a|s, \theta)$

Input: a differentiable state-value function parameterization $\hat{v}(s, \mathbf{w})$

Algorithm parameters: $\lambda^{\mathbf{w}} \in [0, 1]$, $\lambda^{\theta} \in [0, 1]$, $\alpha^{\mathbf{w}} > 0$, $\alpha^{\theta} > 0$

Initialize state-value weights $\mathbf{w} \in \mathbb{R}^d$ and policy parameter $\theta \in \mathbb{R}^{d'}$ (e.g., to $\mathbf{0}$)

Initialize $S \in \mathcal{S}$ (e.g., to s_0)

$\mathbf{z}^{\mathbf{w}} \leftarrow \mathbf{0}$ (d -component eligibility trace vector)

$\mathbf{z}^{\theta} \leftarrow \mathbf{0}$ (d' -component eligibility trace vector)

Loop forever (for each time step):

$A \sim \pi(\cdot|S, \theta)$

Take action A , observe S', r

$\delta \leftarrow r + \gamma \hat{v}(S', \mathbf{w}) - \hat{v}(S, \mathbf{w})$

← TD signal

$\mathbf{z}^{\mathbf{w}} \leftarrow \lambda^{\mathbf{w}} \mathbf{z}^{\mathbf{w}} + \nabla \hat{v}(S, \mathbf{w})$

$\mathbf{z}^{\theta} \leftarrow \lambda^{\theta} \mathbf{z}^{\theta} + \nabla \ln \pi(A|S, \theta)$

$\mathbf{w} \leftarrow \mathbf{w} + \alpha^{\mathbf{w}} \delta \mathbf{z}^{\mathbf{w}}$

$\theta \leftarrow \theta + \alpha^{\theta} \delta \mathbf{z}^{\theta}$

$S \leftarrow S'$

*Adapted from
Sutton and Barto*

5. Combine Eligibility Traces with TD in Advantage Actor-Critic

Idea:

- keep memory of previous 'candidate updates'
- memory decays over time
- Update an **eligibility trace for each parameter**

$$z_k \leftarrow z_k \lambda \quad \text{decay of **all** traces}$$

$$z_k \leftarrow z_k + \frac{d}{dw_k} \ln[\pi(a|s, w_k)] \quad \text{increase of **all** traces}$$

- update **all** parameters:

$$\Delta w_k = \eta \underbrace{[r - (V(s) - \gamma V(s'))]}_{\text{TD-delta}} z_k$$

→ policy gradient with eligibility trace and TD error

Previous slides.

As a reminder (not shown in class). Review of algorithm with actor-critic architecture and policy gradient with eligibility traces and TD.

Learning Rule for Advantage Actor Critic

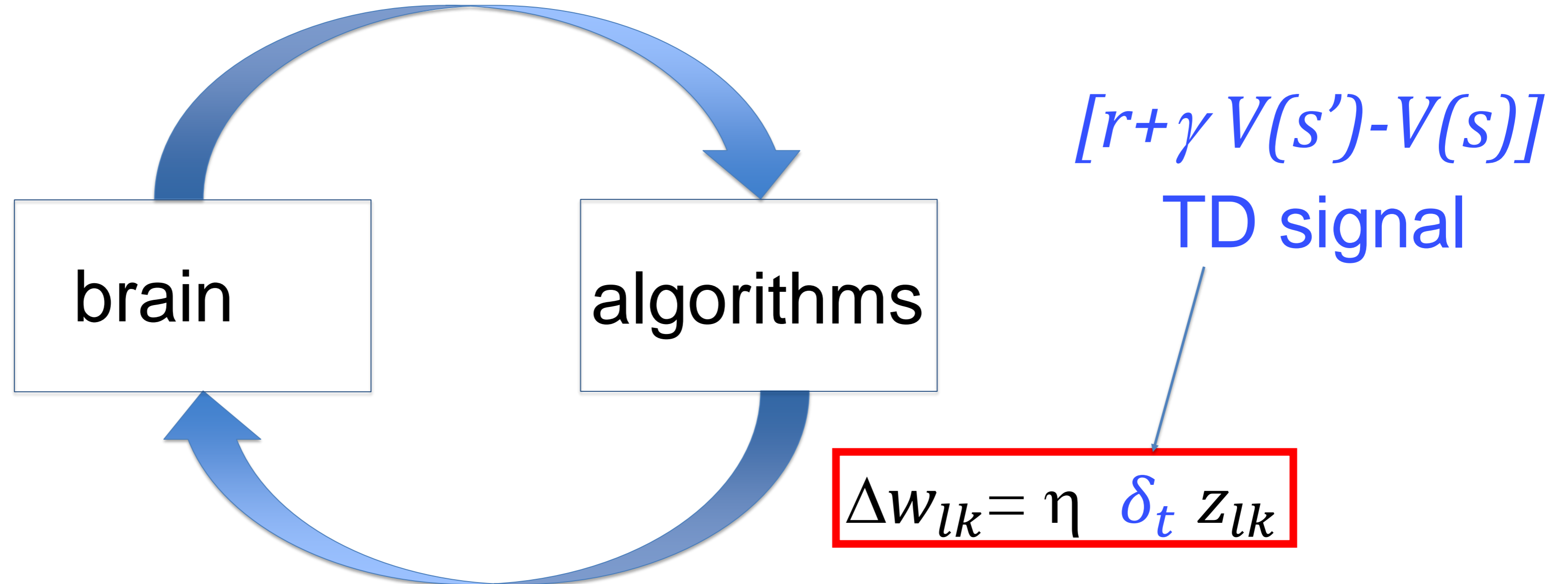

The learning rule of the **advantage** actor-critic with eligibility traces

is consistent with a brain-like three-factor rule

Condition: the brain can broad-cast a TD signal!

Previous slide.

The main difference between standard REINFORCE with eligibility traces and the Advantage Actor Critic is that in the advantage actor-critic the global modulator represents the TD error whereas it represents the immediate reward for REINFORCE.

Both would be compatible with brain-like learning rules.

We now show that the TD signal is consistent with the dopamine signal!

Wulfram Gerstner

EPFL, Lausanne, Switzerland

Reinforcement Learning and the Brain:

Three-factor learning rules and 'brain-style' computing

1. Coarse Brain Anatomy
2. Synaptic Plasticity
3. Three-factor Learning Rules
4. Policy Gradient with Eligibility Traces Revisited
5. **Dopamine as a Third Factor is a TD-like signal**

Previous slide.

So far the third factor remained rather abstract. We mentioned that a neuromodulator such as dopamine could be involved. Let us make this idea more precise and show experimental data.

5. Neuromodulators as Third factor

Three factors are needed for synaptic changes:

- Presynaptic factor = spikes of presynaptic neuron
- Postsynaptic factor = spikes of postsynaptic neuron
or increased voltage
- Third factor = Neuromodulator such as dopamine

Presynaptic and postsynaptic factor 'select' the synapse.

→ a small subset of synapses becomes 'eligible' for change.

The 'Third factor' is a nearly global signal

→ broadcast signal, potentially received by all synapses.

Synapses need all three factors for change

Previous slide.

Before we start let us review the basics of a three-factor learning rule. We said that the third factor could be a neuromodulator such as dopamine.

Review: Reward information

Neuromodulator **dopamine**: - is nearly globally broadcasted
- signals reward minus expected reward

‘success signal’

Schultz et al., 1997,
Waelti et al., 2001
Schultz, 2002

Dopamine

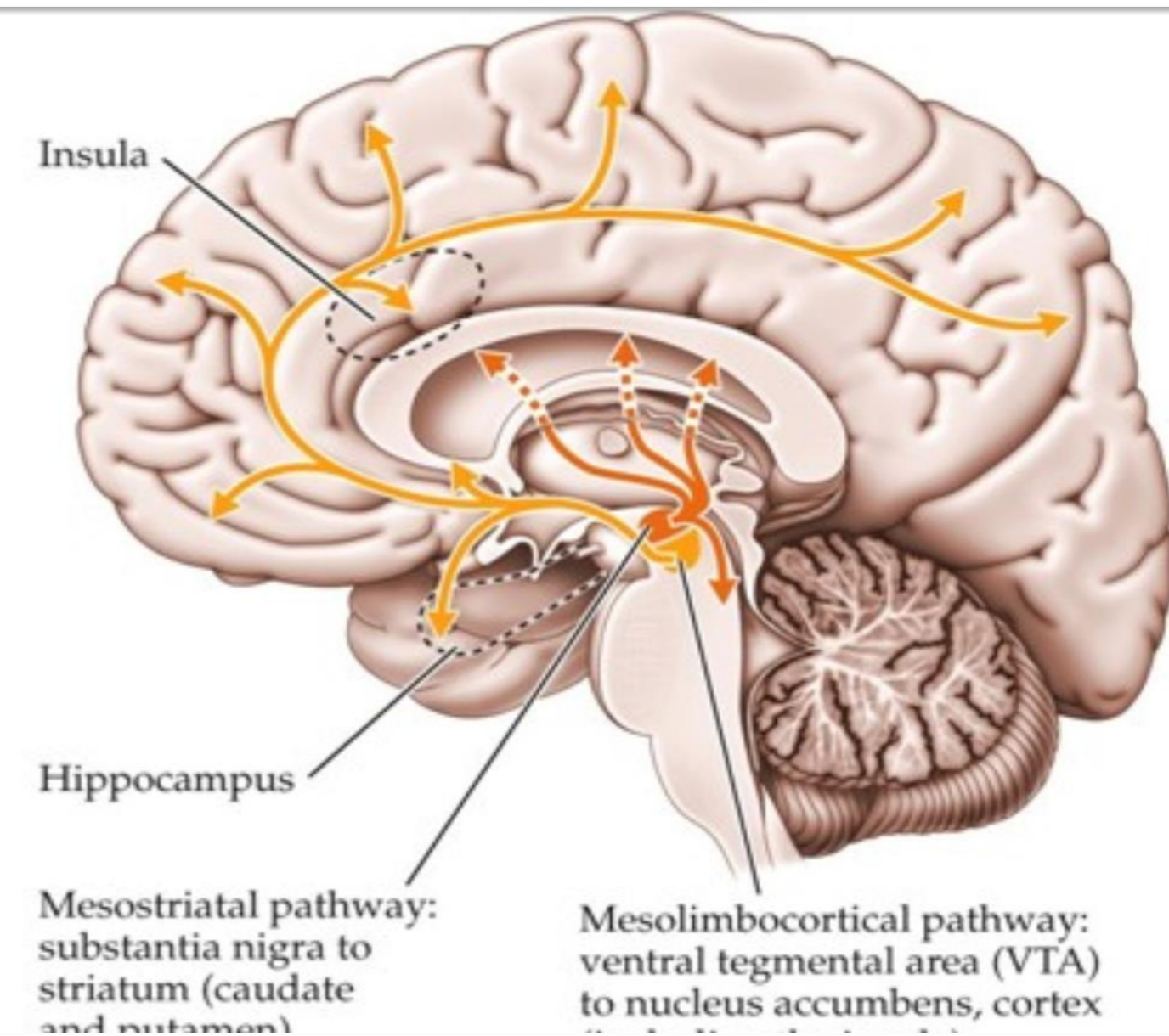

Previous slide. Dopamine neurons send dopamine signals to many neurons and synapses in parallel in a broadcast like fashion.

5. Dopamine as Third factor

Conditioning:

red light \rightarrow touch lever \rightarrow 1s \rightarrow reward

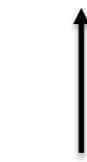

action

$r(t)$

CS:
Conditioning
Stimulus

$$DA(t) = \underbrace{[r(t) + \gamma V(s') - V(s)]}_{\text{TD-delta}}$$

Sutton book, reprinted from W. Schultz
(1997, Science)

No prediction
Reward occurs

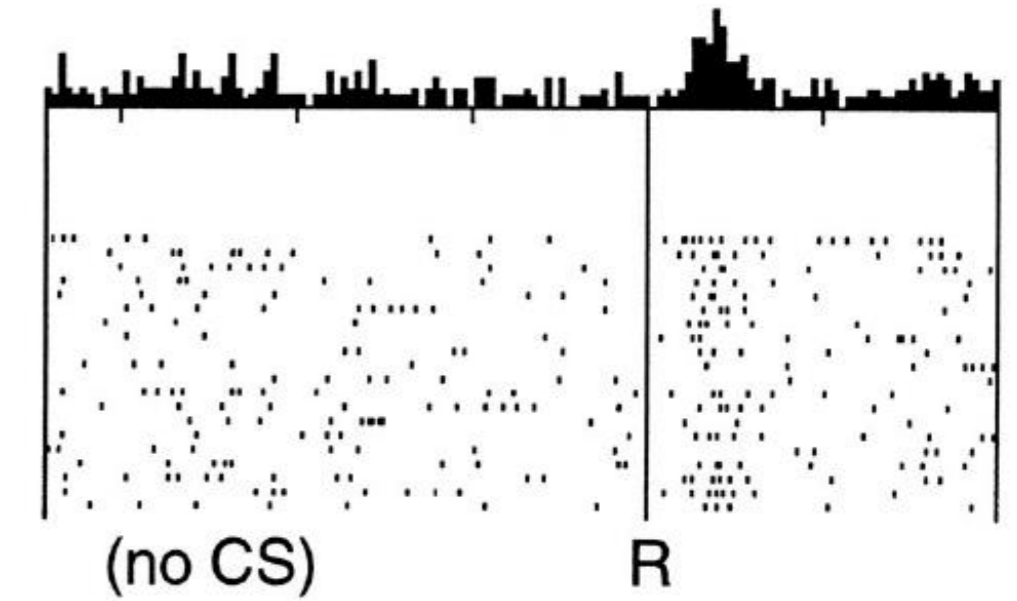

Reward predicted
Reward occurs

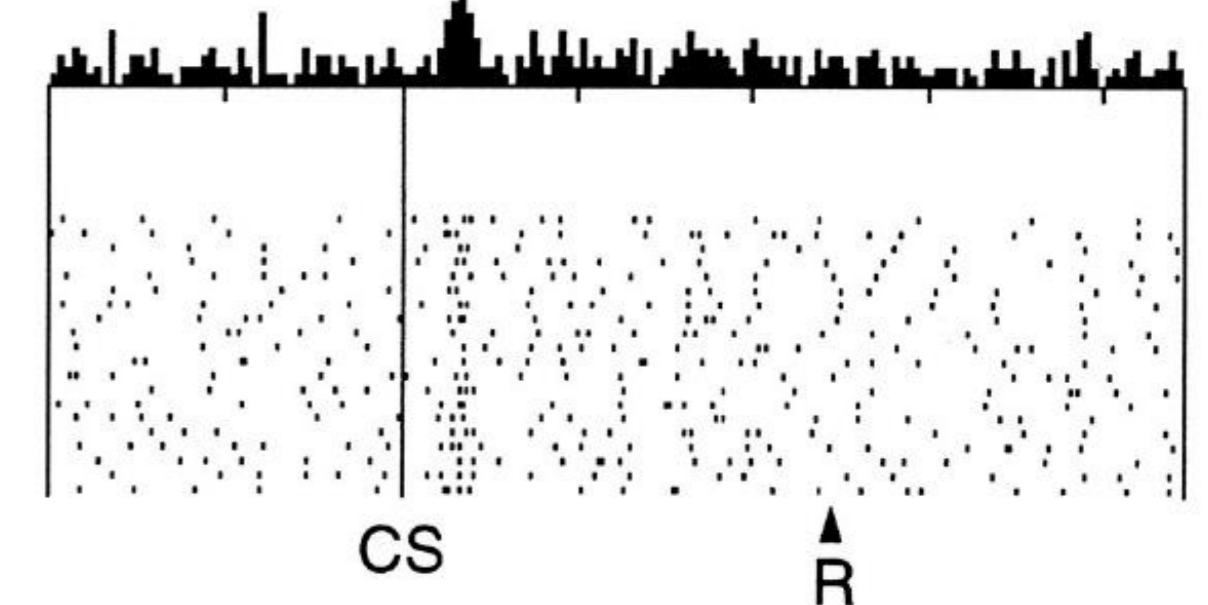

Reward predicted
No reward occurs

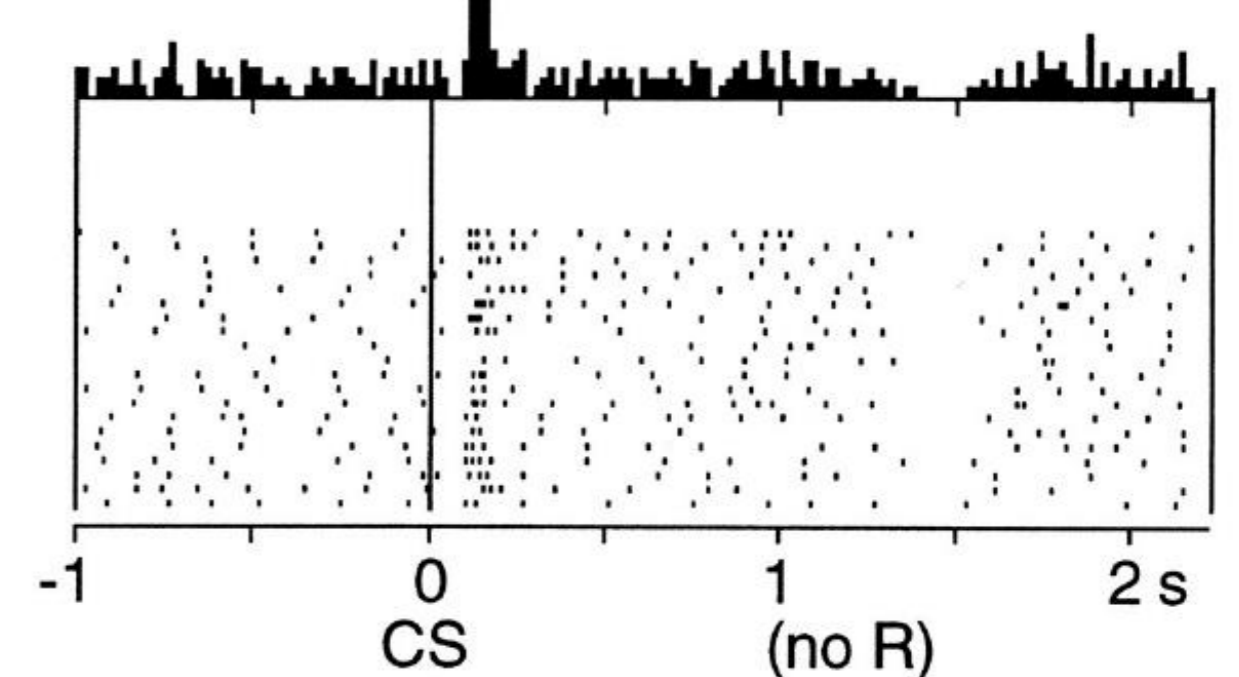

5. Dopamine as Third factor

This is now the famous experiment of W. Schultz.

In reality the CS was not a red light, but that does not matter

Figure 15.3: The response of dopamine neurons drops below baseline shortly after the time when an expected reward fails to occur. Top: dopamine neurons are activated by the unpredicted delivery of a drop of apple juice. Middle: dopamine neurons respond to a conditioned stimulus (CS) that predicts reward and do not respond to the reward itself. Bottom: when the reward predicted by the CS fails to occur, the activity of dopamine neurons drops below baseline shortly after the time the reward is expected to occur. At the top of each of these panels is shown the average number of action potentials produced by monitored dopamine neurons within small time intervals around the indicated times. The raster plots below show the activity patterns of the individual dopamine neurons that were monitored; each dot represents an action potential. From Schultz, Dayan, and Montague, *A Neural Substrate of Prediction and Reward*, *Science*, vol. 275, issue 5306, pages 1593-1598, March 14, 1997. Reprinted with permission from AAAS.

No prediction
Reward occurs

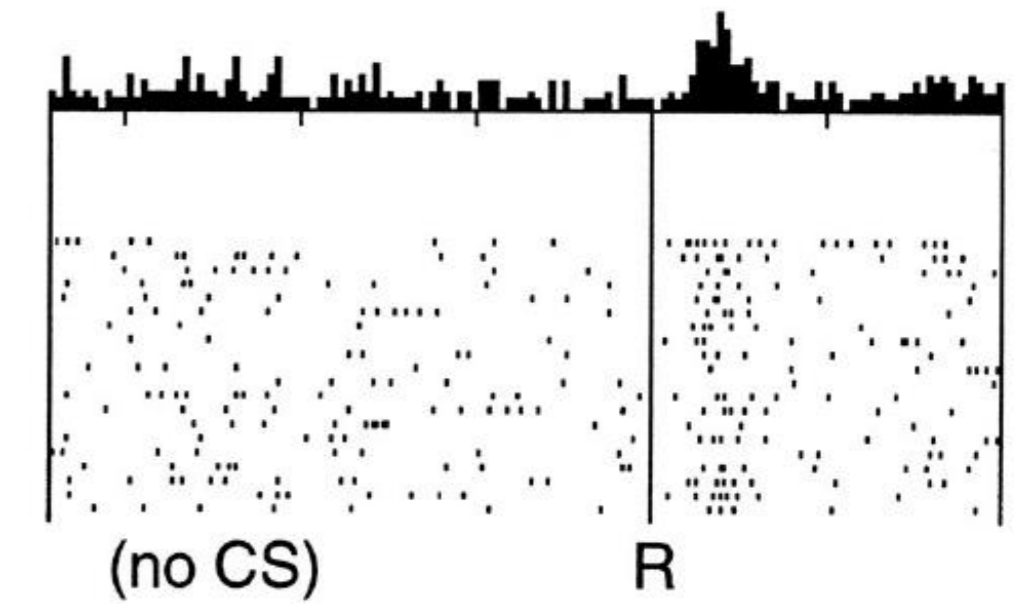

Reward predicted
Reward occurs

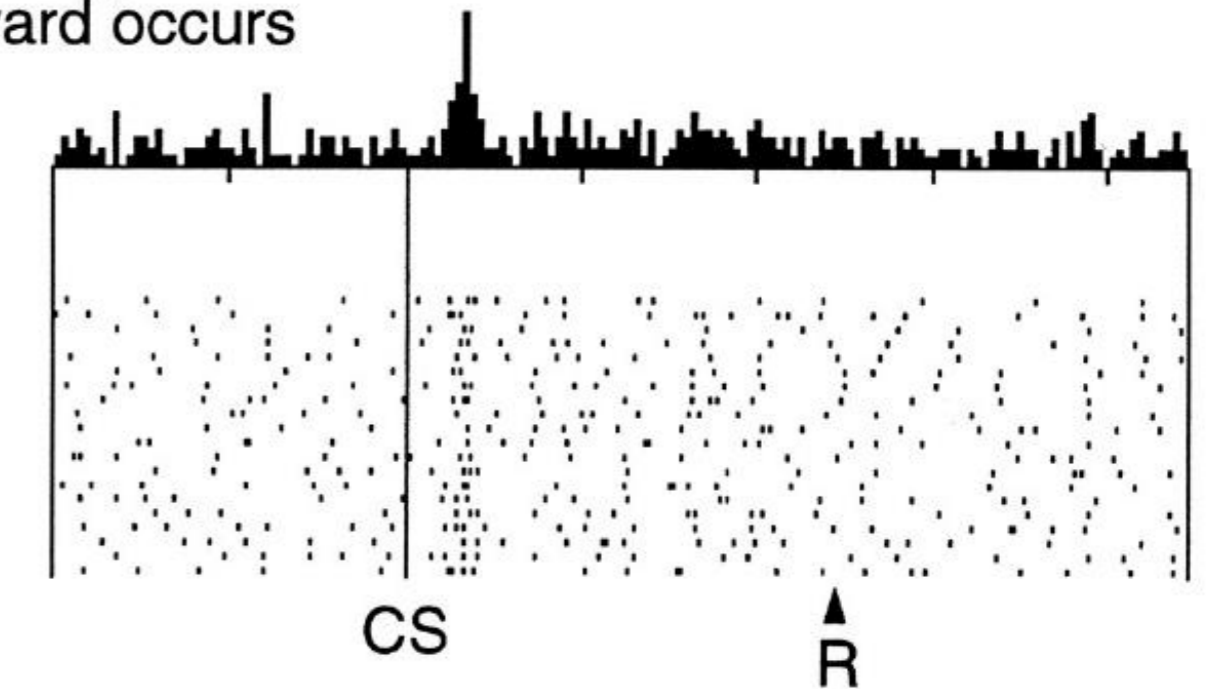

Reward predicted
No reward occurs

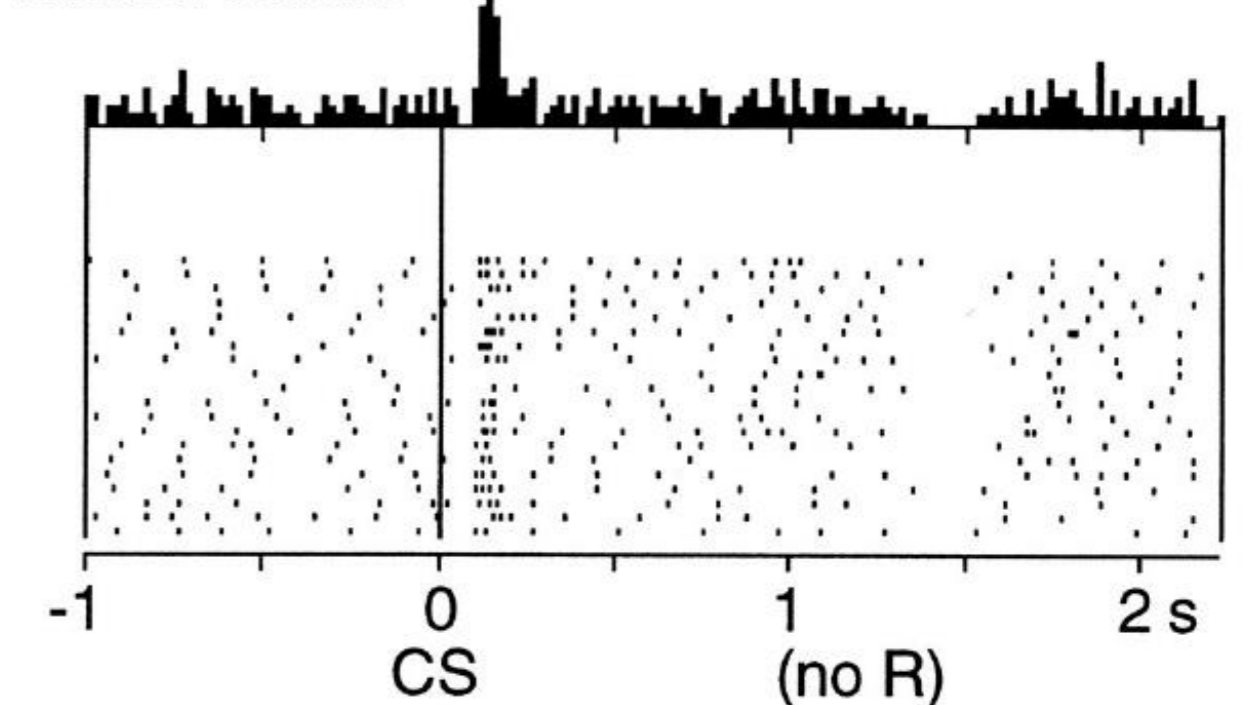

5. Summary: Dopamine as Third factor

- Dopamine signals 'reward minus expected reward'
- Dopamine signals an 'event that predicts a reward'
- Dopamine signals approximately the TD-error

$$DA(t) = \underbrace{[r(t) + \gamma V(s') - V(s)]}_{\text{TD-delta}}$$

Previous slide.

The paper of W. Schultz has related the dopamine signal to some basic aspects of Temporal difference Learning. The Dopamine signal is similar to the TD error.

5. Application: Advantage Actor-Critic = update with TD signal

- Estimate $V(s)$
- learn via TD error

actions

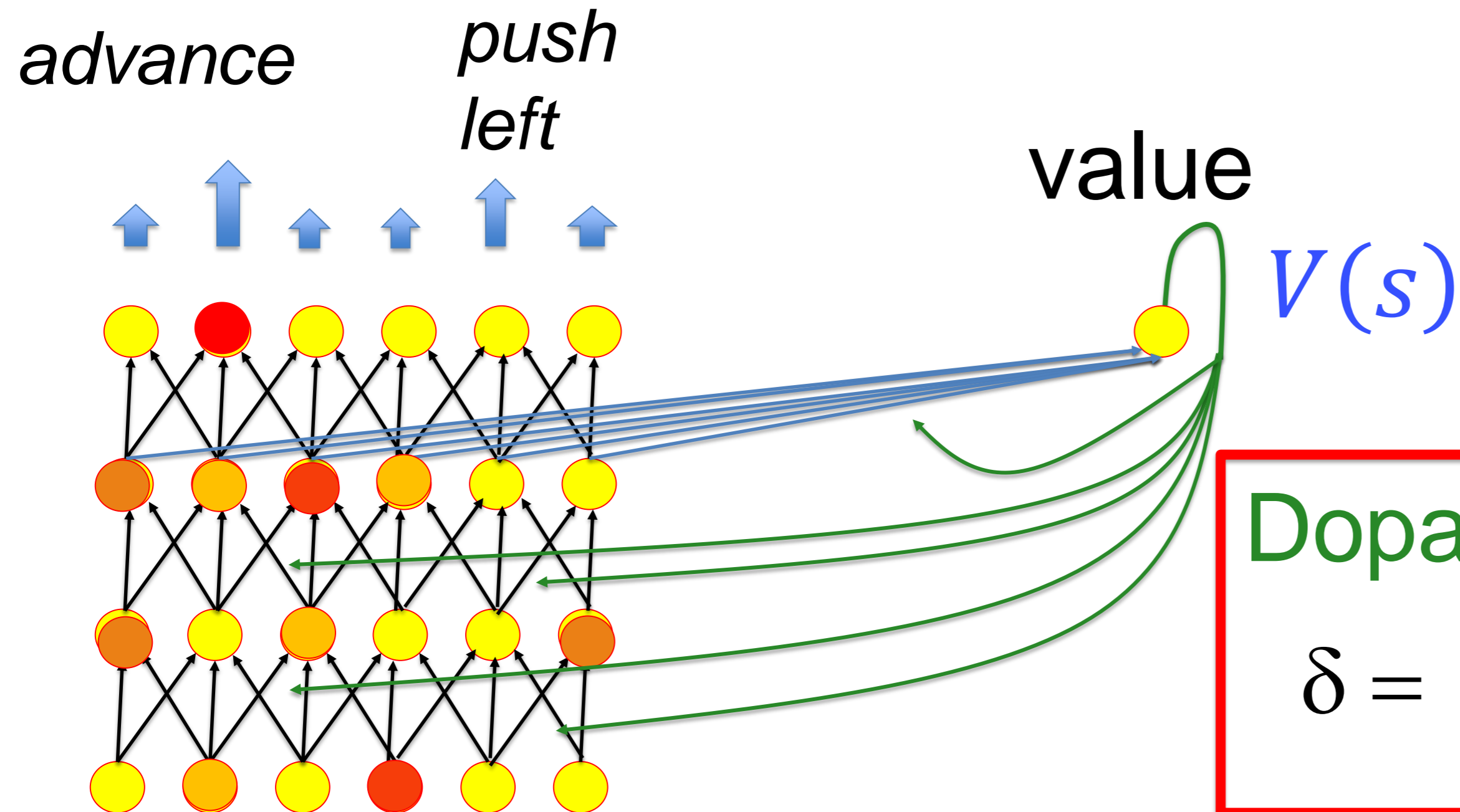

Dopamine = TD-error

$$\delta = [r_t + \gamma V(s') - V(s)]$$

Previous slide.

Review of actor-critic architecture

5. Summary: Eligibility Traces with TD in Actor-Critic

Three-factor rules:

Presynaptic and postsynaptic factor 'select' the synapse.

→ a small subset of synapses becomes 'eligible' for change.

The 'Third factor' is a nearly global broadcast signal

→ potentially received by all synapses.

Synapses need all three factors for change

The 'Third factor' can be the Dopamine-like TD signal

→ Need actor-critic architecture to calculate $\gamma V(s') - V(s)$

→ Dopamine signals $[r_t + \gamma V(s') - V(s)]$

Previous slide.

The three factor rule, dopamine, TD signals, value functions now all fit together.

Action of dopamine

(from paper by W. Schultz et al. 1997)

- drugs like amphetamine and cocaine exert their **addictive** actions in part by prolonging the influence of dopamine on target neurons. Heroin and Cannabis increase dopamine concentration in nucleus accumbens.
- rats press bars to excite dopamine neurons via an implanted electrode. The rats often choose these 'apparently rewarding' stimuli over food and sex.
- animals treated with dopamine receptor blockers learn less rapidly to press a bar for a reward pellet.

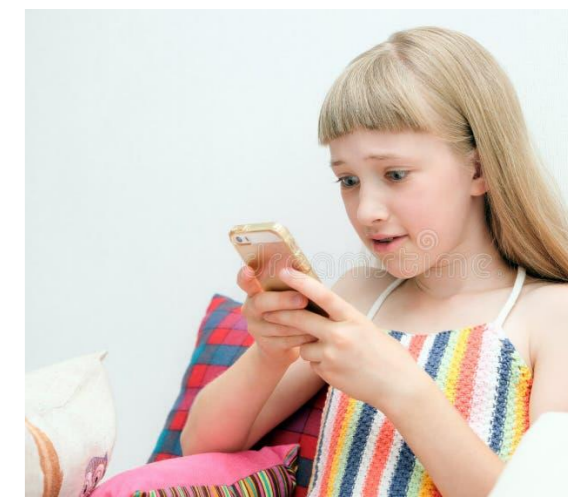
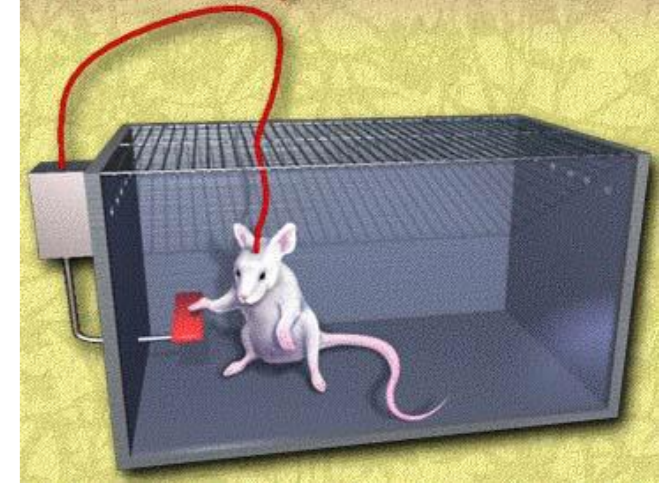

Previous slide.

Dopamine is an important molecule, one of the neuromodulators. It is related to reward-based learning and closely linked to addiction.

Tanda, Pontieri, DiChiara

<https://www.science.org/doi/full/10.1126/science.276.5321.2048>

Dichiara et al, 2003

<https://www.sciencedirect.com/science/article/pii/S0028390804002199>

Self-stimulation:

Phillips and Fiebiger,

<https://psycnet.apa.org/record/1980-00546-001>

Dopamine and Motor learning

R.J. Beninger (1983)

<https://www.sciencedirect.com/science/article/pii/0165017383900383>

5. Summary: Dopamine as a Reinforcement Signal

Dopamine is a **brain-internal broadcast signal**

sometimes called '**intrinsic reward system**', triggered by

→ (extrinsic) reward: chocolate, sweet food, drugs,

.... for humans also: 'praise', money

→ not just reward: also 'surprise', 'novelty'

→ more than reward: 'reward minus expected reward'

→ involved in drug addiction

Games and social networks try to make participants/users addicted by stimulating the 'intrinsic reward system'.

Example: - decrease the expected reward for some time, and return then back to 'normal' reward back.

- add a stochastic component

- bonus points / reach next level

$$\delta = [r_t + \gamma V(s') - V(s)]$$

Previous slide.

The three factor rule, dopamine, TD signals, value functions now all fit together.

5. Summary

Learning outcome: RL learning rules and the brain

- **three-factor learning rules can be implemented by the brain**
 - synaptic changes need presynaptic factor, postsynaptic factor and a neuromodulator (3rd factor)
 - actor-critic and other policy gradient methods give rise to very similar three-factor rules
- **eligibility traces as ‘candidate parameter updates’**
 - set by joint activation of pre- and postsynaptic factor
 - decay over time
 - transformed in weight update if dopamine signal comes
- **the dopamine signal has signature of the TD error**
 - responds to reward minus expected reward
 - responds to unexpected events that predict reward
- **addiction hijacks the dopamine reward system**

Reading for this week:

Sutton and Barto, Reinforcement Learning (MIT Press, 2nd edition 2018, also online)

Chapter: 15

Background reading:

(1) *Fremaux, Sprekeler, Gerstner (2013)* Reinforcement learning using a continuous-time actor-critic framework with spiking neurons
PLoS Computational Biol. doi:10.1371/journal.pcbi.1003024

(2) *Gerstner et al. (2018)* Eligibility traces and plasticity on behavioral time scales: experimental support for neoHebbian three-factor learning rules, *Frontiers in neural circuits*
<https://doi.org/10.3389/fncir.2018.00053>

(3) *Wolfram Schultz et al., (1997)* A neural substrate of prediction and reward, *SCIENCE*,
<https://www.science.org/doi/full/10.1126/science.275.5306.1593>

(4) *Wolfram Schultz (2002)* Getting formal with dopamine and reward *Neuron* 36 (2), 241-263
<https://www.sciencedirect.com/science/article/pii/S0896627302009674>

[] At least 60 percent of the material was new to me

[] I have the feeling that I understood 80 percent or more

[] Even though I study CS/Math/Physics/EE, I found the links to learning in biology interesting

THE END